



KOBELCO

Arc Welding of Specific Steels and Cast Irons

KOBE STEEL, LTD.

KOBELCO



**Arc Welding of
Specific Steels and Cast Irons**

KOBE STEEL, LTD.

Published by **KOBE STEEL, LTD.**

© 2015 by **KOBE STEEL, LTD.**
5-912, Kita-Shinagawa, Shinagawa-Ku, Tokyo
141-8688 Japan

All rights reserved. No part of this book may be reproduced, in any form or by any means, without permission in writing from the publisher.

The *Arc Welding of Specific Steels and Cast Irons* provides information to assist welding personnel study the arc welding technologies applied in specific steels and cast irons.

Reasonable care is taken in the compilation and publication of this textbook to insure authenticity of the contents. No representation or warranty is made as to the accuracy or reliability of this information.

Introduction

Arc welding is currently used for fabrication and construction of a variety of structures such as buildings, bridges, ships, offshore structures, boilers, storage tanks, pressure vessels, pipelines, automobiles, and railroad vehicles. These structures use various types of steels and cast irons suitable for their specific applications. Different metals inherently possess different weldability. Some metals are readily weldable, but some are difficult to weld, which require specific welding procedures. Personnel in charge of welding, therefore, should have sufficient knowledge of the specific welding technologies required for welding specific metals in order to fabricate and construct various structures successfully. The *Arc Welding of Specific Steels and Cast Irons* has been published as a welding technology guide for studying the weldability of specific steels and cast irons and proper welding procedures. This guidebook contains many figures in order to help the readers understand the specific welding technologies. The information contained in this guidebook includes those from the references listed below. This guidebook consists of five chapters:

- Chapter 1: Arc Welding of High-Strength Steel
- Chapter 2: Arc Welding of Heat-Resistant Low-Alloy Steel
- Chapter 3: Arc Welding of Stainless Steel
- Chapter 4: Arc Welding of Cast iron
- Chapter 5: Arc Welding for Hardfacing

References

- (1) The Association for Training Engineers of Smaller Enterprises in Japan, "Welding of High-Strength Steel," Utilization of Welding Technology, 1984
- (2) H. Ikawa, T. Godai, "Welding of Heat-Resistant Steel and Heat-Resistant Materials," The Complete Book of Welding — Series 4, 1978, Sanpo Publications Inc.
- (3) American Petroleum Institute, "Steels for Hydrogen Service at Elevated Temperatures and Pressures in Petroleum Refineries and Petrochemical Plants," API Recommended Practice 941, Fifth Edition, January 1997, Supplement 1 April 1998
- (4) O. Tanaka, "Welding of Stainless Steel and Characteristics of the Welds," Welding Technique, 1986, The Japan Welding Engineering Society, Sanpo Publications Inc.
- (5) Kobe Steel, Ltd., "Electrode Handbook," 1964
- (6) American Welding Society, "Welding Handbook," Eighth Edition, Vol. IV, 1998; Vol. I, 1987
- (7) American Welding Society, "Welding Encyclopedia," 18th Edition, 1997

Arc Welding of High Strength Steel

Contents

1. Types and features of high strength steels	1-2
2. Weldability of high strength steels	1-7
2.1 Hardenability of welds	1-7
2.2 Weld cracks	1-9
3. Welding processes and procedures	1-16
3.1 Shielded metal arc welding	1-16
3.2 Submerged arc welding	1-23
3.3 Gas shielded metal arc welding	1-27
3.4 Gas tungsten arc welding	1-29

1. Types and features of high-strength steels

High-strength steel is used in a variety of steel structures such as ships, bridges, buildings, pressure vessels, storage tanks, penstocks, pipelines, autos, and railroad vehicles in order to allow the steel structures to have higher design strengths. High-strength steels have higher tensile strengths and higher yield strengths with larger yield ratios (the ratio of yield strength to tensile strength) than mild steel, as shown in Fig. 1.1, thereby facilitating higher design strengths. High-strength steels can be referred to as a family of steels having yield strengths of 275 MPa (28 kgf/mm²) or higher and tensile strengths of 490 MPa (50 kgf/mm²) or higher.

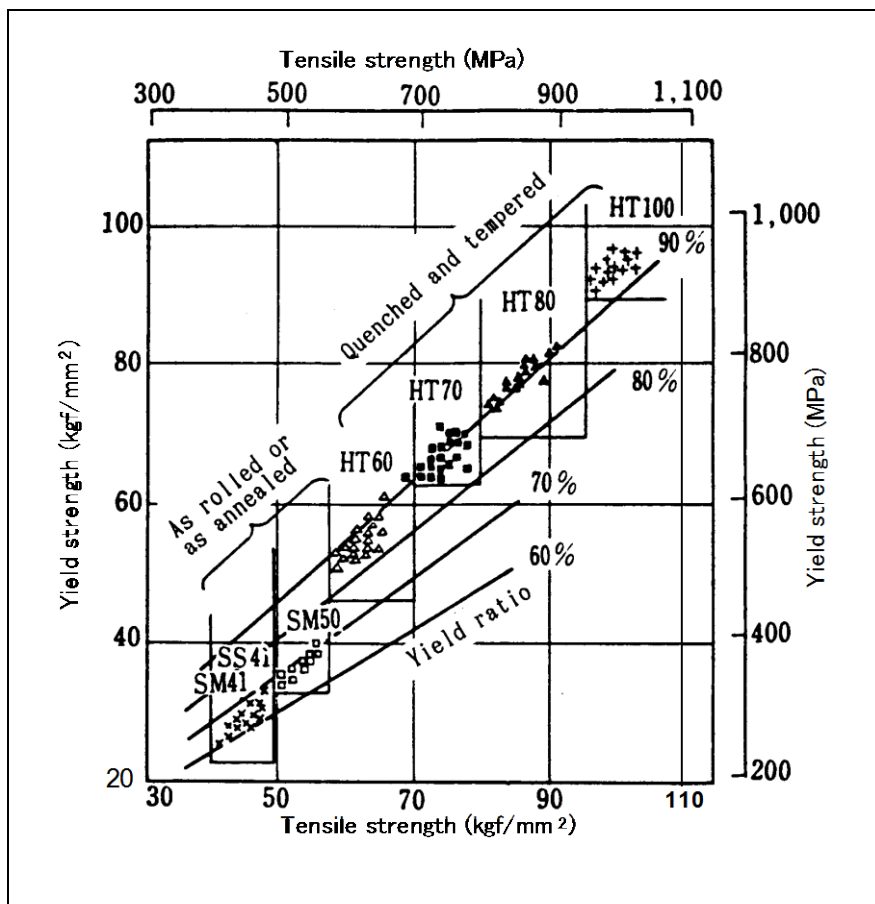

Fig. 1.1 — Relationship between tensile strength, yield strength, and yield ratio of steel materials

With high-strength steels, structures can be designed to have larger scales or thinner thicknesses due to the ability of sustaining larger applied stresses when compared with mild steel. Table 1.1 shows how the use of high-strength steel can make steel structures thinner or lighter. The use of 490-MPa high-tensile strength steel, for example, can reduce the weight of a steel structure by 25% in comparison with the use of mild steel under the same design stress. The weight ratios shown in Table 1.1 are calculated in accordance with the following formula.

$$\text{Weight ratio} = \frac{\text{Minimum yield strength of mild steel}}{\text{Minimum yield strength of high-strength steel}}$$

Table 1.1 — The possibility of weight reduction of steel structures by using high-strength steels in comparison with mild steel under the same design strength

Type of steel ⁽¹⁾	Min. yield strength ⁽²⁾ (MPa)	Weight ratio	Weight reduction ratio (%)
Mild steel: JIS SM400A	235	1.00	0
490-MPa HT: JIS SM490A	315	0.75	25
570- MPa HT: JIS SM570	450	0.52	48
610- MPa HT: WES HW490	490	0.48	52
780- MPa HT: WES HW685	685	0.34	66

Note:

(1) “HT” stands for “High Tensile.”

(2) The minimum yield strengths of SM400A, SM490A and SM570 are those of the steel plates in the thickness range of 16-40 mm as per JIS G 3106:2008 (Rolled Steels for Welded Structure) The minimum yield strengths of HW490 and HW685 are those of the steel plates with a maximum thickness of 75 mm as per WES 3001:2012 (Weldable High Strength Steel Plates).

In the production of high-strength steels, the alloying elements (C, Mn, Ni, Cr, Mo, V, Nb, Cu, Ti, B, etc.) are added and heat treatment is applied in order to provide adequate tensile strengths, yield strengths, ductility, and notch toughness to the requirements of the relevant standards and specifications. The heat treatment includes normalizing, normalizing followed by tempering, and quenching followed by tempering. In addition, high-strength steels are often produced by using specially controlled thermal and rolling sequences known as the Thermo-Mechanical Control Process (TMCP). The TMCP steels offer higher strengths with lower carbon equivalent and superior weldability.

High-strength steels can be classified by the minimum tensile strength (for example, 490, 570, 610, and 780 MPa classes). Some standards and specifications, however, classify high-strength steels by the minimum yield strength. **Table 1.2** shows the JIS standard for high-strength steels in which steels are classified by the minimum tensile strength. **Tables 1.3** and **1.4** show the standards for high-strength steels classified by the minimum yield strength, which are specified by the Japan Welding Engineering Society (JWES) and the American Petroleum Institute (API), respectively.

Some classes of high-strength steels offer superior notch toughness at low temperatures, which are utilized for low-temperature equipment such as LPG carriers, LPG storage tanks, and offshore structures. This type of steel is also known as low-temperature steel. High-strength steels include special classes that offer higher corrosion resistance under the atmospheric conditions, which are known as weatherproof steels and are utilized in bridges and buildings constructed in industrial and seashore areas.

Table 1.2 — Chemical and mechanical requirements for rolled steels for welded structures (JIS G 3106:2008)

Class	Chemical composition (%) (1)(2) T: plate thickness					S	0.2% yield strength (N/mm ²) T: plate thickness				Tensile strength (N/mm ²) Plate thickness: ≥ 100mm	Charpy impact test	
	C	Si	Mn	P	T ≤ 16 mm		16 < T ≤ 40 mm	40 < T ≤ 75 mm	75 < T ≤ 100 mm	Test temperature (°C)		Absorbed energy (J)	
SM490A	0.20 max. (T ≤ 50mm)												
	0.22 max. (50 < T ≤ 200mm)	0.55 max.	1.65 max.	0.035 max.	0.035 max.	0.035 max.	325 min.	315 min.	295 min.	295 min.	490 - 610	—	—
SM490B	0.18 max. (T ≤ 50mm)												
	0.20 max. (50 < T ≤ 200mm)											0	27 min.
SM490C	0.18 max. (T ≤ 100mm)											0	47 min.
SM490YA	0.20 max. (T ≤ 100mm)	0.55 max.	1.65 max.	0.035 max.	0.035 max.	0.035 max.	365 min.	355 min.	335 min.	325 min.	490 - 610	—	—
SM490YB	0.20 max. (T ≤ 100mm)	0.55 max.	1.65 max.	0.035 max.	0.035 max.	0.035 max.	365 min.	355 min.	335 min.	325 min.	520 - 640	0	27 min.
SM520B	0.20 max. (T ≤ 100mm)	0.55 max.	1.65 max.	0.035 max.	0.035 max.	0.035 max.	365 min.	355 min.	335 min.	325 min.	520 - 640	0	27 min.
SM520C	0.20 max. (T ≤ 100mm)	0.55 max.	1.65 max.	0.035 max.	0.035 max.	0.035 max.	365 min.	355 min.	335 min.	325 min.	520 - 640	0	47 min.
SM570	0.18 max. (T ≤ 100mm)	0.55 max.	1.70 max.	0.035 max.	0.035 max.	0.035 max.	460 min.	450 min.	430 min.	420 min.	570 - 720	-5	47 min.

Note:

(1) Other alloying elements can be added if needed.

(2) For SM570 steel, the following carbon equivalent shall be 0.44 max. for plates with a thickness of 50mm max; 0.47 max. for plates with a thickness of over 50mm and up to 100mm. Ceq (%) = C + 1/6Mn + 1/24Si + 1/40Ni + 1/5Cr + 1/4Mo + 1/14V.

In lieu of the carbon equivalent, the following cracking parameter of material (Pcm) shall be 0.28 max. for plates with a thickness of up to 50mm; 0.30 max. for plates with a thickness of over 50mm and up to 100mm.

Pcm (%) = C + 1/30Si + 1/20Mn + 1/20Cr + 1/60Ni + 1/20Cr + 1/15Mo + 1/10V + 5B

For other classes, when TMCP-treated upon agreement between supplier and purchaser, Ceq or Pcm is specified separately.

Table 1.3 — Chemical and mechanical requirements for weldable high-strength steel plates (WES 3001:2012)

Class	Chemical composition (%)			Yield strength (N/mm ²) ⁽²⁾	Tensile strength (N/mm ²) ⁽²⁾	Charpy impact test			P _{cm} ⁽¹⁾				
	C	P	S			Plate thickness (mm)	Test temp. (°C)	Absorbed energy (J)	A-grade ⁽⁴⁾		B-grade ⁽⁴⁾		
									QT	TMC	AR or N	QT	TMC
HW355	0.20 max	0.030 max	0.025 max	355 min	520-640	6 ≤ T < 12	+10	(3)	0.26 max	0.26 max	0.32 max	0.24 max	0.24 max
							+10						
							0						
							-5						
							-15						
							+10						
HW390	0.20 max	0.030 max	0.025 max	390 min	560-680	12 ≤ T ≤ 20	+10	(3)	0.27 max	0.27 max	0.34 max	0.25 max	0.25 max
							0						
							-5						
							-15						
							+10						
							+10						
HW450	0.18 max	0.030 max	0.025 max	450 min	590-710	20 < T ≤ 32	+5	(3)	0.28 max	0.28 max	0.35 max	0.26 max	0.26 max
							-5						
							-10						
							-20						
							0						
							+5						
HW490	0.18 max	0.030 max	490 min	610-730	32 < T ≤ 50	50 < T ≤ 150	-20	(3)	0.28 max	0.28 max	0.39 max	0.26 max	0.26 max
							0						
							-5						
							-15						
							-25						
							0						

Note:

(1) P_{cm} = C + Si/30 + Mn/20 + Cu/20 + Ni/60 + Cr/20 + Mo/15 + V/10 + 5B (only for T ≤ 50 mm; for other plate thicknesses, refer to the specification.)

(2) Tensile properties are for T ≤ 75 mm. Refer to the specification for other plate thicknesses.

(3) For 6 ≤ T ≤ 8mm: 24J min, using 1/2 sub-size specimens

For 8 < T ≤ 10.5mm: 35J min, using 3/4 sub-size specimens

For 10.5 < T < 12mm: 39J min, using 3/4 sub-size specimens

(4) A-grade is for general uses, while B-grade is for the applications where more careful measures are needed to prevent cold cracking.

QT: Quenching and subsequent tempering, TMC: Thermo-mechanical control, AR: As-rolled, N: Normalizing

Table 1.3 (cont.) — Chemical and mechanical requirements for weldable high-strength steel plates (WES 3001:2012)

Class	Chemical composition (%)		Yield strength (N/mm ²) ⁽²⁾	Tensile strength (N/mm ²) ⁽²⁾	Charpy impact test			Pcm ⁽¹⁾											
	C	P			S	Plate thick. (mm)	Test temp. (°C)	Absorbed energy (J)	A-grade ⁽⁴⁾		B-grade ⁽⁴⁾								
									QT	TMC	QT	TMC							
HW550	0.18 max	0.030 max	0.025 max	670-800	6 ≤ T < 12	0	(3)												
					12 ≤ T ≤ 20	0	47 min												
					20 < T ≤ 32	-10	47 min												
					32 < T ≤ 50	-20	47 min												
					50 < T ≤ 150	-30	47 min												
HW620	0.18 max	0.030 max	0.025 max	710-840	6 ≤ T < 12	-5	(3)												
					12 ≤ T ≤ 20	-5	47 min												
					20 < T ≤ 32	-15	47 min												
					32 < T ≤ 50	-20	47 min												
					50 < T ≤ 100	-30	47 min												
HW685	0.18 max	0.025 max	0.020 max	780-930	6 ≤ T < 12	-10	(3)												
					12 ≤ T ≤ 20	-10	47 min												
					20 < T ≤ 32	-20	47 min												
					32 < T ≤ 50	-25	47 min												
					50 < T ≤ 100	-35	47 min												
HW785	0.18 max	0.025 max	0.020 max	880-1030	6 ≤ T < 12	-15	(3)												
					12 ≤ T ≤ 20	-15	47 min												
					20 < T ≤ 32	-25	47 min												
					32 < T ≤ 50	-30	47 min												
					50 < T ≤ 100	-40	47 min												
HW885	0.18 max	0.025 max	0.020 max	950-1130	6 ≤ T < 12	-25	(3)												
					12 ≤ T ≤ 20	-25	47 min												
					20 < T ≤ 32	-30	47 min												
					32 < T ≤ 50	-40	47 min												
					50 < T ≤ 100	-50	47 min												

Note: (1) Pcm = C + Si/30 + Mn/20 + Cu/20 + Ni/60 + Cr/20 + Mo/15 + V/10 + 5B (only for T ≤ 50 mm; for other plate thicknesses, refer to the specification.)
 (2) Tensile properties are for T ≤ 75 mm. Refer to the specification for other plate thicknesses.
 (3) For 6 ≤ T ≤ 8mm: 24J min, using 1/2 sub-size specimens; For 8 < T ≤ 10.5mm: 35J min, using 3/4 sub-size specimens
 For 10.5 < T < 12mm: 39J min, using 3/4 sub-size specimens
 (4) A-grade is for general uses, while B-grade is for the applications where more careful measures are needed to prevent cold cracking.
 QT: Quenching and subsequent tempering, TMC: Thermo-mechanical control, AR: As-rolled, N: Normalizing

Table 1.4 — Specification for high-strength line pipes (API 5L-2004)

Class ⁽¹⁾	Chemical composition (%)					Yield strength (MPa)	Tensile strength (MPa)
	C	Mn	P	S	Ti		
X56	0.22 max	1.40 max	0.025 max	0.015 max	0.04 max	386-544	490-758
X60	0.22 max	1.40 max	0.025 max	0.015 max	0.04 max	414-565	517-758
X65	0.22 max	1.45 max	0.025 max	0.015 max	0.06 max	448-600	531-758
X70	0.22 max	1.65 max	0.025 max	0.015 max	0.06 max	483-621	565-758
X80	0.22 max	1.85 max	0.025 max	0.015 max	0.06 max	552-690	621-827

Note: (1) The process of manufacture and product specification level: PSL 2.

2. Weldability of high-strength steels

Weldability can be defined as the ease of obtaining satisfactory welding results. Satisfactory welding should result in sound welds with acceptable chemical and mechanical properties as well as reasonable welding costs. A sound weld should not contain welding defects such as hot and cold cracks, incomplete fusion, lack of fusion, overlap, excessive porosity, and undercut. An acceptable weld should have the sufficient tensile strength, yield strength, ductility, notch toughness, atmospheric corrosion resistance required for the intended application. Welding costs should be reasonable. In welding high-strength steels, the weld becomes hard with low ductility because of their inherent self-hardenability, contains diffusible hydrogen, and is subject to restraint stresses. These three factors of low ductility, diffusible hydrogen and restraint stress often cause cracks in the weld metal and the heat-affected zone. Therefore, the weldability of the high-strength steel and the welding consumable to be used should thoroughly be examined to establish the welding procedure.

2.1 Hardenability of welds

High-strength steels contain larger amounts of alloying elements than mild steel; consequently, the heat-affected zone of high-strength steels becomes harder by rapid cooling in welding. **Fig. 2.1** shows a Continuous Cooling Transformation Curve for 590-MPa high-tensile strength steels. This curve illustrates how the cooling rate from the austenitic state affects the microstructure and hardness of the simulated heat-affected zone of the steel. **Fig. 2.2** illustrates this relationship more clearly. That is, as the cooling time becomes shorter or the cooling rate increases, the microstructure contains a higher percentage of martensite structure with higher hardness. This hardenability of the heat-affected zone is also affected by the carbon equivalent of the steel, as shown in **Fig. 2.3** in which the cooling rate is kept constant. It is apparent that the maximum hardness of the heat-affected zone increases as the carbon equivalent increases. This suggests that the maximum hardness of 610-MPa high-tensile strength steels (e.g. HW490) can be as high as Hv420 on average in its heat-affected zone caused by welding. Its non-heat-affected zone may be as low as around Hv240.

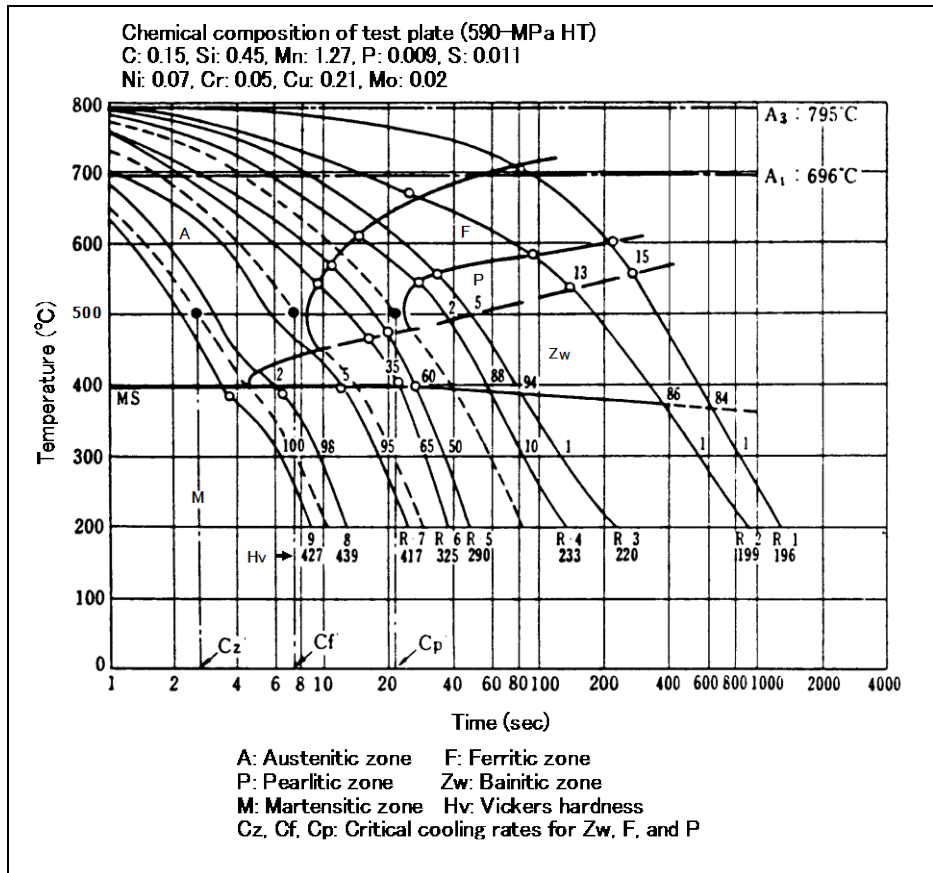

Fig. 2.1 — A Continuous Cooling Transformation Curve for 590-MPa high-tensile strength steel (the heating temperature of specimens: 1350°C)

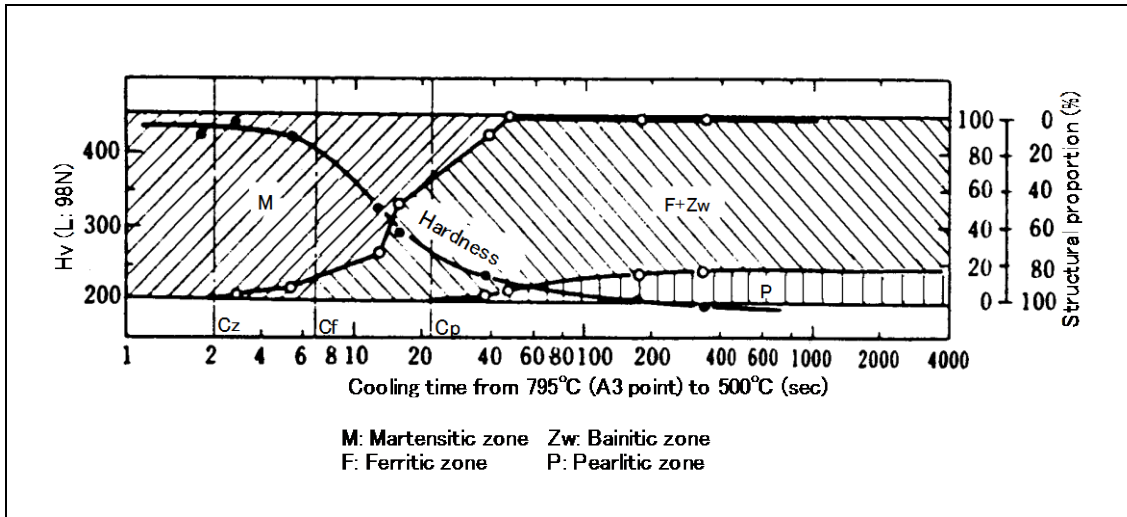

Fig. 2.2 — Relationship between hardness, structure, and cooling time from 795°C (A3 point) to 500°C for 590-MPa high-tensile strength steel

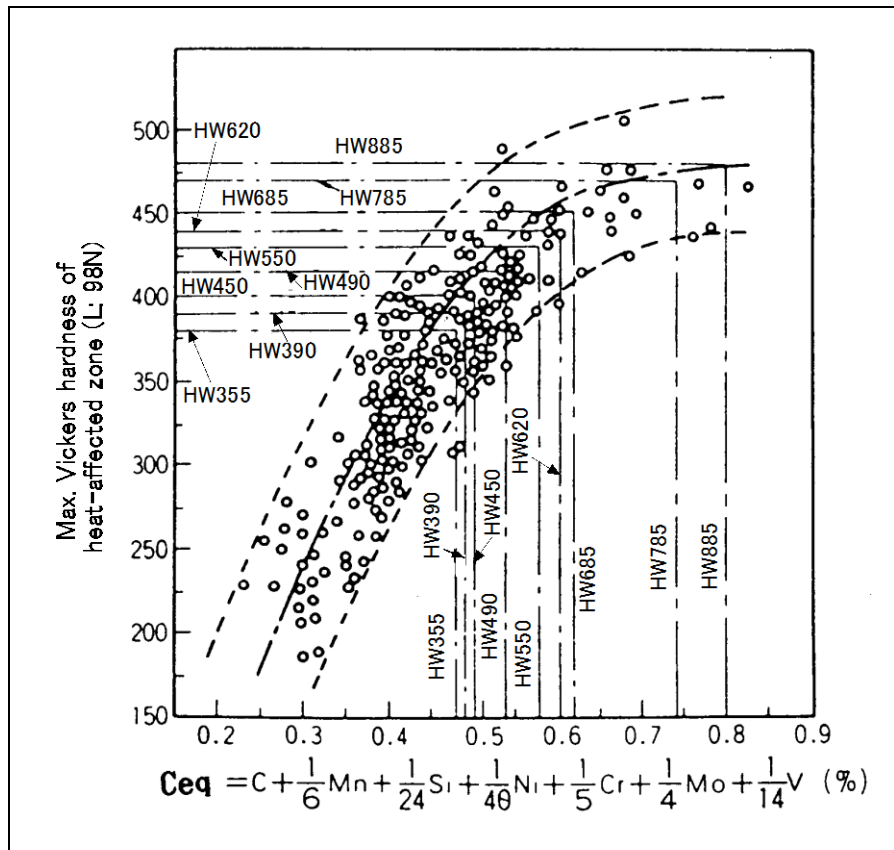

Fig. 2.3 — Relationship between carbon equivalent (C_{eq}) of high-strength steels and the maximum hardness of the heat-affected zones under the following test conditions:

- Plate thickness: 20 mm
- Cooling rate: 28°C/sec at 540°C
- Cooling time: 6 sec from 800 to 500°C

2.2 Weld cracks

2.2.1 Types and features of cracks

One of the worst weld defects is cracking. There are several types of weld cracks. **Table 2.1** shows various types and features of the weld cracks that are apt to occur in welding high-strength steels. Cold cracks can occur in welds at the temperatures, generally, below 200°C. Low ductility of welds, diffusible hydrogen and restraint stresses in welds are believed to be the three major causes of cold cracking. Hot cracks may occur in welds at the high temperatures adjacent to the solidification point of the metal where the ductility of the metal is not sufficient to accommodate the stresses raised by the contraction of the weld being solidified. Impurities such as sulfur and phosphorus having low melting points accelerate hot cracking. In addition to cold and hot cracking, reheat cracking (SR cracking), stress corrosion cracking, and fatigue cracking may occur in high-strength steel welds under specific conditions.

Table 2.1 — Types and features of weld cracks







Type of crack	Crack initiation	Crack appearance	Causes of crack occurrence
Cold crack	Root crack	<ul style="list-style-type: none"> • HAZ • Weld metal 	<ol style="list-style-type: none"> (1) Hydrogen in welds (2) Brittle weld (3) Concentrated stress
	Longitudinal crack	<ul style="list-style-type: none"> • HAZ • Weld metal 	<ol style="list-style-type: none"> (1) Hydrogen in welds (2) Brittle weld (3) Restraint stress
	Transverse crack	<ul style="list-style-type: none"> • HAZ • Weld metal 	<ol style="list-style-type: none"> (1) Hydrogen in welds (2) Brittle weld (3) Restraint stress
	Underbead crack	<ul style="list-style-type: none"> • HAZ 	<ol style="list-style-type: none"> (1) Hydrogen in welds (2) Brittle HAZ
	Toe crack	<ul style="list-style-type: none"> • HAZ 	<ol style="list-style-type: none"> (1) Hydrogen in welds (2) Brittle HAZ (3) Concentrated stress
	Heel crack	<ul style="list-style-type: none"> • HAZ 	<ol style="list-style-type: none"> (1) Hydrogen in welds (2) Brittle HAZ (3) Concentrated stress
	Lamellar tear	<ul style="list-style-type: none"> • HAZ • Base metal 	<ol style="list-style-type: none"> (1) Inadequate ductility of base metals in the plate thickness direction (2) High sulfur content in base metals (3) Non-metallic inclusions in base metals (4) Hydrogen in welds (5) Restraint stress

Table 2.1 (cont.) — Types and features of weld cracks

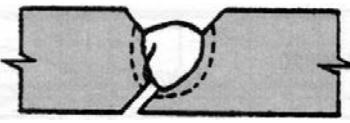
Type of crack		Crack initiation	Crack appearance	Causes of crack occurrence
Hot crack	Inter-crystalline micro-crack	<ul style="list-style-type: none"> • HAZ • Weld metal 		<ol style="list-style-type: none"> (1) Segregation of S and P at grain boundaries (2) Brittleness of welds at around 1000°C
	Crater crack	<ul style="list-style-type: none"> • Weld metal 		<ol style="list-style-type: none"> (1) Segregation of S and P in the weld metal craters (2) Shrinkage cavity in the crater of a weld metal
	Pear-shape crack	<ul style="list-style-type: none"> • Weld metal 		<ol style="list-style-type: none"> (1) Segregation of S and P in weld metals (2) Pear-shape weld metal with a small width-to-depth ratio

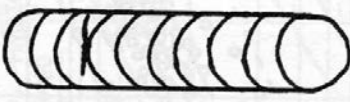
2.2.2 Crack sensitivity

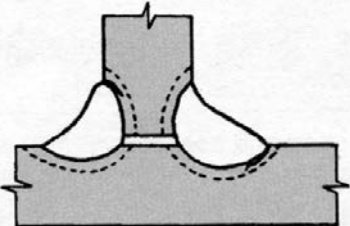
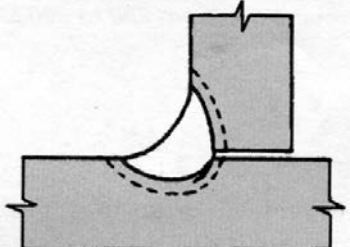
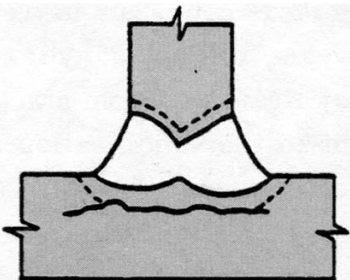
The hot and cold crack sensitivity of welds can be tested by several different methods, which use butt welding or fillet welding. Table 2.2 outlines crack sensitivity test methods specified by the Japanese Industrial Standard. Fig. 2.4 shows crack sensitivity test results of 780-MPa high-tensile strength welds tested by means of the y-groove cracking test using several preheating temperatures. The figure clearly shows that preheating the base metal at 150°C as minimum is necessary to prevent cold cracking in the weld.

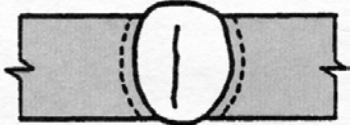
The carbon equivalent of a base metal and the hardness of its heat-affected zone have generally been used to estimate the crack sensitivity of the weld. Nowadays, the following formula is also used to estimate the crack sensitivity of high-strength steel welds. This formula is derived from the y-groove cracking test results, using various high-strength steels. This formula includes the thickness of the base metal and the hydrogen content of the deposited metal, in addition to the factor of chemical composition.

$$P_c = C + Si/30 + Mn/20 + Cu/20 + Ni/60 + Cr/20 + Mo/20 + V/10 + 5B + t/600 + H/60$$

where P_c : cracking parameter,

t : plate thickness (mm)

H : diffusible hydrogen (ml/100g) in the deposited metal (determined by using the glycerol method).

By determining the cracking parameter (P_c), the preheating temperature to prevent cold cracking can be derived from Fig. 2.5 or by the formula shown below:

$$T = 1400 \times P_c - 392$$

where T : preheating temperature (°C) to prevent cold cracking.

Table 2.2 — Outlines of crack sensitivity test methods

Type of crack	Type of weld	
	Butt weld	Fillet weld
Cold crack	(1) U-groove weld cracking test (JIS Z 3157:1993) (2) y-groove weld cracking test (JIS Z 3158:1993) (3) H-type restrained weld cracking test (JIS Z 3159:1993)	Controlled thermal severity (CTS) weld cracking test (JIS Z 3154:1993)
Hot crack	FISCO test (JIS Z 3155:1993)	T-joint weld cracking test (JIS Z 3153:1993)

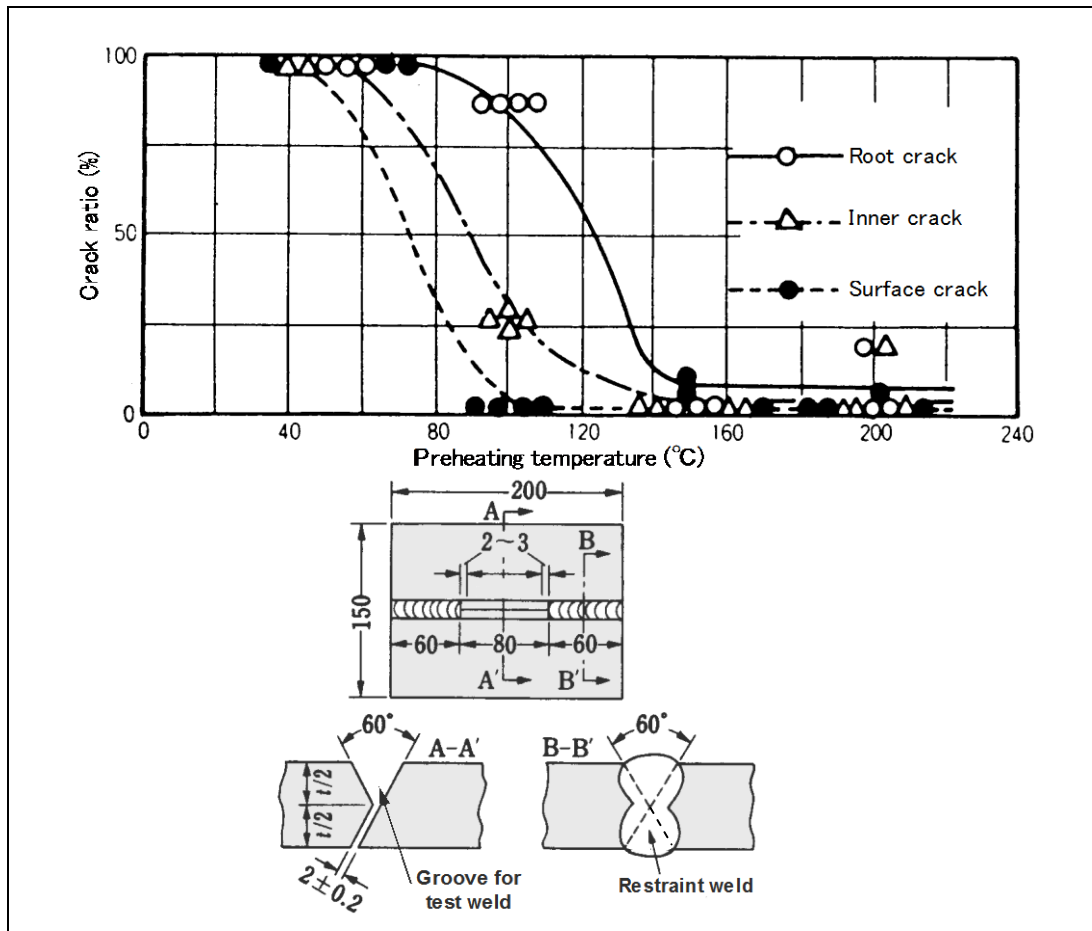

Fig. 2.4 — y-groove weld cracking test results of 780-MPa high-tensile strength steel welds

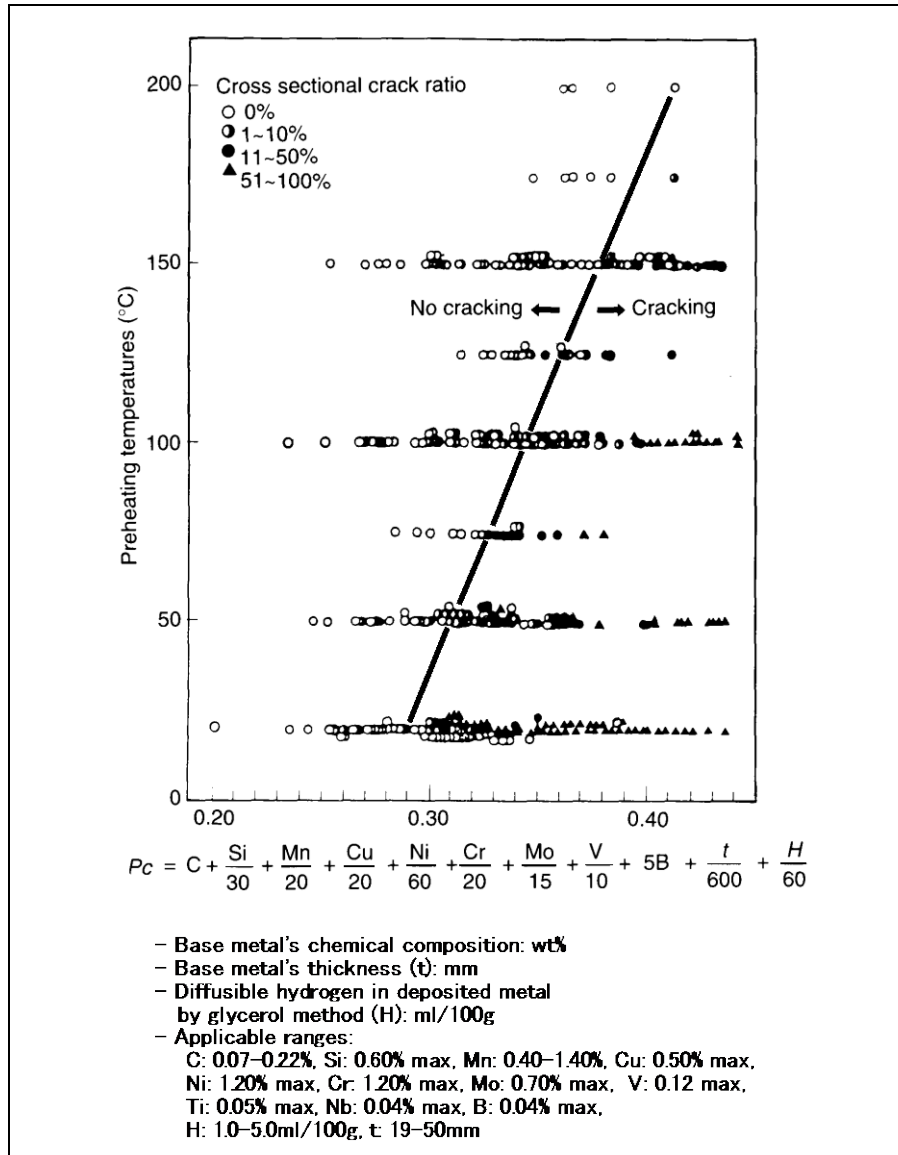

Fig. 2.5 — Relationship between the cracking parameter (P_c) and the preheating temperature to prevent cold cracking in welds (Source: WES 3001:1996 Exposition)

2.2.3 Diffusible hydrogen

Hydrogen can readily be absorbed by molten metal during welding. The primary source of hydrogen is the moisture that is contained in the atmosphere, absorbed by the welding consumable, and deposited on the fusion surfaces of the base metal. It is well known that the hydrogen dissolved in a weld metal diffuses in the weld metal and the heat-affected zone of the base metal; this diffusible hydrogen may cause blowholes and cracks (hydrogen-assisted cracking) in the weld. The occurrence of hydrogen-assisted cracking is affected by diffusible hydrogen in the weld, residual stresses in the weld, and the cooling rate and chemical composition of the weld. The amount of diffusible hydrogen in a weld metal varies according to the water vapor pressure of the atmosphere, as shown in **Fig. 2.6**. This figure illustrates that the amount of diffusible hydrogen in a 590-MPa high-tensile strength weld metal made with a low-hydrogen type covered electrode increases as the water vapor pressure of the atmosphere and the amount of moisture in the covered electrode increase.

In submerged arc welding, the water vapour pressure of the atmosphere has little effect on the amount of diffusible hydrogen in the weld metal, because the arc is covered with the flux. However, absorbed moisture in the flux increases the amount of diffusible hydrogen in the weld metal.

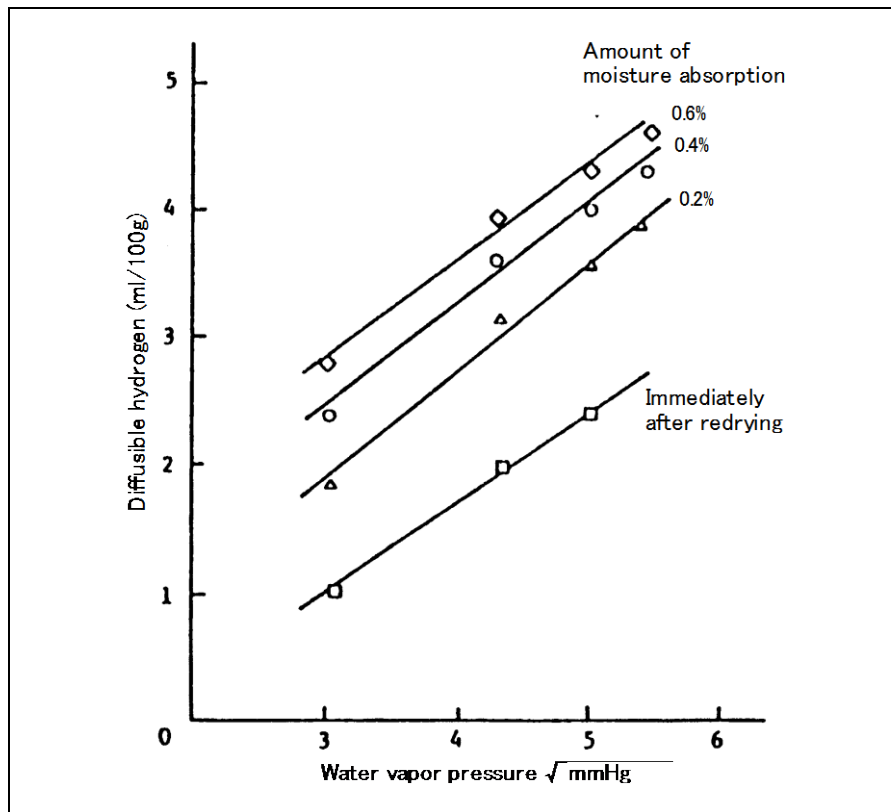

Fig. 2.6 — Relationship between the amount of diffusible hydrogen in a deposited metal and the vapor pressure of the testing atmosphere (1 mmHg = 133 Pa)

The diffusible hydrogen adversely affects weldability, as mentioned above. To improve this, low, extra-low and ultra-low hydrogen covered electrodes have been developed to decrease the level of diffusible hydrogen in weld metals. For details of these advanced electrodes, refer to Section 3.1.1.

The amount of diffusible hydrogen in weld metals increases as the covered electrode absorbs moisture. **Fig. 2.7** shows test results of the moisture absorption of low-hydrogen type covered electrodes with two different coatings (one is conventional type, and the other is moisture-resistant type) exposed to a controlled temperature-humidity atmosphere. It apparently shows that as the exposure time increases the amounts of absorbed moisture in the covered electrodes increase; however, the moisture-resistant type electrode absorbs less moisture than does the conventional type electrode. **Fig. 2.8** shows the relationship between exposure time and the diffusible hydrogen content of the weld metals made with the above-mentioned moisture-resistant and conventional covered electrodes. It reveals that the moisture-resistant type covered electrode can keep the diffusible hydrogen content lower in comparison with the conventional type electrode.

The lower the diffusible hydrogen, the lower the crack susceptibility, as is suggested by **Fig. 2.5**. Any covered electrodes, however, should be kept dry in order to minimize moisture absorption, thereby minimizing diffusible hydrogen in the weld metal.

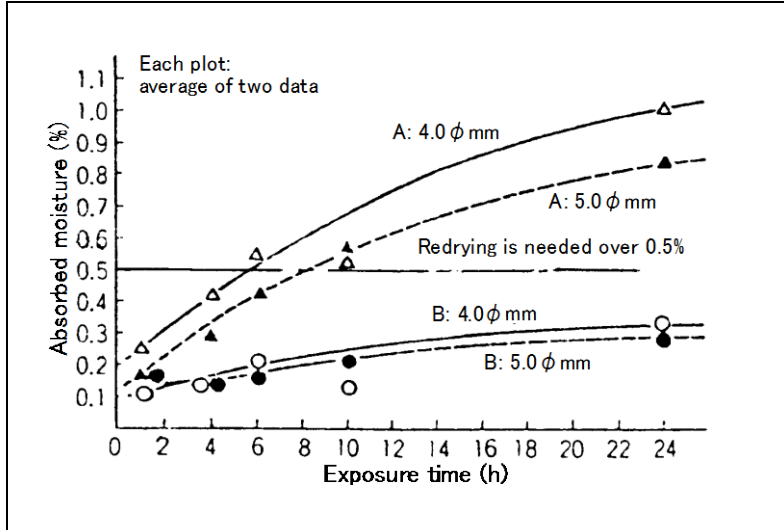

Fig. 2.7 — Results of moisture-absorption test with 490-MPa HT low-hydrogen covered electrodes:
A: Conventional low-hydrogen type
B: Moisture-resistant low-hydrogen type

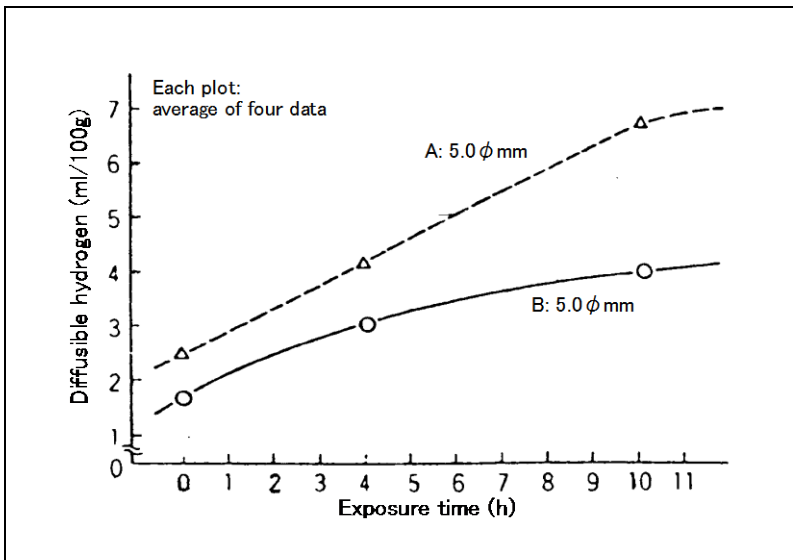

Fig. 2.8 — Relationship between diffusible hydrogen in the weld metals made with 490-MPa HT low-hydrogen type covered electrodes and electrode exposure time to the testing atmosphere (26°C-85%RH)
A: Conventional low-hydrogen type
B: Moisture-resistant low-hydrogen type

3. Welding processes and procedures

In order to get a satisfactory result in welding high-strength steels, suitable welding consumables should be selected and appropriate welding processes and procedures should be used. As shown in **Table 3.1**, applicable welding processes for 490- to 980-MPa high-tensile strength steels are those of shielded metal arc welding, submerged arc welding, gas shielded metal arc welding, and gas tungsten arc welding.

Table 3.1 — Welding processes for high-strength steels

Welding process	Type of high-strength steel				
	490-MPa HT	610-MPa HT	690-MPa HT	780-MPa HT	980-MPa HT
Shielded metal arc welding	◎	◎	◎	◎	○
Submerged arc welding	◎	◎	◎	◎	○
Gas shielded metal arc welding	◎	◎	◎	◎	◎
Gas tungsten arc welding	○	○	○	○	◎
Electroslag welding	○	△	—	—	—
Electrogas welding	○	△	—	—	—

Note: ◎: Widely used; ○: Used; △: Occasionally used; —: Not used.

3.1 Shielded metal arc welding

3.1.1 Types and features of covered electrodes

Covered electrodes for welding high-strength steels should satisfy the following general requirements:

- a) The weld metal satisfies the mechanical properties (tensile strength, ductility, notch toughness) required by the relevant standards and specifications.
- b) Crack resistance of the weld metal is sufficient.
- c) Usability is good enough to make sound welds
- d) Welding efficiency is sufficiently high.

Various types of covered electrodes are available for welding high-strength steels, as shown in **Tables 3.2** and **3.3** referring to the Japanese Industrial Standard (JIS) and the American Welding Society (AWS) Standard, respectively.

Among low-hydrogen type covered electrodes, several advanced electrodes offer specific characteristics of moisture-resistance, extra-low hydrogen, ultra-low hydrogen, and less-hazardous fume. The moisture-resistant electrodes offer better resistance to moisture absorption as discussed above referring to Figs. 2.7 and 2.8. This type of electrode allows a longer hour use without redrying because of slower moisture pickup in the atmosphere. The amount of diffusible hydrogen (by glycerol method) with usual low-hydrogen electrodes is about 3-5 ml per 100g of weld metal. Extra-low-hydrogen electrodes offer lower diffusible hydrogen of approximately 1.5-3 ml/100g. Ultra-low-hydrogen electrodes are characterized by far lower diffusible hydrogen of about 0.5-1.5 ml/100g. The lower the diffusible hydrogen, the lower the crack susceptibility. The cold cracking test results, as shown in **Table 3.4**, reveal that with ultra-low hydrogen electrodes the preheating temperature can be lower than with extra-low hydrogen electrodes. Less-hazardous-fume electrodes, so called “clean rode,” emit fumes with improved chemistry and microscopic shape as compared with conventional electrodes.

Table 3.2 — Typical covered electrodes for high-strength steels (Excerpted from JIS Z 3211:2008)

Class ⁽¹⁾	Type of coating	Mechanical properties of deposited metal				Diffusible hydrogen ⁽²⁾ (ml/100g)
		Yield strength (MPa)	Tensile strength (MPa)	Elongation (%)	Charpy impact absorbed energy, average (J)	
E4916	Low hydrogen	400 min	490 min	20 min	27 min at -30°C	5, 10, or 15 max as applicable
E4918	Iron-powder low hydrogen					
E4928	Iron-powder low hydrogen					
E4948	Low hydrogen					
E4924	Iron-powder titania	400 min	490 min	16 min	—	—
E4910-P1	High cellulose	420 min	490 min	20 min	27 min at -30°C	—
E5510-P1	High cellulose	460 min	550 min	19 min	27 min at -30°C	—
E5516-3N3	Low hydrogen	460 min	550 min	17 min	27 min at -50°C	5, 10, or 15 max as applicable
E6216-N1M1	Low hydrogen	530 min	620 min	15 min	27 min at -20°C	
E6916-N3CM1	Low-hydrogen	600 min	690 min	14 min	27 min at -20°C	
E7816-N4CM2	Low-hydrogen	690 min	780 min	13 min	27 min at -20°C	

Note: (1) Classification system

•E: designates electrode.

•49, 55, 62, 69, and 78: indicate the minimum tensile strength of deposited metal in 10 MPa.

•10, 16, 18, 24, 28, and 48: indicate the type of covering flux.

•Suffix: indicates the main chemical composition of deposited metal.

(2) Testing method: JIS Z 3118:2007 (Measurement of Amount of Hydrogen Evolved from Steel Welds)

Table 3.3 — Typical covered electrodes for high-strength steels (Excerpted from AWS A5.1:2012 and A5.5:2014)

Class ⁽¹⁾	Type of coating	Mechanical properties of weld metal			
		Yield strength at 0.2% offset (ksi)	Tensile strength (ksi)	Elongation (%)	Charpy impact absorbed energy, average (ft-lbf)
E7016	Low hydrogen potassium	58 min	70 min	22 min	20 min at -20°F
E7018	Low hydrogen potassium, iron powder				
E7048	Low hydrogen potassium, iron powder				
E7024	Iron powder, titania	58 min	70 min	17 min	—
E7016-C2L	Low hydrogen potassium	57 min	70 min	22 min	20 min at -150°F
E7010-P1	High cellulose sodium	60 min	70 min	22 min	20 min at -20°F
E8010-P1	High cellulose sodium	67 min	80 min	19 min	20 min at -20°F
E8016-C1	Low hydrogen potassium	67 min	80 min	19 min	20 min at -75°F
E8016-C3	Low hydrogen potassium	68-80	80 min	24 min	20 min at -40°F
E8018-G	Low hydrogen potassium, Iron powder	67 min	80 min	19 min	—
E8018-W2	Low hydrogen potassium, Iron powder	67 min	80 min	19 min	20 min at -0°F
E9016-G	Low hydrogen potassium	77 min	90 min	17 min	—
E9018-G	Low hydrogen potassium, Iron powder				
E10016-G	Low hydrogen potassium	87 min	100 min	16 min	—
E11016-G	Low hydrogen potassium	97 min	110 min	15 min	—
E11018-G	Low hydrogen potassium, Iron powder				

Note: (1) Classification system

•E: designates electrode.

•70, 80, 90, 100, and 110: indicate the minimum tensile strength of weld metal in ksi.

•10, 16, 18, 24, and 48: indicate the welding position in which electrodes are usable, the type of covering, and the kind of welding current for which the electrodes are suitable.

•Suffix: designates the chemical composition of the undiluted weld metal.

Table 3.4 — Test results of y-groove cracking test

Type of steel	Drying condition for electrode	Type of electrode	Diffusible hydrogen level	Preheat temperature (°C)								
				0°C	25°C	50°C	75°C	100°C	125°C	150°C	175°C	
490-MPa HT: T = 25mm Ceq = 0.40 Pcm = 0.24	Right after redrying: 350°C x 1h	E7016	Extra-low						OO▲	OOO	OOO	
		E7016	Ultra-low				●●●	OOO	OOO	OOO		
	Right after 4h exposure to the atmosphere: 30°C x 80%RH	E7016	Extra-low							OO▲	OOO	O
		E7016	Ultra-low						●OO	OOO	OOO	
590-MPa HT: T = 38mm Ceq = 0.35 Pcm = 0.19	Right after redrying: 350°C x 1h	E9016-G	Extra-low	●●●	OOO	OOO						
		E9016-G	Ultra-low	OOO	OOO	OOO						
	Right after 4h exposure to the atmosphere: 30°C x 80%RH	E9016-G	Extra-low	●●●	●●●	OOO						
		E9016-G	Ultra-low	●▲O	OOO	OOO						
780-MPa HT: T = 40mm Ceq = 0.50 Pcm = 0.25	Right after redrying: 350°C x 1h	E11016-G	Extra-low				●●●▲	OOO				
		E11016-G	Ultra-low		●●●	●●▲	OOO					
	Right after 4h exposure to the atmosphere: 30°C x 80%RH	E11016-G	Extra-low									
		E11016-G	Ultra-low		●●●	●●▲	OOO					

Note:

O: No cracking; ▲: Half cracking; ●: Cracking through
 Ceq = C + 1/6 Mn + 1/24 Si + 1/40 Ni + 1/5 Cr + 1/4 Mo + 1/14 V
 Pcm = C + 1/30 Si + 1/20 Mn + 1/20 Cu + 1/60 Ni + 1/20 Cr + 1/15 Mo + 1/10 V + 5B
 Diffusible hydrogen by the JIS glycerol displacement method: extra-low: 1.5-3ml/100g; ultra-low: 0.5-1.5ml/100g;

3.1.2 Selection of covered electrodes

In welding high-strength steels, most welding joints are assembled with similar types of steels, but some, with dissimilar types of steels. In welding the similar-steel joints, the matching electrode having almost the same mechanical properties and chemical composition as those of the base metal should be chosen as shown in **Fig. 3.1**. In welding the dissimilar-steel joints, an electrode that matches either the base metal with higher tensile strength or the base metal with lower tensile strength can be selected. However, the electrode matching the base metal with lower tensile strength is used in general due to lower crack susceptibility and better usability. **Table 3.5** shows a quick guide to the electrodes for dissimilar-steel joints.

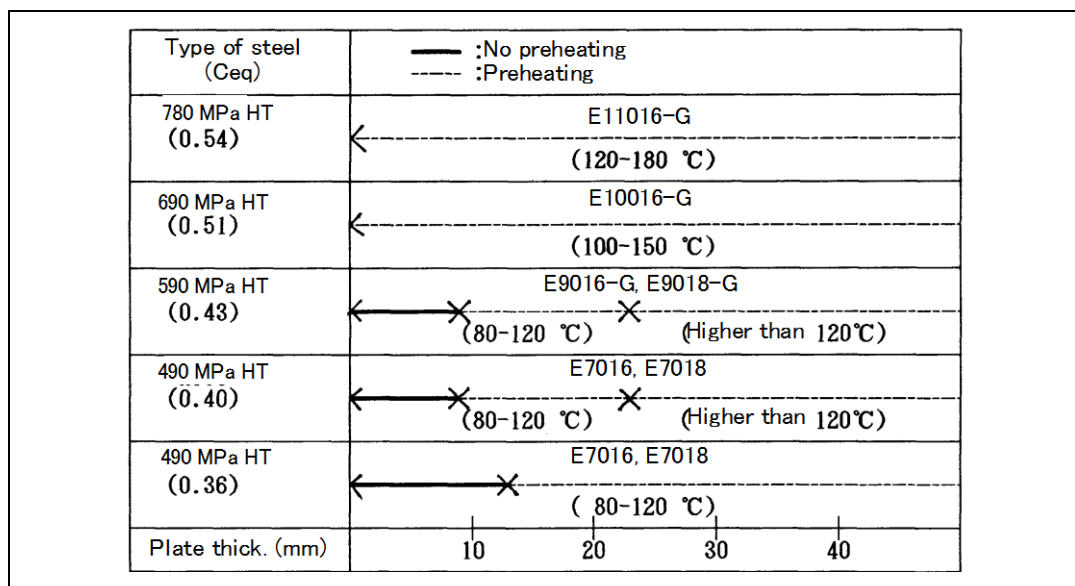

Fig. 3.1 — A guide to matching covered electrodes (AWS class.) and preheating temperatures for the all-position welding of high-strength steels as the functions of plate thickness and the carbon equivalent

Table 3.5 — Suitable covered electrodes for the all-position welding of dissimilar-strength steel joints

Combination of dissimilar-strength steels ⁽¹⁾		General choices for covered electrodes	
		JIS Z 3211:2008	AWS A5.1:2012, A5.5:2014
780HT	690HT	E6916-N3CM1	E10016-G
	590HT	E6216-N1M1, E6218-N1M1	E9016-G, E9018-G
	490HT	E4916, E4918	E7016, E7018
	Mild steel	E4316, E4916, E4918	E7016, E7018
690HT	590HT	E6216-N1M1, E6218-N1M1	E9016-G, E9018-G
	490HT	E4916, E4918	E7016, E7018
	Mild steel	E4316, E4916, E4918	E7016, E7018
590HT	490HT	E4916, E4918	E7016, E7018
	Mild steel	E4316, E4916, E4918	E7016, E7018
490HT	Mild steel	E4316, E4916, E4918	E7016, E7018

Note: (1) Classified by tensile strength (MPa).

3.1.3 Essential factors for quality control in welding

(a) Redrying of covered electrodes

The main sources of diffusible hydrogen in a weld metal are the moisture contained in the covering flux in the as-produced condition, the moisture absorbed by the covering flux during exposure to the atmosphere, and the moisture in the welding atmosphere. As the amount of moisture increases, the amount of diffusible hydrogen in the weld metal increases. Diffusible hydrogen in a weld metal can cause welding defects such as cracks and blowholes. Covered electrodes should, therefore, be kept dry in storage and handling in order to minimize the moisture pickup. In particular, low-hydrogen covered electrodes must be redried before use in a redrying oven to reduce the moisture content of the coverings to the as-produced levels for recovering their inherent usability and weldability. The other types of covered electrodes should be redried when they picked up moisture so much that the usability of the electrode is degraded causing much spatter, undercut, and blowholes.

Proper redrying conditions for high-strength steel covered electrodes are shown in **Table 3.6**. It is recommended to redry ordinary low-hydrogen electrodes for 490-MPa high-tensile strength steel at 300-350°C for 0.5-1 hour, while extra-low-hydrogen and ultra-low-hydrogen electrodes are required to redry at 350-400°C for one hour. It should be noted, however, that redrying conditions depend on individual brand of covered electrode. Redrying should, therefore, be conducted according to the manufacturer's specification of the electrode to be used. The absorbed moisture cannot sufficiently be removed, if the redrying temperature is not proper and the redrying time is not sufficient. The redried low-hydrogen electrodes should be stored in a storage oven kept at the storage temperature shown in Table 3.6 in order to prevent moisture pickup until they are used.

Table 3.6 — Recommended redrying and storage conditions for low-hydrogen covered electrodes for high-strength steels

Type of electrode (AWS)	Temperature for redrying (°C)	Time for redrying (min)	Storage temperature after redrying (°C)
E7016 E7018 E7048	300-350 or 350-400 ⁽¹⁾	30-60 or 60 ⁽¹⁾	100-150
E9016-G E9018-G E10016-G E11016-G	350-400	60	100-150

Note:

(1) For the proper redrying temperature and time for a particular brand of electrode, the manufacturer should be consulted.

(b) Preheating

By preheating a weld, its cooling rate during welding can be decreased; consequently, the weld becomes less in hardenability, removal of dissolved hydrogen from the weld is accelerated, and thereby weld cracking can be prevented. Preheating temperature should generally be higher as the amounts of alloying elements and diffusible hydrogen in the weld increase and the plate thickness increases, as already mentioned in Section 2.2.2. The preheating temperatures used in practical applications are shown in **Table 3.7**.

Table 3.7 — Specified minimum preheating and interpass temperatures (°C) for Hanshin Highway Bridge Construction in Japan⁽¹⁾

Type of welding	Welding process	SMAW	SMAW	GMAW SAW	SMAW	GMAW SAW	SMAW	GMAW	SAW	
	Kind of steel	SM400 SS400	SM490		SM570		HT70, HT80 ⁽²⁾			
	Joint Plate thick.(mm)	Fillet, Corner	Butt, Fillet, Corner		Butt, Fillet, Corner		Butt, Fillet, Corner		Butt	Fillet
Main welding	t ≤ 25	—	—	—	40	—	—	—	—	—
	25 < t ≤ 38	40	40	—	80	40	100	80	100	80
	38 < t ≤ 50	—	80	Corner joint: 40	80	60	100	80	100	80
	50 < t	—	100	80	100	80	120	100	150	100
Tack welding	t ≤ 25	—	—	—	60	—	—	—	X	
	25 < t ≤ 38	—	60	—	100	CO ₂ : 80	120	CO ₂ : 100		
	38 < t ≤ 50	60	100	CO ₂ : 60	100	CO ₂ : 80	120	CO ₂ : 100		
	50 < t	—	—	—	120	CO ₂ : 100	150	CO ₂ : 100		

Note:

- (1) Minimum preheat and interpass temperatures shall be ensured for the distance of 50-100mm on both sides of the weld along the welding line, by measuring the temperature with a surface thermometer or crayon.
- (2) Maximum preheating and interpass temperatures for HT70 and HT80 shall be 200°C or lower for t ≤ 50 and 230°C or lower for t > 50. HT70 and HT80 are equivalent to 690- and 780-MPa HT, respectively.

(c) Welding conditions and mechanical properties

The mechanical properties of weld metal can be affected by the welding parameters (welding current, arc voltage, and welding speed), plate thickness, and preheating and interpass temperatures. The relationship between heat input and the mechanical properties of weld metals are shown in **Fig. 3.2**, which are the test results of weld metals of 780-MPa (80-kgf/mm²) high-tensile strength steel. Heat input is the energy supplied by the welding arc to the workpiece, which can be calculated as follows: $HI = [(A \times V) / R] \times 60$ where HI is heat input (Joule/cm); “A” is welding current (Amp); “V” is arc voltage (Volt); “R” is carriage speed (cm/min). The figures clearly show that tensile strength and notch toughness decrease as the heat input increases. This is because the use of high heat input causes coarse crystal grain structures of the weld metal.

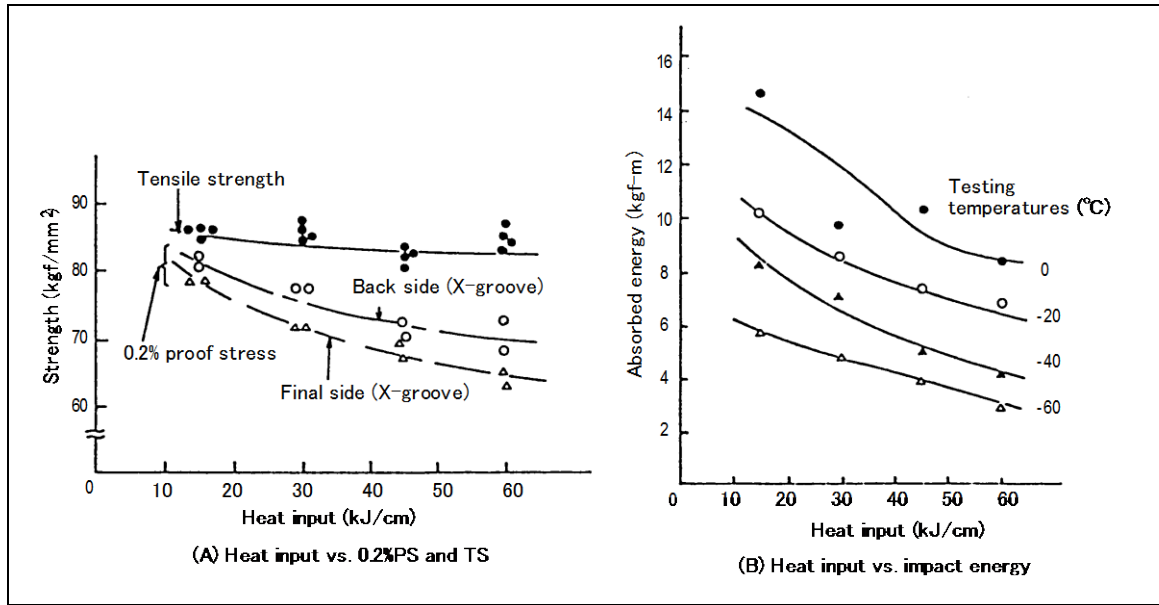

Fig. 3.2 — Relationship between heat input and mechanical properties of 780-MPa (80 kgf/mm²) high-tensile strength weld metals by SMAW (1 kgf/mm² = 9.8 MPa; 1 kgf-m = 9.8J)

(d) PWHT and mechanical properties

Postweld heat treatment (PWHT) is used to remove the residual stresses induced by welding. As a result of relieving the residual stresses, PWHT generally decrease the tensile strength of the weld. It also affects the notch toughness of the weld depending on the chemical composition of the weld. The notch toughness of 490-MPa high-tensile strength steel welds can be improved by PWHT. However, the notch toughness of 590-MPa and higher strength steel welds is generally decreased by PWHT, because of the stress relief (SR) embrittlement. Fig. 3.3 shows the effect of PWHT on the tensile strength of weld metals with three different tensile strength levels. It clearly shows that as the temper parameter, $P = T(20 + \log t)$, increases the tensile strengths gradually decrease. The temperature and soaking time of PWHT must, therefore, be thoroughly examined beforehand in order to satisfy the required mechanical properties after PWHT.

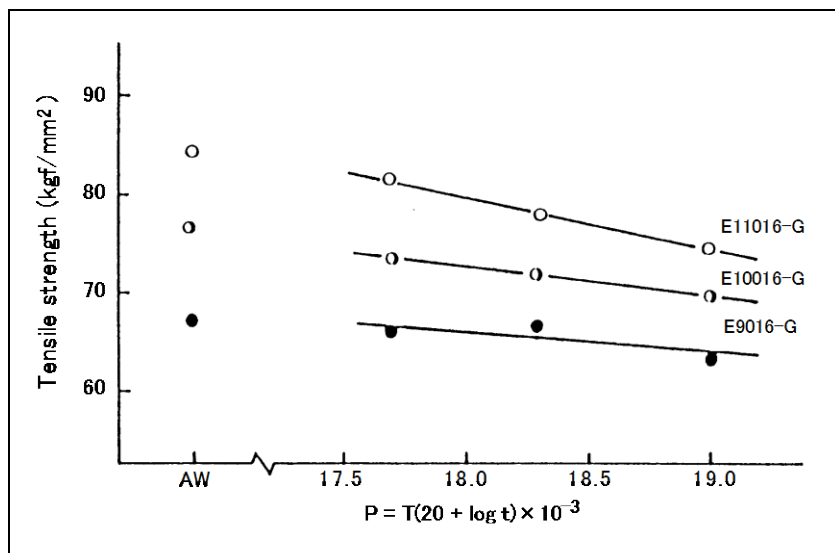

Fig. 3.3 — Effect of PWHT on the tensile strength of high-strength steel weld metals, where
 P: Temper parameter
 T: PWHT temperature (K)
 t: PWHT time (h)
 (1 kgf/mm² = 9.8 MPa)

3.2 Submerged arc welding

3.2.1 Types and features of welding wires and fluxes

Submerged arc welding uses wires and fluxes. The use of high currents in submerged arc welding offers deeper weld penetration; consequently, the chemical composition of the weld metal is greatly affected by the chemical composition of the base metal due to greater dilution caused by the admixture of the base metal. A suitable combination of wire and flux should therefore be correctly determined after testing their performance with the base metal to be used. Standards for submerged arc welding consumables specify both wires and fluxes. For example, AWS A5.17:97(R2007) (Carbon Steel Electrodes and Fluxes for Submerged Arc Welding) includes classifications and requirements for submerged arc welding wires and fluxes for 490-MPa high-tensile strength steel, as shown in **Table 3.8**.

Table 3.8 — Classifications and requirements for submerged arc welding solid wires and fluxes for 490-MPa high-tensile strength steel [Excerpted from AWS A 5.17:97(R2007)]

Classification ⁽¹⁾		Chemical composition of wire (%)						
		C	Mn	Si	S	P	Cu	Others
Wire	EL8	0.10 max	0.25-0.60	0.07 max	0.030 max	0.030 max	0.35 max	0.50 max
	EL12	0.04-0.14	0.25-0.60	0.10 max				
	EM12K	0.05-0.15	0.80-1.25	0.10-0.35				
	EH14	0.10-0.20	1.70-2.20	0.10 max				

Classification ⁽²⁾		Mechanical properties of weld metal			
		Tensile strength (ksi)	0.2% proof strength (ksi)	Elongation (%)	Charpy impact energy, average (ft-lbf)
Flux	F7A0-EXXX	70-95	58 min	22 min	20 min at 0°F
	F7A2-EXXX				20 min at -20°F
	F7A4-EXXX				20 min at -40°F
	F7P4-EXXX				20 min at -40°F

Note: (1) Classification system of EXXX

- E: designates an electrode.
- L: indicates low manganese content.
- M: indicates medium manganese content.
- H: indicates high manganese content.
- 8: indicates the nominal carbon content: 0.08.
- 12: indicates the nominal carbon content: 0.12.
- 14: indicates the nominal carbon content: 0.14.
- K: indicates that the electrode is made from a heat of silicon-killed steel.

(2) Classification system of FXXX-EXXX

- F: designates a virgin flux.
- 7: represents the minimum tensile strength of the weld metal in 70 ksi.
- A: indicates that the weld metal was tested in the as-welded condition.
- P: indicates that the weld metal was tested after postweld heat treatment.
- 0: designates 0 degree F as the temperature at which the weld metal meets the required 20 ft-lbf Charpy V-notch impact strength.
- 2: designates -20 degrees F as the temperature at which the weld metal meets the required 20 ft-lbf Charpy V-notch impact strength.
- 4: designates -40 degrees F as the temperature at which the weld metal meets the required 20 ft-lbf Charpy V-notch impact strength.
- EXXX: refers to the electrode classification with which the flux will deposit the weld metal that meets the specified mechanical properties when tested as called for in the specification.

In addition, AWS A5.23:2011 (Low Alloy Steel Electrodes and Fluxes for Submerged Arc Welding) specifies wires and fluxes for high-strength steel with higher strength than that specified in AWS A5.17, as shown in **Table 3.9**.

Table 3.9 — Classifications and requirements for submerged arc welding wires and fluxes for high-strength steel (Excerpted from AWS A5.23:2011)

Classification		Chemical composition (%)							
		C	Mn	Si	S	P	Mo	Cu	Others ⁽¹⁾
Wire	EA3	0.05-0.17	1.65-2.20	0.20 max	0.025 max	0.025 max	0.45-0.65	0.35 max	—
	EA4	0.05-0.15	1.20-1.70						
	EG	Not specified							
Weld metal	A3	0.15 max	2.10 max	0.80 max	0.030 max	0.030 max	0.40-0.65	0.35 max	—
	A4	0.15 max	1.60 max						
	G	As agreed between supplier and purchaser.							

(1) Analysis for B is required if intentionally added, or if it is known to be present at levels greater than 0.0010%.

Classification		Tensile properties of weld metal		
		Tensile strength (ksi)	0.2% proof strength (ksi)	Elongation (%)
Flux	F8XX-EXX-X	80-100	68 min	20 min
	F9XX-EXX-X	90-110	78 min	17 min
	F10XX-EXX-X	100-120	88 min	16 min
	F11XX-EXX-X	110-130	98 min	15 min
	F12XX-EXX-X	120-140	108 min	14 min

Impact properties of weld metal	
Digit	Charpy impact energy, average (ft-lbf)
Z	Not specified
0	20 min at 0°F
2	20 min at -20°F
4	20 min at -40°F
6	20 min at -60°F
8	20 min at -80°F
10	20 min at -100°F

Examples of designations: **F9A6-EA3-A3**, **F8P6-EA3-A3**
 F: designates a flux.
 9, 8: represents the minimum tensile strengths of the weld metal.
 A, P: indicates that the weld metal was tested and classified in the as-welded condition (A) or in the postweld heat-treated condition (P).
 6: designates -60°F as the temperature at which the weld metal meets the required 20ft-lbf Charpy impact energy.
 EA3: designates a solid wire having the chemical composition specified as to EA3.
 A3: indicates the chemical composition of the weld metal specified as to A3.

3.2.2 Selection of welding wires and fluxes

In general the way of selecting suitable welding consumables for submerged arc welding of high-strength steel is similar to that of selecting suitable covered electrodes discussed in Section 3.1.2. In the case of submerged arc welding, however, a suitable combination of wire and flux must be selected taking into account the proper chemical composition and mechanical properties of the expected weld metal, referring to the relevant standard. In selecting a flux, the type of flux must be considered; fused type and bonded type are available for welding high-strength steels. Both of these fluxes have advantages and disadvantages in terms of the weldability and usability. Fused fluxes pick up little moisture; on the other hand, they allow the weld metal to contain a higher amount of hydrogen. In contrast, bonded fluxes tend to pick up moisture much more; however, they can provide weld metals with lower hydrogen content. Fused fluxes offer deeper weld penetration. Bonded fluxes offer lower flux consumption ratios. The most appropriate flux should be selected considering these advantages and disadvantages.

3.2.3 Essential factors for quality control in welding

(a) Redrying of fluxes

Fused fluxes, which consist of fine glassy particles, absorb little moisture in the atmosphere. The amount of absorbed moisture in a fused flux may be as low as about 0.01% after being exposed to the atmosphere of 30°C x 80%RH for 24 hours. However, the adsorbed moisture on the particles of a fused flux may cause blowholes and cold cracking in the weld. Fused fluxes should therefore be redried at 150-350°C for one hour before use. Bonded fluxes, which consist of pelletized mineral particles, tend to absorb moisture much more when compared with fused fluxes. So, they should be handled more carefully than for the fused fluxes from the viewpoint of moisture absorption. Bonded fluxes should therefore be redried at 200-300°C for one hour before use.

(b) Preheating

The effect of preheating a base metal in submerged arc welding is basically the same as that in shielded metal arc welding discussed in Section 3.1.3 (b). In the case of submerged arc welding, however, the use of higher welding currents or higher heat input affects the preheating temperature to be needed. As shown in **Fig. 3.4**, the use of higher heat input is advantageous to prevent cold cracking, because higher heat input results in lower cooling rates of the weld. **Fig. 3.4** obviously shows that the preheating temperature can be decreased in terms of preventing cold cracking, when the heat input is high. This is why, a lower preheating temperature may be used in submerged arc welding than in shielded metal arc welding. However, heat input should be controlled to a proper extent suitable for the welding procedure, because high heat input tends to cause hot cracking in weld metals.

(c) Welding conditions and mechanical properties

The mechanical properties of weld metals made by submerged arc welding can vary depending on heat input — i.e. on the welding current, arc voltage, and welding speed. The effect of heat input on the mechanical properties is similar to that shown in **Fig. 3.2** in Section 3.1.3. Heat input should therefore be controlled in order to attain satisfactory mechanical properties, because tensile strength and notch toughness decrease with excessive heat input. In addition, submerged arc welding brings about deeper weld penetration than does shielded metal arc welding. Deeper weld penetration causes greater weld metal dilution due to the admixture of the base metal to a larger extent. Greater weld metal dilution affects the chemical composition and thus the mechanical properties of the weld metal.

(d) Flux-burden height

Flux-burden height is the height of the layer of granular flux supplied in the vicinity of the arc, which influences the appearance and soundness of the finished weld as well as the welding performance in submerged arc welding. Where it is too low, it causes the arc flashing, blowholes, and irregular weld bead appearance. Where it is too high, it causes an unstable arc and irregular weld bead appearance. An optimum flux-burden height can vary depending on the welding conditions. It is a skill of welding operators to adjust the flux-burden height most properly according to a particular welding condition.

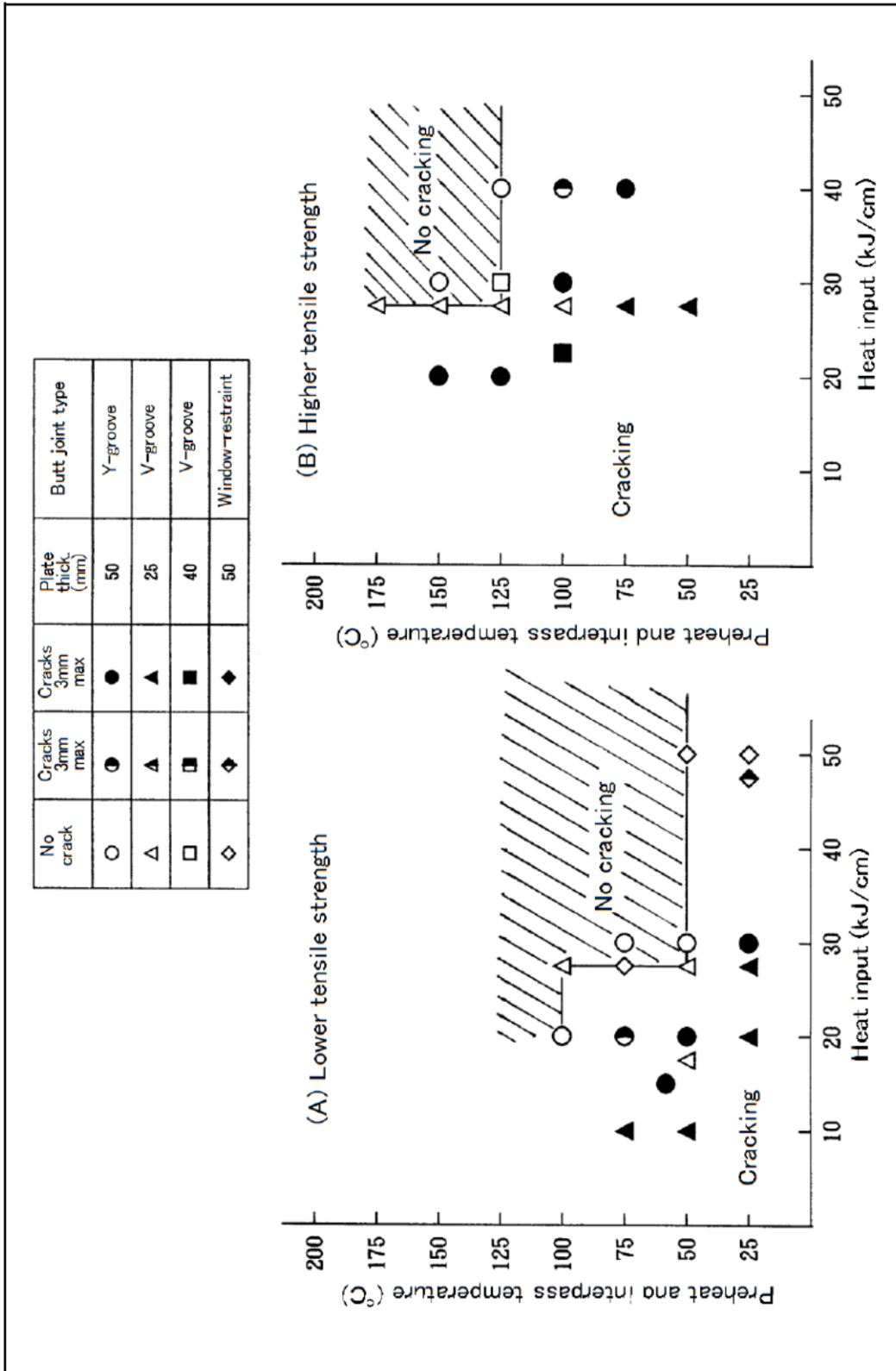

Fig. 3.4 — Results of the cold cracking tests of 780-MPa HT welds (AWS F11A6-EG-G) in multi-layer submerged arc welding

3.3 Gas shielded metal arc welding

3.3.1 Types and features of welding wires

In gas shielded metal arc welding, solid wires and flux-cored wires are used. **Table 3.10** includes solid wires for 490-MPa high-tensile strength steel, which are excerpted from AWS A5.18:2005 (Carbon Steel Electrodes and Rods for Gas Shielded Arc Welding), and flux-cored wires for 490-MPa high-tensile strength steel, which are excerpted from AWS A5.20:2005 (Carbon Steel Electrodes for Flux Cored Arc Welding). As to solid wires for high-strength steel having higher tensile strengths, refer to AWS A5.28:2005 (Low Alloy Steel Electrodes and Rods for Gas Shielded Arc Welding). As to flux-cored wires for high-strength steel having higher tensile strengths, refer to AWS A5.29:2010 (Low-Alloy Steel Electrodes for Flux Cored Arc Welding). In gas shielded metal arc welding of high-strength steels, CO₂ and Ar+CO₂ mixtures are commonly used for the shielding gas.

3.3.2 Selection of welding wires and shielding gases

Table 3.11 is a guide to proper wires for welding high-strength steels. A solid wire of JIS YGW11 type is suitable for flat and horizontal fillet welding with higher welding currents, while a wire of JIS YGW12 type is suitable for all position welding with lower welding currents. In cases where less spattering, larger deposition rates and better weld bead appearance are more important, flux-cored wires are more suitable than solid wires.

CO₂ shielding is most widely used for welding high-strength steels in Japan because of its lower cost. However, an Ar+CO₂ mixture is superior to CO₂ in terms of the usability and mechanical properties of the weld metal. Individual wires for gas shielded metal arc welding use the specific shielding gas or gases for good performance and for satisfying the requirements of mechanical properties; therefore, an appropriate combination of a wire and a shielding gas should be selected.

3.3.3 Essential factors for quality control in welding

For conducting successful gas shielded metal arc welding, the following matters should be noted, besides the general notes common to every welding process. For details, refer to the textbook “Essential Factors in Gas Shielded Metal Arc Welding,” which is issued separately.

- a) The purity of CO₂ gas must be 99.8 vol% min.
- b) The purity of Ar gas must be 99.99 vol% min.
- c) The flow rate of a shielding gas should be 20-25 l/min.
- d) A wind screen should be used to keep the gas shielding stable where wind velocity is more than 2 m/sec.
- e) The distance between the contact tip and the base metal or wire extension should be 10-15 mm where welding current is 200A or lower, 15-20 mm for 200-350A, and 20-25 mm for 350A or higher.

Table 3.10 — Classifications and requirements for solid wires and flux-cored wires for gas metal arc welding (Excerpted from AWS A5.18:2005 and A5.20:2005)

Classification (1)	Chemical composition of solid wire and weld metal of flux-cored wire (%)													Shielding gas	Type of current	
	C	Mn	Si	P	S	Cu	Ti	Zr	Al	Cr	Ni	Mo	V			
Solid wire (A5.18)	ER70S-2	0.07 max.	0.90-1.40	0.40-0.70	0.025 max	0.035 max	0.50 max	0.05-0.15	0.02-0.12	0.05-0.15	0.15 max.	0.15 max.	0.03 max.	CO ₂	DC-EP	
	ER70S-3	0.06-0.15	0.90-1.40	0.45-0.75				—	—	—						
	ER70S-6	0.06-0.15	1.40-1.85	0.80-1.15				—	—	—						
ER70S-G	(2)													(2)	(2)	
Flux cored wire (A5.20)	E70T-1C	0.12 max	1.75 max	0.90 max	0.03 max	0.35 max	—	—	—	—	0.20 max	0.50 max	0.30 max	0.08 max	CO ₂ Ar+CO ₂ ⁽³⁾ CO ₂ Ar+CO ₂ ⁽³⁾	DC-EP
	E70T-1M															
	E71T-1C															
	E71T-1M															

Classification	Mechanical properties of weld metal			
	Tensile strength (ksi)	Yield strength at 0.2% offset (ksi)	Elongation (%)	Charpy impact value, average (ft-lbf)
Solid wire (A5.18)	70 min	58 min	22 min	20 min at -20°F
				20 min at 0°F
				20 min at -20°F
				(2)
Flux cored wire (A5.20)	70-95	58 min	22 min	20 min at 0°F

Note: (1) Classification system of A5.18 ERXXS-X:
 E: Designates an electrode.
 R: Designates a rod.
 70: Indicates the minimum tensile strength in ksi.
 S: Designates a solid wire.
 The last digit: Indicates the chemical composition of a solid wire, whereas "G" stands for "general" classification.

Classification system of A5.20 EXXT-XX:

- E: Designates an electrode.
- 7: Indicates the minimum tensile strength in 10 ksi.
- The third digit indicates intended welding position: 0 is for flat and horizontal position only, 1 is for all positions.
- T: Designates a flux-cored wire.
- 1: Refers to usability of the wire.
- C: Indicates that the wire is classified as using CO₂. M: Indicates that the wire is classified as using 75-80%Ar/balanced CO₂.

Table 3.11 — A guide for selection of gas shielded metal arc welding wires for high-strength steels

Type of steel ⁽¹⁾	Trade desig. ⁽²⁾	JIS classification ⁽³⁾	AWS classification ⁽³⁾	Typical shielding gas	Welding position ⁽⁴⁾
490HT	MG-50	Z3312 YGW11	A5.18 ER70S-G	CO ₂	F, H, HF
	MG-51T	Z3312 YGW12	A5.18 ER70S-6	CO ₂	All positions
	MG-S50	Z3312 G49AP3M 16	A5.18 ER70S-G	80%Ar+20%CO ₂	All positions
	DW-100	Z3313 T49J0T1-1CA-U	A5.20 E71T-1C	CO ₂	All positions
	MX-100	Z3313 T49J0T15-0CA-U	A5.20 E70T-1C	CO ₂	F, H, HF
590HT	MG-60	Z3312 G59JA1UC 3M1T	A5.28 ER80S-G	CO ₂	All positions
	MG-S63B	Z3312 G59JA1UMC1M1T	A5.28 ER90S-G	80%Ar+20%CO ₂	All positions
690HT	MG-S70	Z3312 G69A2UM N4CM21T	A5.28 ER100S-G	80%Ar+20%CO ₂	All positions
780HT	MG-S80	Z3312 G78A4M N5CM3T	A5.28 ER110S-G	80%Ar+20%CO ₂	All positions

Note: (1) Classified by tensile strength (MPa)

(2) Trade designations of wires produced by Kobe Steel

(3) As per JIS Z3312:2009, Z3313:2009, AWS A5.18:2005, A5.20:2005, and A5.28:2005

(4) F: flat, H: horizontal, HF: horizontal fillet

3.4 Gas tungsten arc welding

Gas tungsten arc welding is for thin pipes and the root pass of medium and thick pipes in general. It is also used for fabricating penstocks and pressure vessels by using automatic welding processes that provide larger deposition rates.

3.4.1 Types and features of welding wires

Table 3.10 also includes solid wires for gas tungsten arc welding of 490-MPa high-tensile strength steel. As to other solid wires for gas tungsten arc welding of high-strength steel having higher tensile strength, refer to AWS A5.28:2005 (Low-Alloy Steel Electrodes and Rods for Gas Shielded Arc Welding).

3.4.2 Selection of welding wires

The selection of a proper wire depends on the requirements of tensile strength and chemical composition of the weld metal. The chemical composition of the weld metal is almost the same as that of the wire because an inert gas such as Ar is commonly used for shielding, and the weld metal dilution caused by the admixture of the base metal is low.

3.4.3 Tips for better welding results

The proper gas shielding flow rate is usually 10-15 l/min, although it depends on the welding current and the type of welding joint in gas tungsten arc welding. Wind can readily influence the soundness of a weld in gas tungsten arc welding; therefore, the arc area should be screened to keep the gas shielding stable where wind velocity is 1 m/sec or higher. In addition, the fusion surface of the welding joint must be clean without rust, oil, grease, paint, and other dirt.

Arc Welding of Heat-Resistant Low-Alloy Steel

Contents

1. Types and features of heat-resistant low-alloy steels	2-2
2. Welding metallurgy and weldability	2-7
2.1 Hardenability of welds	2-7
2.2 Cold cracking	2-9
2.3 Hot cracking	2-11
2.4 SR cracking	2-13
2.5 Effects of postweld heat treatment	2-14
2.6 Temper embrittlement	2-18
2.7 Dissimilar-metal joints	2-19
3. Welding processes and welding consumables	2-21
3.1 Welding processes and applications	2-21
3.2 Types and features of welding consumables	2-22
3.3 Selection guide for proper welding consumables	2-29
4. Essential factors for quality control in welding	2-30
4.1 Preparation of welding grooves	2-30
4.2 Redrying of welding consumables	2-32
4.3 Gas shielding	2-32
4.4 Flux-burden height	2-32
4.5 Preheat and interpass temperatures	2-33
4.6 Postweld heat treatment	2-33

1. Types and features of heat-resistant low-alloy steels

Heat-resistant low-alloy steels are used for the equipment of fossil power plants, oil refineries, chemical plants and nuclear power plants due to the excellent resistibility to high temperatures and corrosion. **Table 1.1** shows the chemical compositions of popular heat-resistant low-alloy steels specified by the ASTM standard. Most heat-resistant low-alloy steels contain chromium to provide better resistibility against oxidation at elevated temperatures and molybdenum to provide better resistibility against creep. Some heat-resistant low-alloy steels contain nickel to provide better notch toughness. **Fig. 1.1** shows typical applications for heat-resistant low-alloy steels as a function of service temperature, in which higher-temperature services need higher-alloy steels, and the exact applicable temperature range depends on the other service conditions including corrosive factors, in addition to the service temperature.

Table 1.1 — Specified chemical composition of popular types of heat-resistant low-alloy steels ⁽¹⁾

Type of steel	ASTM Standard		C	Si	Mn	P	S	Cr	Mo	Ni	V
	Plate	Forging									
0.5Mo	A204Gr.A	—	0.25	0.15-0.40	0.90	0.035	0.035	—	0.45-0.60	—	—
	A204Gr.B	—	0.27	0.15-0.40	0.90	0.035	0.035	—	0.45-0.60	—	—
	A204Gr.C	—	0.28	0.15-0.40	0.90	0.035	0.035	—	0.45-0.60	—	—
	—	A182F1	0.28	0.15-0.35	0.60-0.90	0.045	0.045	—	0.44-0.65	—	—
0.5Cr-0.5Mo	A387Gr.2	—	0.05-0.21	0.15-0.40	0.55-0.80	0.035	0.035	0.50-0.80	0.45-0.60	—	—
	—	A182F2	0.05-0.21	0.10-0.60	0.30-0.80	0.040	0.040	0.50-0.81	0.44-0.65	—	—
1.25Cr-0.5Mo	A387Gr.11	—	0.05-0.17	0.50-0.80	0.40-0.65	0.035	0.035	1.00-1.50	0.45-0.65	—	—
	—	A182F11 Cl.1	0.05-0.15	0.50-1.00	0.30-0.60	0.030	0.030	1.00-1.50	0.44-0.65	—	—
2.25Cr-1Mo	A387Gr.22	—	0.05-0.15	0.50	0.30-0.60	0.035	0.035	2.00-2.50	0.90-1.10	—	—
	—	A182F22 Cl.1	0.05-0.15	0.50	0.30-0.60	0.040	0.040	2.00-2.50	0.87-1.13	—	—
3Cr-1Mo	A387Gr.21	—	0.05-0.15	0.50	0.30-0.60	0.035	0.035	2.75-3.25	0.90-1.10	—	—
	—	A182F21	0.05-0.15	0.50	0.30-0.60	0.040	0.040	2.7-3.3	0.80-1.06	—	—
5Cr-1Mo	A387Gr.5	—	0.15	0.50	0.30-0.60	0.035	0.030	4.00-6.00	0.45-0.65	—	—
	—	A182F5	0.15	0.50	0.30-0.60	0.030	0.030	4.0-6.0	0.44-0.65	0.50	—
9Cr-1Mo	A387Gr.9	—	0.15	1.00	0.30-0.60	0.030	0.030	8.00-10.00	0.90-1.10	—	—
	—	A182F9	0.15	0.50-1.00	0.30-0.60	0.030	0.030	8.00-10.00	0.90-1.10	—	—
Mn-Mo, Mn-Mo-Ni	A302 Gr.B	—	0.25	0.15-0.40	1.15-1.50	0.035	0.035	—	0.45-0.60	—	—
	A533 Type B	—	0.25	0.15-0.40	1.15-1.50	0.035	0.035	—	0.45-0.60	0.40-0.70	—
	—	A508Cl.3	0.25	0.40	1.20-1.50	0.025	0.025	0.25	0.45-0.60	0.40-1.00	0.05

Note: (1) Excerpted from 2009 Annual books of ASTM standards except for A508Gr.3 that is from a separate specification of ASTM A508/A508M-14; Single values are maximum amounts in wt%.

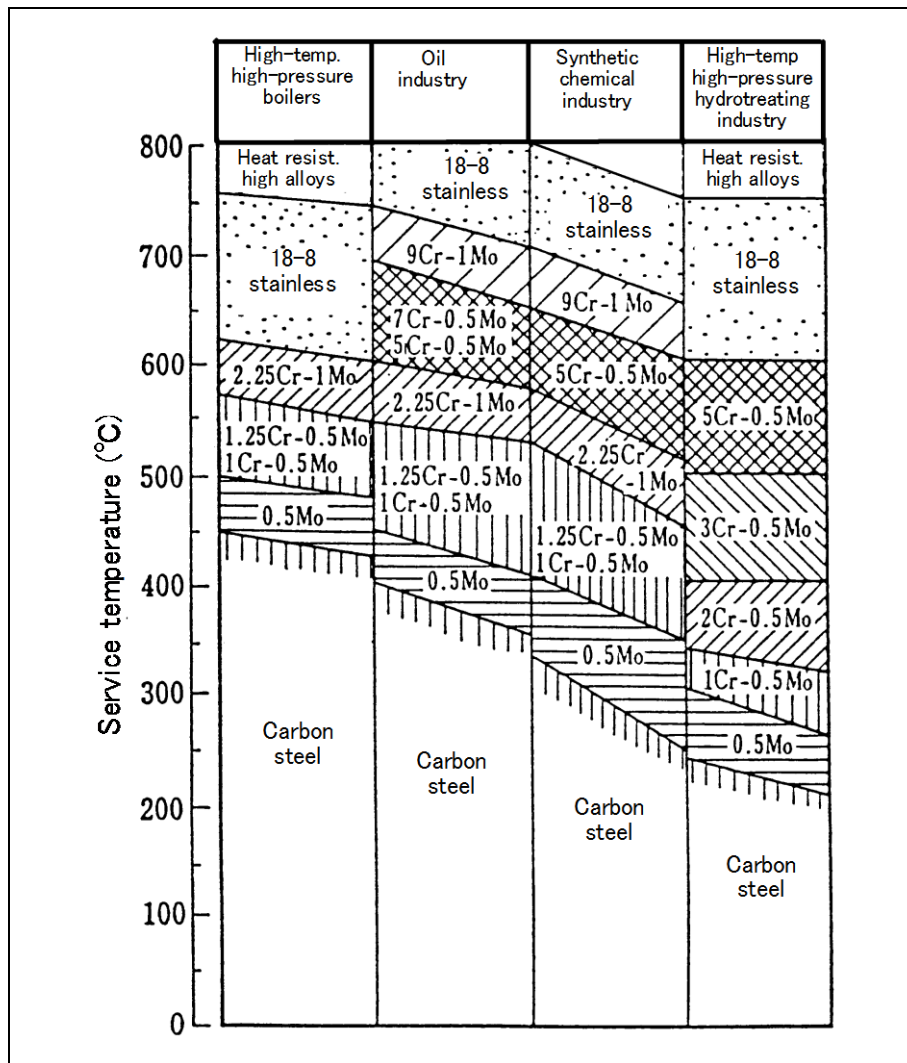

Fig. 1.1 — Various steels and alloys and their applications as a function of service temperature

At normal atmospheric temperatures, gaseous molecular hydrogen does not readily permeate steel, even at high pressures. At elevated temperatures, however, molecular hydrogen dissociates into the atomic form, which can readily enter and diffuse through the steel. Under this condition, the diffusion of hydrogen in the steel is more rapid. The diffused hydrogen in the steel may react with the carbon in the steel to cause either surface decarburization or internal decarburization and fissuring. This form of hydrogen damage is referred to as the high-temperature hydrogen attack.

Desulfurization reactors, for example, are subject to pressurized hydrogen in operation at high temperatures. The hydrogen partial pressure and service temperature are the factors which determine the suitable type of low-alloy steel, as shown in **Fig. 1.2**. This figure, known as “Nelson Curve,” suggests the limits of application of each type of steel for high-temperature, high-pressure services. Temperatures and pressures above the limiting curve for the individual steel can cause the hydrogen attack. The Nelson Curve clearly shows that higher temperature and pressure require higher-alloyed steel in order to resist the hydrogen attack. For the latest information, refer to API Recommended Practice 941-2008.

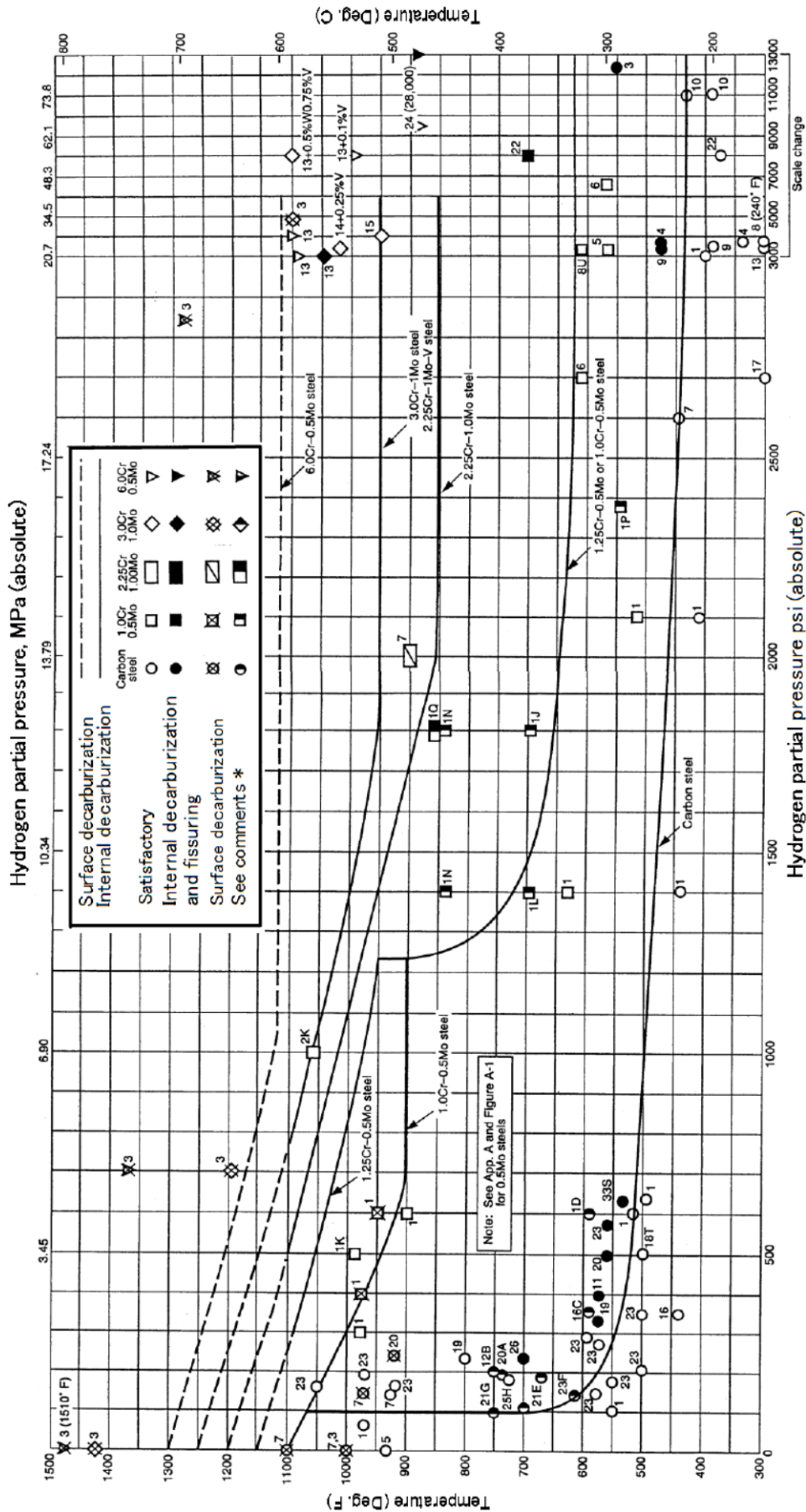

Fig. 1.2 — Operating limits for steels in hydrogen service to avoid decarburization and fissioning (Source: API Recommended Practice 941-1998 — Steels for Hydrogen Service at Elevated Temperatures and Pressures in Petroleum Refineries and Petrochemical Plants)

In addition to the conventional steels discussed above, Enhanced 2.25Cr-1Mo, 2.25Cr-1Mo-0.25V, and 3Cr-1Mo-0.25V-Ti-B steels have been developed. These advanced steels have higher strength than those of the conventional steels, as shown in **Table 1.2**. The higher strength is derived from lower tempering temperatures for Enhanced 2.25Cr-1Mo steel and small amounts of additional alloying elements for the other two types. The higher strength facilitates the use of higher allowable stresses over a range of metal temperatures, as shown in **Fig. 1.3**, as compared with conventional 2.25Cr-1Mo steel. These advanced steels, therefore, can be used in higher temperature services and facilitate the use of decreased steel thickness for stress-sustaining components. The typical applications are pressure vessels subjected to hydrogen service at elevated temperatures and high pressures in petroleum refineries and petrochemical plants. Nowadays, 2.25Cr-1Mo-0.25V steel is the main for such applications.

Table 1.2 — Chemical and mechanical requirements for advanced steels in comparison with conventional 2.25Cr-1Mo steel [Excerpted from ASTM A387/A387M-06a, A542/A542M-99(R2004)]

Chemical elements and mechanical properties	Conventional 2.25Cr-1Mo steel (A387 Gr.22)	Enhanced 2.25Cr-1Mo steel (A542 Type B Cl.4)	2.25Cr-1Mo-0.25V steel (A542 Type D Cl.4a)	3Cr-1Mo-0.25V-Ti-B steel (A542 Type C Cl.4a)
Carbon (%)	0.05-0.15	0.11-0.15	0.11-0.15	0.10-0.15
Manganese	0.30-0.60	0.30-0.60	0.30-0.60	0.30-0.60
Phosphorus	0.035 max	0.015 max	0.015 max	0.025 max
Sulfur	0.035 max	0.015 max	0.010 max	0.025 max
Silicon	0.50 max	0.50 max	0.10 max	0.13 max
Chromium	2.00-2.50	2.00-2.50	2.00-2.50	2.75-3.25
Molybdenum	0.90-1.10	0.90-1.10	0.90-1.10	0.90-1.10
Copper	—	0.25 max	0.20 max	0.25 max
Nickel	—	0.25 max	0.25 max	0.25 max
Vanadium	—	0.02 max	0.25-0.35	0.20-0.30
Titanium	—	—	0.030 max	0.015-0.035
Boron	—	—	0.0020 max	0.001-0.003
Columbium	—	—	0.07 max	—
Calcium	—	—	0.015 max	—
Tensile strength (ksi)	60-85	85-110	85-110	85-110
0.2% yield strength (ksi)	30 min	55 min	60 min	60 min
Elongation (%)	18 min	20 min	18 min	18 min

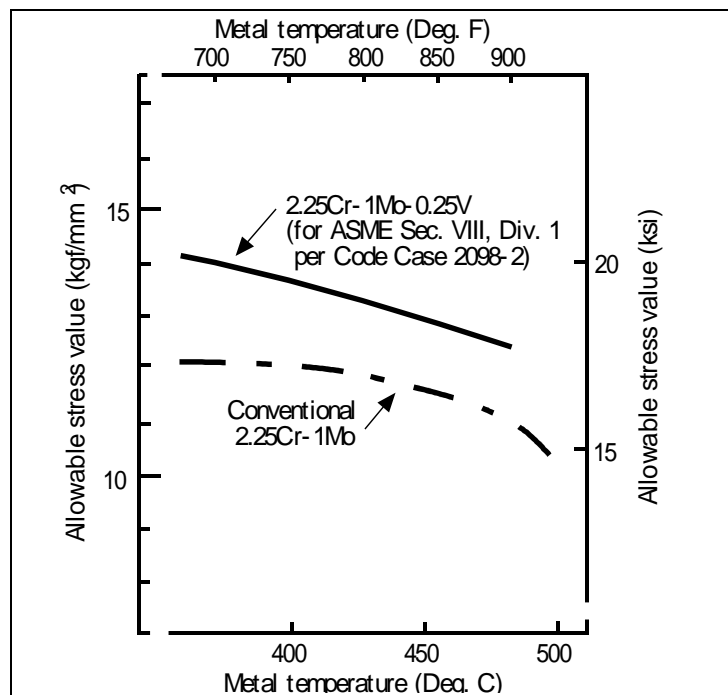

Fig. 1.3 — A comparison between advanced 2.25Cr-1Mo-V steel and conventional 2.25Cr-1Mo steel on maximum allowable stress as a function of metal temperature (1 kgf/mm² = 9.8 MPa; 1 ksi = 6.9 MPa)

9Cr-1Mo-V-Nb, Low C-2Cr-W-V-Nb and 12Cr-W-V-Nb are another group of advanced steels developed for power boilers, which provide higher strengths at high temperatures. These steels are used for ultra-super critical pressure boilers that are subject to higher-temperature higher-pressure steam for better power generation efficiency. Of these advanced steels, Modified 9Cr-1Mo is often used; **Table 1.3** shows its detailed chemical and mechanical properties. **Fig. 1.4** shows an advantage of 9Cr-1Mo-V-Nb steel on maximum allowable stress in comparison with conventional 2.25Cr-1Mo, 9Cr-1Mo, and Type 304 stainless steel at elevated temperatures. It clearly shows that 9Cr-1Mo-V-Nb can use higher allowable stresses at temperatures up to 600°C when compared with conventional steels. Header, super heater and reheater tubes of power boilers are typical applications for these advanced steels.

Table 1.3 — Chemical composition (%) and mechanical properties of 9Cr-1Mo-V-Nb steel

ASTM ⁽¹⁾	C	Mn	P	S	Si	Cr	Mo	Ni
A213Gr.T91(tube)	0.07-0.14	0.30-0.60	0.020 max	0.010 max	0.20-0.50	8.00-9.50	0.85-1.05	0.40 max
A335Gr.P91(pipe)	0.08-0.12	0.30-0.60	0.020 max	0.010 max	0.20-0.50	8.00-9.50	0.85-1.05	0.40 max
ASTM ⁽¹⁾	V	Cb	N	Al	UTS (ksi)	0.2%YS (ksi)	EI (%)	
A213Gr.T91(tube)	0.18-0.25	0.06-0.10	0.03-0.07	0.02 max	85 min	60 min	20 min	
A335Gr.P91(pipe)	0.18-0.25	0.06-0.10	0.03-0.07	0.02 max	85 min	60 min	20 min	

(1) Excerpted from ASTM A213/A213M-08 and A335/A335M-06. (Ti and Zr are also specified to be 0.01% max respectively for both materials)

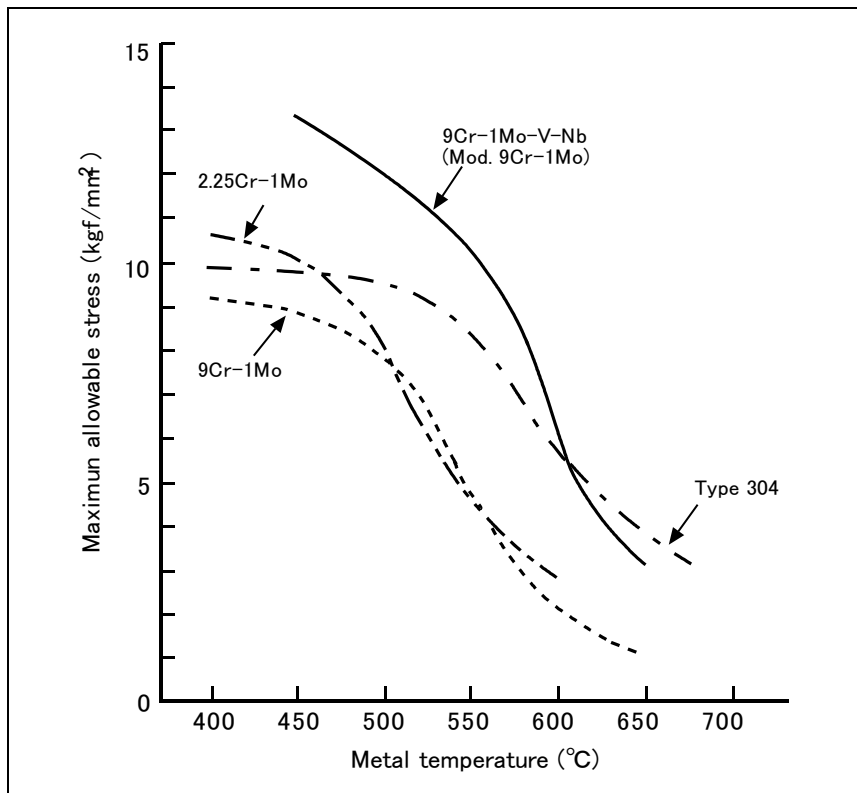

Fig. 1.4 — A comparison between Modified 9Cr-1Mo and other steels on maximum allowable stress over a range of metal temperatures (1 kgf/mm² = 9.8 MPa)

2. Welding metallurgy and weldability

Heat-resistant low-alloy steels are weldable but to a lesser degree than ordinary steels because of greater self-hardenability and crack susceptibility. The following sections discuss these problems and preventive measures.

2.1 Hardenability of welds

Alloying with chromium and molybdenum causes such greater hardenability that the steel can be hardened by cooling in still air from its austenitizing temperature. This hardenability is often called “self-hardenability.” The degree of self-hardenability of Cr-Mo steels can be estimated with the Time-Temperature-Transformation (TTT) Curves. **Fig. 2.1** shows a TTT curve for 2.25Cr-1Mo steel, while **Fig. 2.2** shows a TTT curve for 5Cr-0.5Mo steel. The two cooling curves shown with ① and ② in these figures refer to the lowest and the highest cooling rates in common arc welding. Fig. 2.1 clearly shows that the microstructure of 2.25Cr-1Mo steel is transformed from austenite to a mixture of martensite and bainite. As for 5Cr-0.5Mo steel, Fig. 2.2 clearly shows that the steel is transformed from austenite to martensite completely, which means 5Cr-0.5Mo steel has greater self-hardenability when compared with 2.25Cr-1Mo steel.

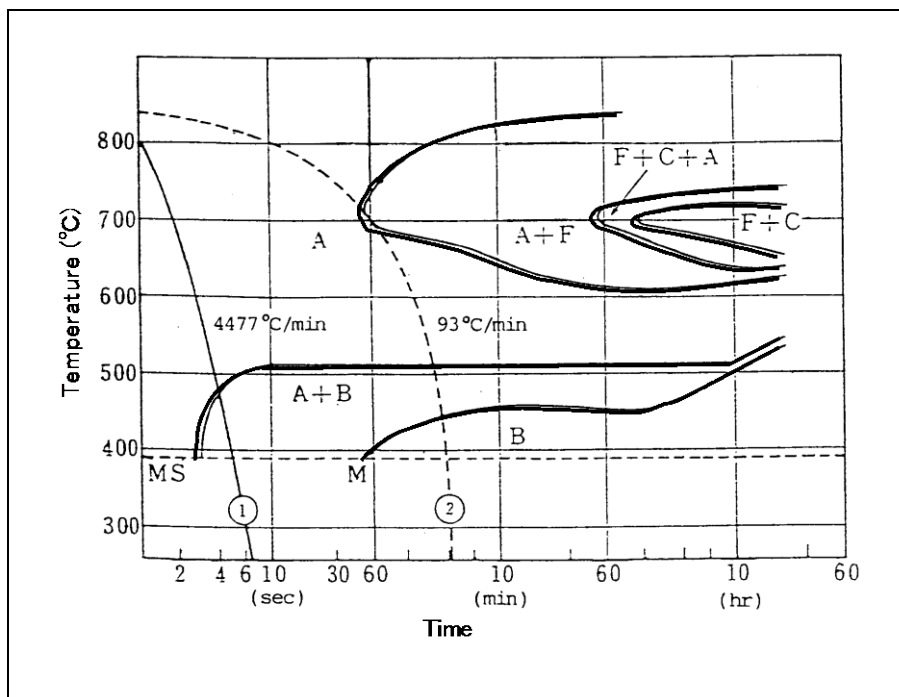

Fig. 2.1 — A Time-Temperature-Transformation (TTT) curve for 2.25Cr-1Mo steel

**A_{c3} : 871 °C, A_{r3} : 821 °C, A: Austenite, C: Cementite, M: Martensite
 A_{c1} : 804 °C, A_{r1} : 721 °C, B: Bainite, F: Ferrite**

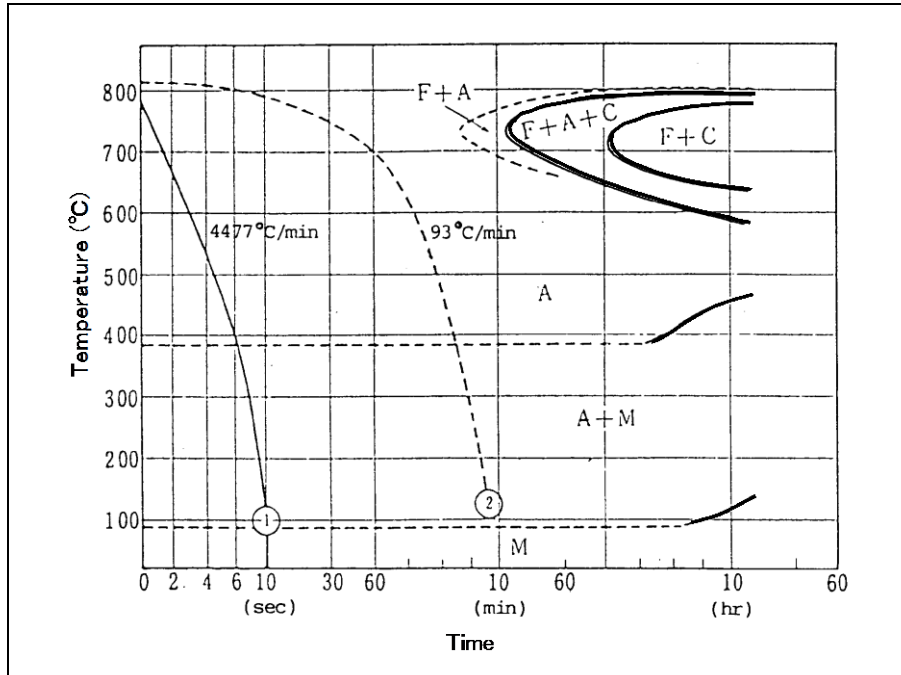

Fig. 2.2 — A Time-Temperature-Transformation (TTT) curve for 5Cr-0.5Mo steel

Fig. 2.3 shows the hardenability of Cr-Mo steels tested in accordance with the End Quenching Method (JIS G 0561). It reveals that higher-chromium steels possess greater hardenability. This tendency can also be observed in Cr-Mo weld metals. Higher hardness commonly causes lower ductility, thereby increasing susceptibility to cold cracking. For the latest information of the End Quenching Method, refer to JIS G 0561:2011.

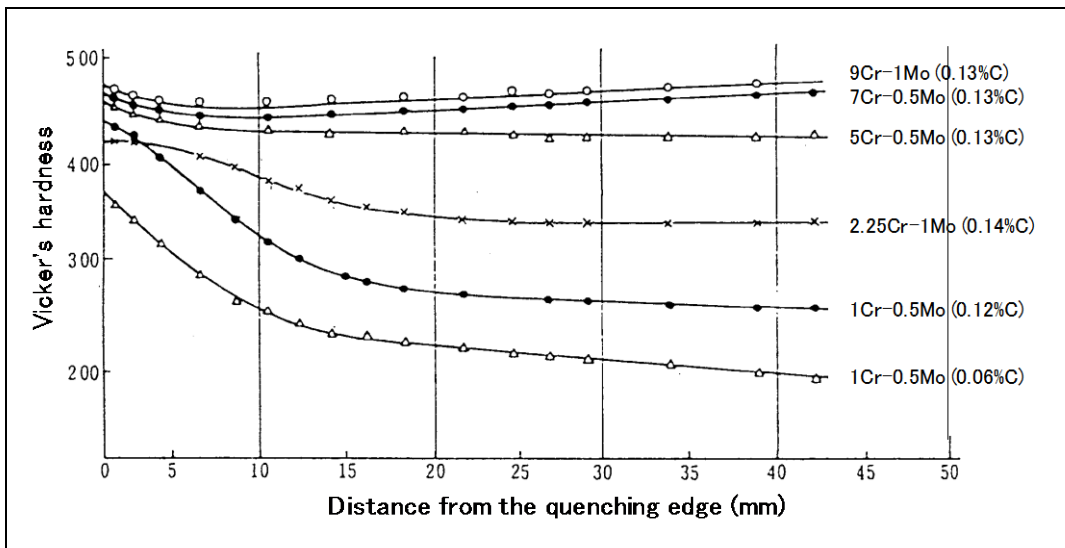

Fig. 2.3 — Hardenability of Cr-Mo steels tested in accordance with the End Quenching Method (JIS G 0561)

2.2 Cold cracking

Cold cracking may occur in welds of heat-resistant low-alloy steel, caused by the combined effects of low ductility of the weld, residual stresses and diffusible hydrogen in the weld. Cold cracking is also known as hydrogen-assisted cracking and hydrogen-induced cracking. It generally occurs at temperatures below 200°C immediately upon cooling, or after a period of several hours or days (Delayed cracking). The time taken before a cold crack occurs depends on the type of weld, the magnitude of welding stress (or plate thickness), and the hydrogen content of the weld and heat-affected zone. **Fig. 2.4** shows the critical diffusible hydrogen concentration in relation to the cold crack occurrence in submerged arc welded 2.25Cr-1Mo steel multiple-pass welds. It reveals that the highest hydrogen concentration, which causes cold cracking, is observed in the area around 20 to 30mm below the surface of the weld.

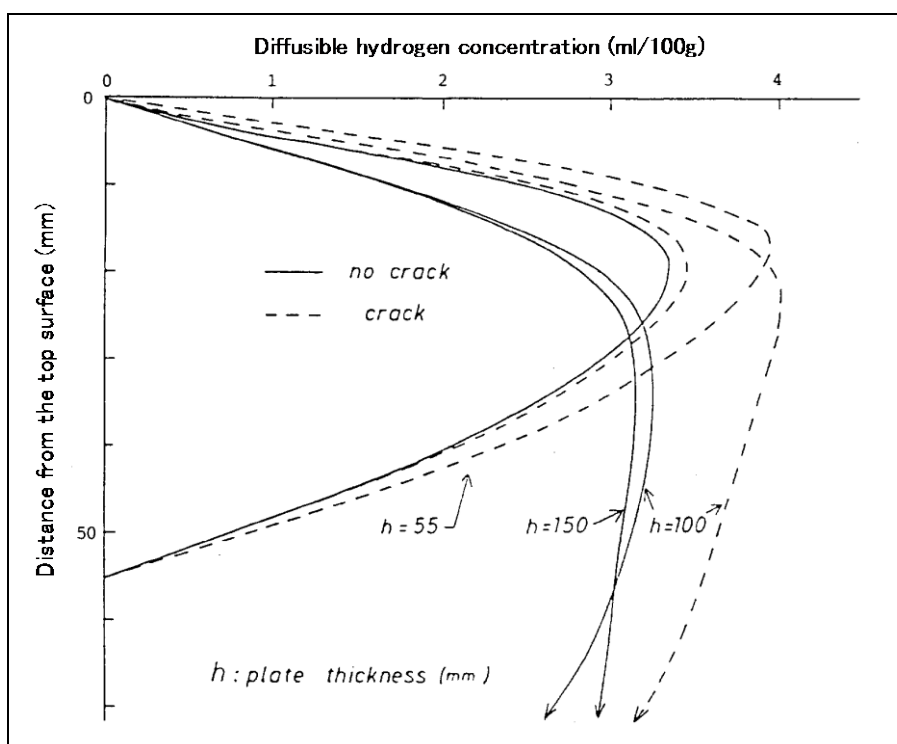

Fig. 2.4 — The effect of concentrated diffusible hydrogen on cold cracking for 2.25Cr-1Mo submerged arc weld metal

Cold cracking can be prevented by using low-hydrogen welding consumables to minimize diffusible hydrogen in the weld, preheating and postheating to release diffusible hydrogen from the weld, and proper welding procedures to minimize stress concentration in the weld. **Fig. 2.5** shows the y-groove restraint cracking test results of various steel welds including heat-resistant low-alloy steel welds. It clearly shows that preheating can prevent cold cracking and the minimum preheating temperature to prevent cold cracking depends on the type of steel. The heat-resistant low-alloy steel welds require higher preheating temperatures when compared with other types of steel. **Table 2.1** shows the chemical compositions and mechanical properties of the steel materials used in this test. **Fig. 2.6** shows that a thicker plate (up to 150 mm) requires higher preheating temperatures to prevent cold cracking.

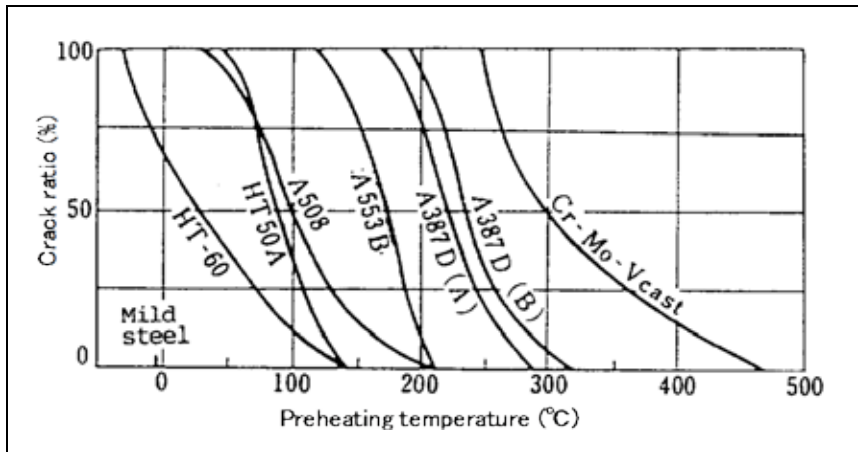

Fig. 2.5 — The effect of preheating temperature on the cracking susceptibility of various steel welds

Table 2.1 — Chemical composition and mechanical properties of the steels used for the y-groove restraint cracking test

Type of steel ⁽¹⁾	Plate thick. (mm)	Chemical composition (%)								Mechanical properties		
		C	Si	Mn	Cr	Ni	Mo	V	Cu	Y.S. (MPa)	T.S. (MPa)	El. (%)
Mild steel	35	0.13	0.18	0.88	—	—	—	—	—	284	451	28
HT-50A	32	0.16	0.39	1.35	—	—	—	—	—	372	539	23
HT-60	37	0.13	0.50	1.25	0.22	—	—	0.09	—	540	629	21
ASTM A533B	30	0.16	0.25	1.31	0.09	0.55	0.60	—	0.26	427	588	28
ASTM A387D (A)	32	0.08	0.16	0.42	2.06	—	0.93	—	—	441	608	23
ASTM A387D (B)	32	0.15	0.30	0.55	2.41	—	1.01	—	—	421	588	33
ASTM A508	32	0.16	0.34	0.66	0.37	0.78	0.59	—	—	510	638	28
Cr-Mo-V casting	30	0.18	0.45	0.69	1.05	0.29	0.98	0.26	0.14	621	711	25

Note: HT-50A and HT-60 are equivalent to 490- and 590-MPa HT, respectively.

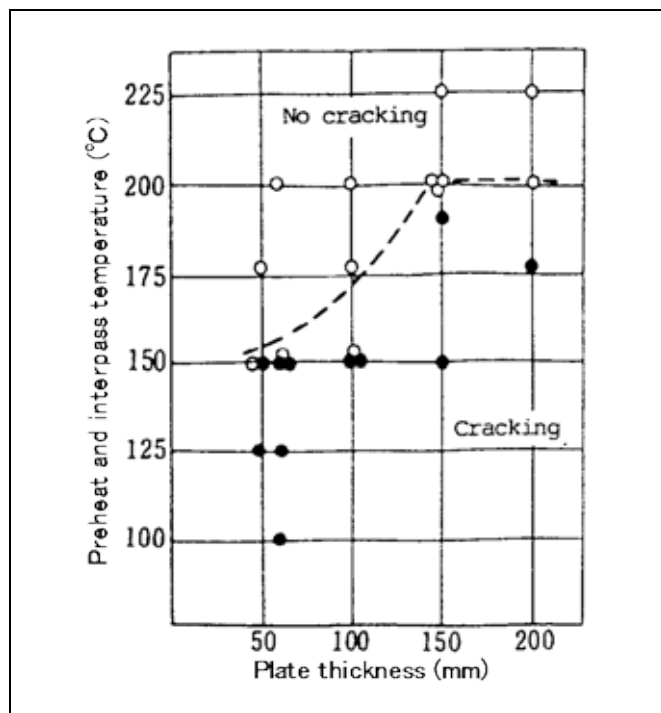

Fig. 2.6 — Crack test results of restrained 2.25Cr-1Mo steel welds by submerged arc welding

Fig. 2.7 shows the effects of immediate postheating (IPH) applied on the weld right after welding finished and postweld heat treatment (PWHT) on the diffusible hydrogen distribution in a thick-section 2.25Cr-1Mo steel weld. It obviously shows that IPH and, to a greater extent, PWHT reduce the concentration of diffusible hydrogen in the weld. Consequently, the cracking susceptibility of the weld can be reduced.

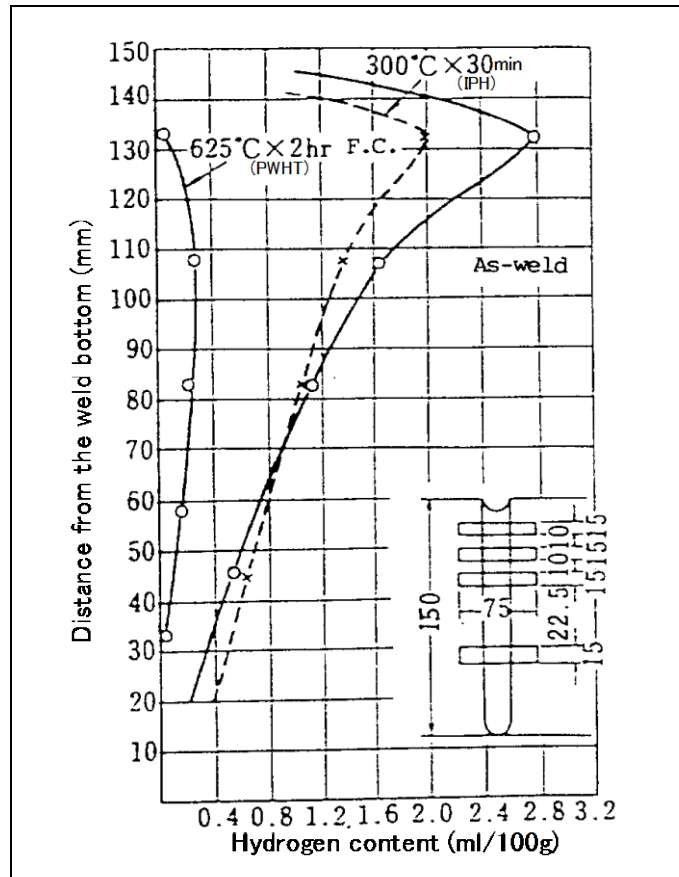

Fig.2.7 — The effects of postweld heat treatment (PWHT) and immediate postheating (IPH) on the diffusible hydrogen distribution in a thick-section 2.25Cr-1Mo steel weld (Preheating and interpass temperature: 200°C)

2.3 Hot cracking

The occurrence of cracks at high temperatures during solidification of heat-resistant low-alloy steel welds is affected by the weld chemical composition, the weld configuration, and the weld stresses. This type of cracking is known as hot cracking. It is referred to as a crack that develops in the high temperature range between liquidus and solidus or at temperatures little lower than the solidus of the weld. Hot cracks often occur at the grain boundaries of the weld. Hot cracking can be prevented by controlling the following:

- The amounts of impurity elements such as sulfur and phosphorus
- The weld configuration
- The amount of heat input

Fig. 2.8 shows the effect of weld configuration on the hot crack susceptibility of the weld. It suggests that the W/H ratio should be more than 1.0 in order to prevent hot cracking. **Fig. 2.9** shows the effect of heat input on the hot crack susceptibility of the weld. It suggests that heat input should be low in order to prevent hot cracking. **Photo 2.1** shows a macroscopic structure of the weld which contains hot cracks.

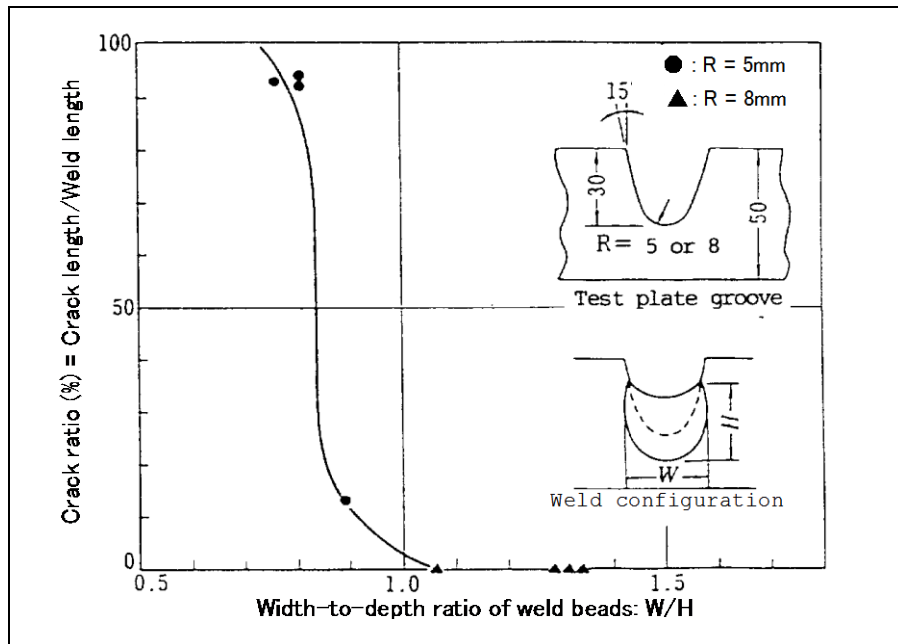

Fig. 2.8 — The effect of width-to-depth ratio (W/H) of weld metal on hot crack susceptibility of 2.25Cr-1Mo steel welds
 (Welding conditions in submerged arc welding — Wire size; 4.8mm ϕ ;
 Flux: fused type; Welding current: 650-700A; Arc voltage: 30V;
 Carriage speed: 30cm/min)

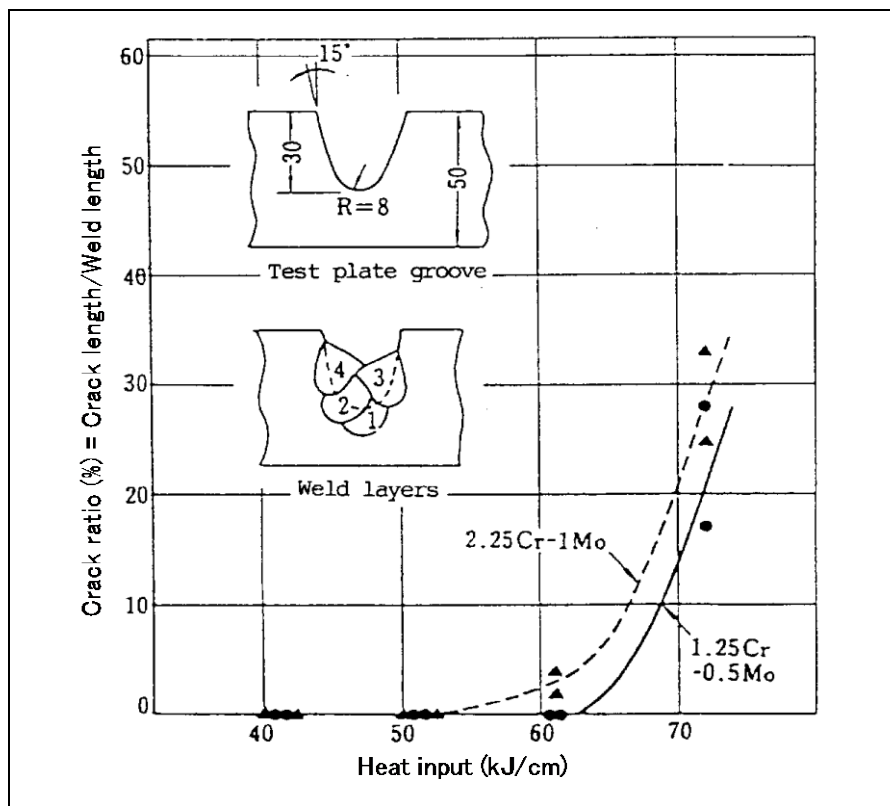

Fig. 2.9 — The effects of heat input on hot crack susceptibility of 1.25Cr-0.5Mo and 2.25Cr-1Mo steel welds
 (Welding conditions in submerged arc welding — Wire size: 4.8mm ϕ ;
 Flux: fused type; Welding current: 600-1000A; Arc voltage: 35V; Carriage speed: 30cm/min)

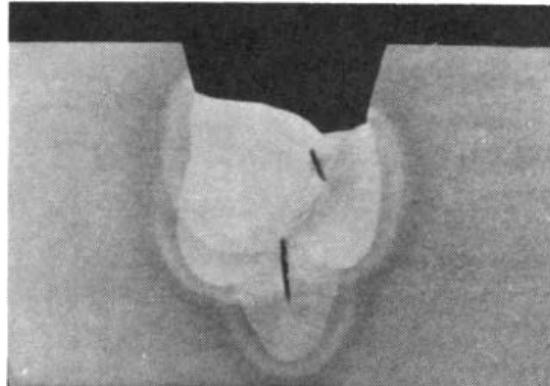

Photo 2.1 — Macroscopic structure of a 1.25Cr-0.5Mo steel weld containing hot cracks occurred in the test shown in Fig. 2.9

2.4 SR cracking

Weld cracks that may occur after stress-relief annealing or high-temperature service are known as SR cracking or reheat cracking, which may often occur in heat-resistant low-alloy steel welds. The factors that can affect the cracking are residual stresses, stress concentration, notches, SR temperature, and the chemical composition and microstructure of the weld. The coarse grain boundaries of the heat-affected zone of the base metal are more sensitive to SR cracking. Fig. 2.10 shows the SR cracking susceptibility of Cr-Mo steel as functions of SR temperature and additional alloying element. It clearly shows that temperatures around 600°C cause the highest crack susceptibility because of the precipitation hardening of the steel.

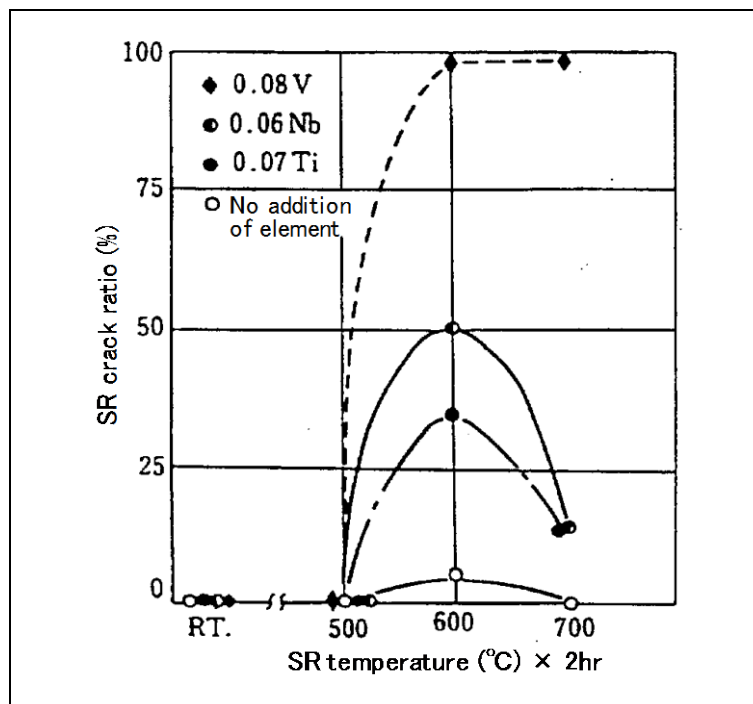

Fig. 2.10 — SR crack susceptibility of Cr-Mo steel (0.16%C, 0.30%Si, 0.60%Mn, 0.99%Cr, 0.46%Mo) as functions of SR temperature and additional alloying element (Results of y-groove restraint cracking test)

2.5 Effects of postweld heat treatment

Postweld heat treatment (PWHT) is usually referred to as stress-relief annealing (SR), though normalizing, quenching and tempering can be included when a weldment is subject to such heat treatment. Heat-resistant low-alloy steel welds, with the exception of thin plate welds, are generally subject to PWHT in order to

- relieve residual welding stresses,
- remove dissolved hydrogen,
- improve ductility and notch toughness,
- improve creep strength, and
- improve resistibility to hydrogen attack.

Fig. 2.11 shows the effect of PWHT on stress relieving as functions of soaking temperature and soaking time, which obviously shows that higher soaking temperature and longer soaking time lead to more reduction of residual stresses.

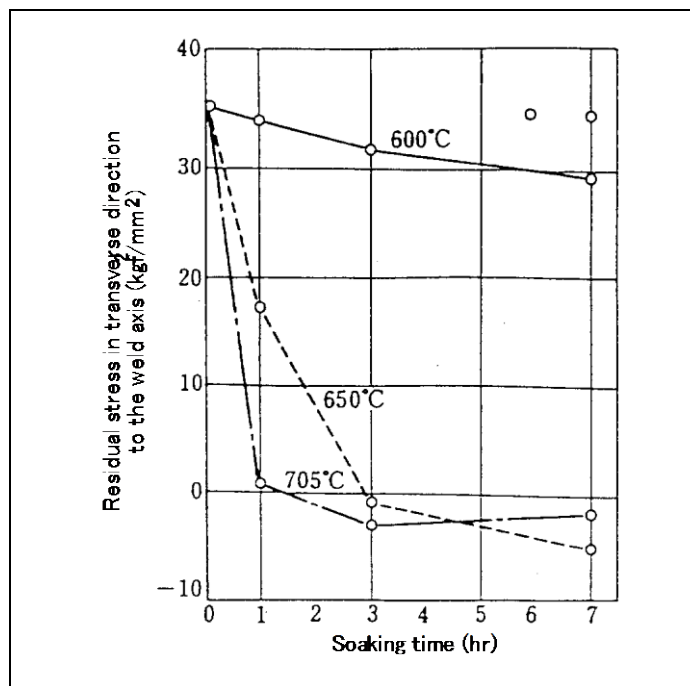

Fig. 2.11 — The effect of postweld heat treatment on stress relief of a 2.25Cr-1Mo steel weld ($1 \text{ kgf/mm}^2 = 9.8 \text{ MPa}$)

Fig. 2.12 shows plotted results of Vickers hardness test of 2.25Cr-1Mo steel welds (weld metal and heat-affected zone) as a function of the temper parameter (Rarson-Miller parameter) of PWHT given by the following formula.

$$P = T (\log t + 20)$$

Where T: Soaking temperature (K); t: Soaking time (hr)

It clearly shows that PWHT decreases the hardness of welds and thus implies that PWHT can improve the ductility of welds. **Fig. 2.13** shows the effect of PWHT on tensile properties of 1.25Cr-0.5Mo steel weld metals, which clearly shows that an increase in the temper parameter results in decreases in tensile strength and 0.2% proof strength as well as increases in elongation and reduction of area.

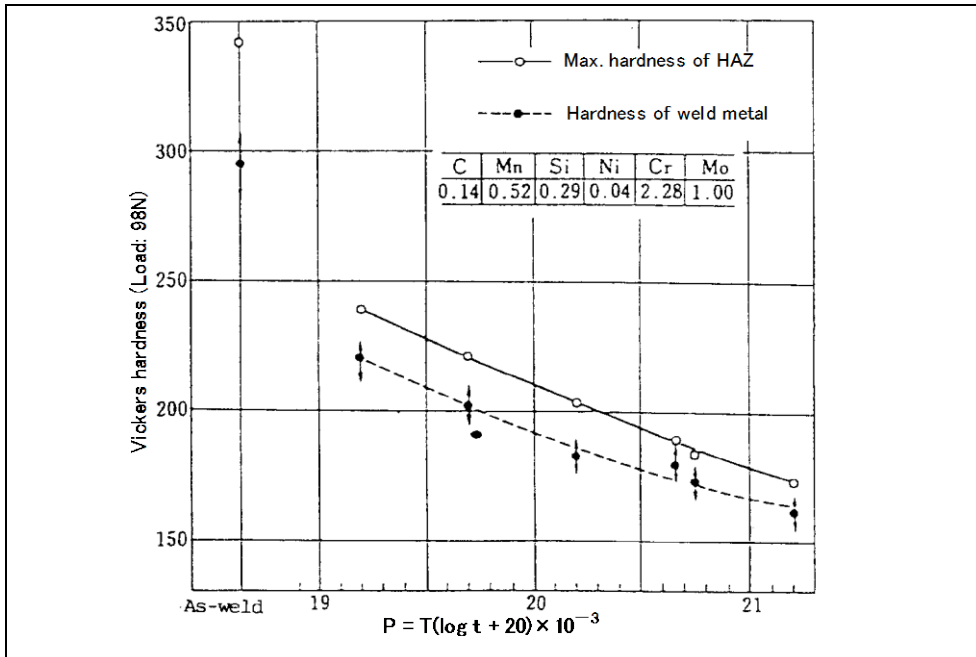

Fig. 2.12 — Vickers hardness of 2.25Cr-1Mo steel welds as a function of temper parameter (Base metal: A387 Gr. D, 150-mm thick.)

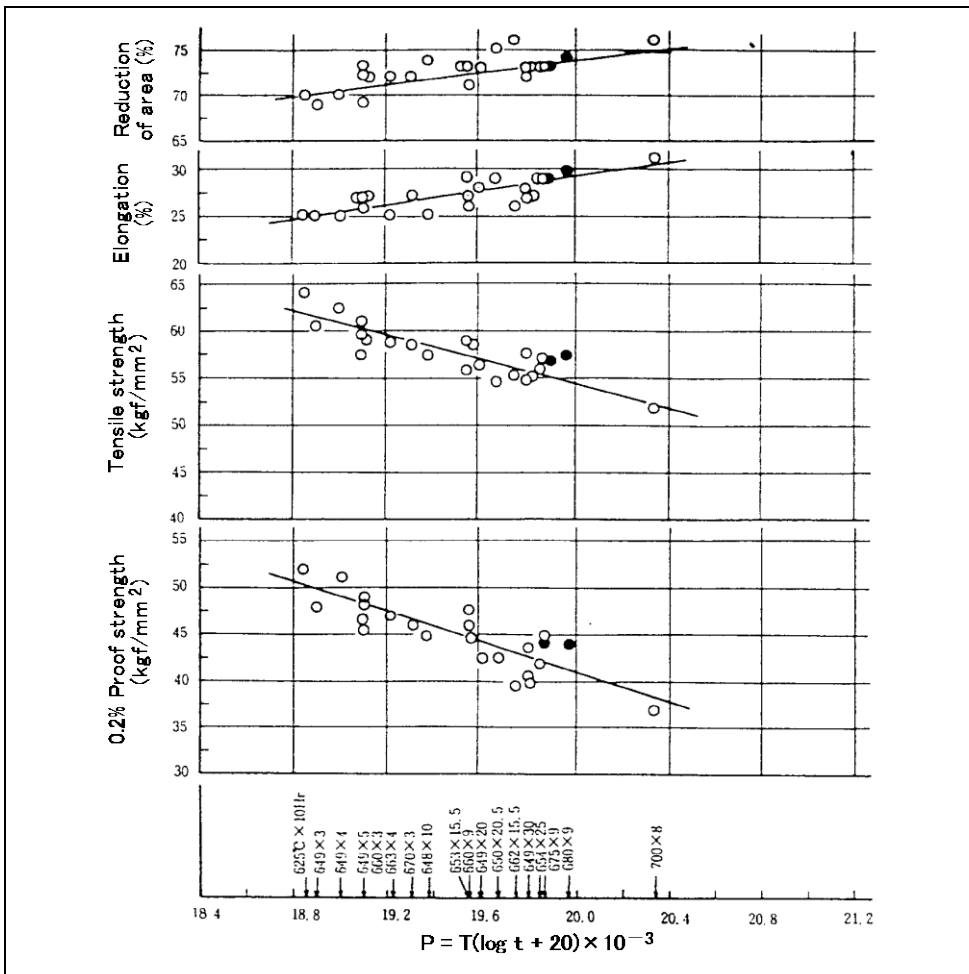

Fig. 2.13 — Mechanical properties of 1.25Cr-0.5Mo weld metals as a function of temper parameters (submerged arc welding: ○: single; ●: tandem) (1 kgf/mm² = 9.8 MPa)

Fig. 2.14 shows the relationship between the Charpy impact energies of 1.25Cr-0.5Mo weld metals and temper parameters. It is obvious, in the figure, that the impact energy is improved as the temper parameter increases up to a certain degree; however, an excessive temper parameter causes a decrease in impact energy. This is because excessive PWHT causes the precipitation of coarse grain ferrite, thereby reducing impact toughness of the weld metal.

Fig. 2.15 shows the effect of PWHT temperature on the creep rupture strength of 2.25Cr-1Mo weld metals, which reveals that 720°C provides higher strength for longer time service when compared with the other temperatures.

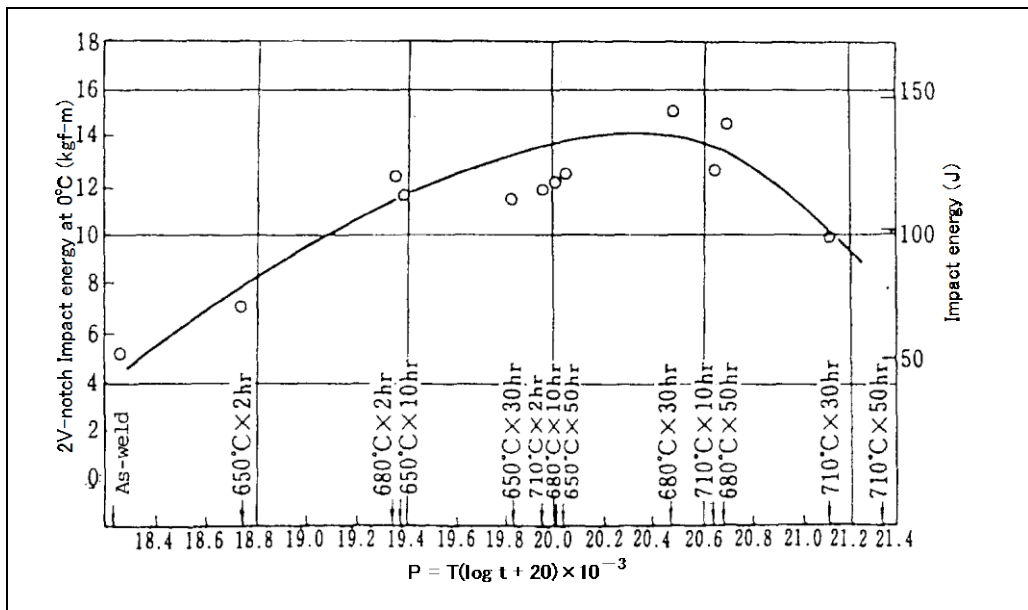

Fig. 2.14 — Charpy impact energy of 1.25Cr-0.5Mo weld metal as a function of temper parameter

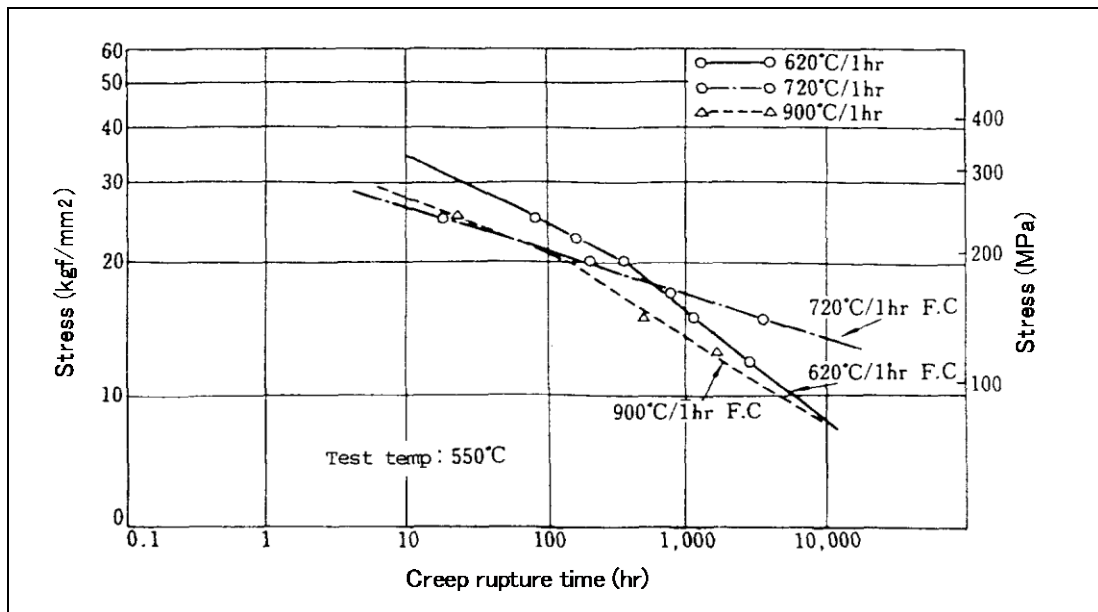

Fig. 2.15 — The effect of PWHT on creep rupture strength of 2.25Cr-1Mo weld metals

As mentioned referring to the test results of Fig. 2.14, excessive PWHT causes coarse-grain ferrite to precipitate along the pass-to-pass interface areas selectively in a weld metal as shown in **Photo 2.2**. This type of ferrite precipitation is called "ferrite band." Ferrite band is a decarburized phase. The PWHT conditions that cause ferrite band precipitation depend on the chemical composition of the weld metal. With the precipitation of ferrite bands, the tensile strength and impact absorbed energy of the weld metal decrease markedly. **Fig. 2.16** shows the effects of temperature and time on the ferrite band precipitation in a 2.25Cr-1Mo weld metal.

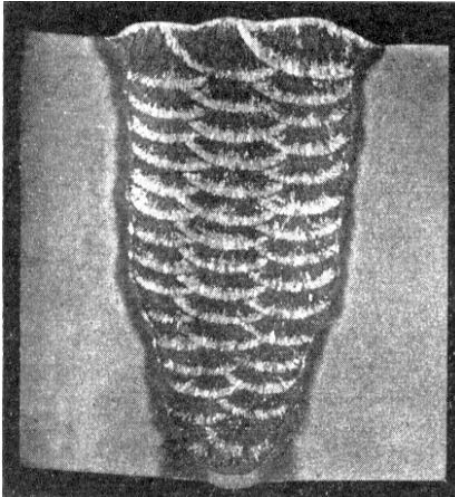

Photo 2.2 — Macroscopic structure of a 2.25Cr-1Mo steel weld containing ferrite bands

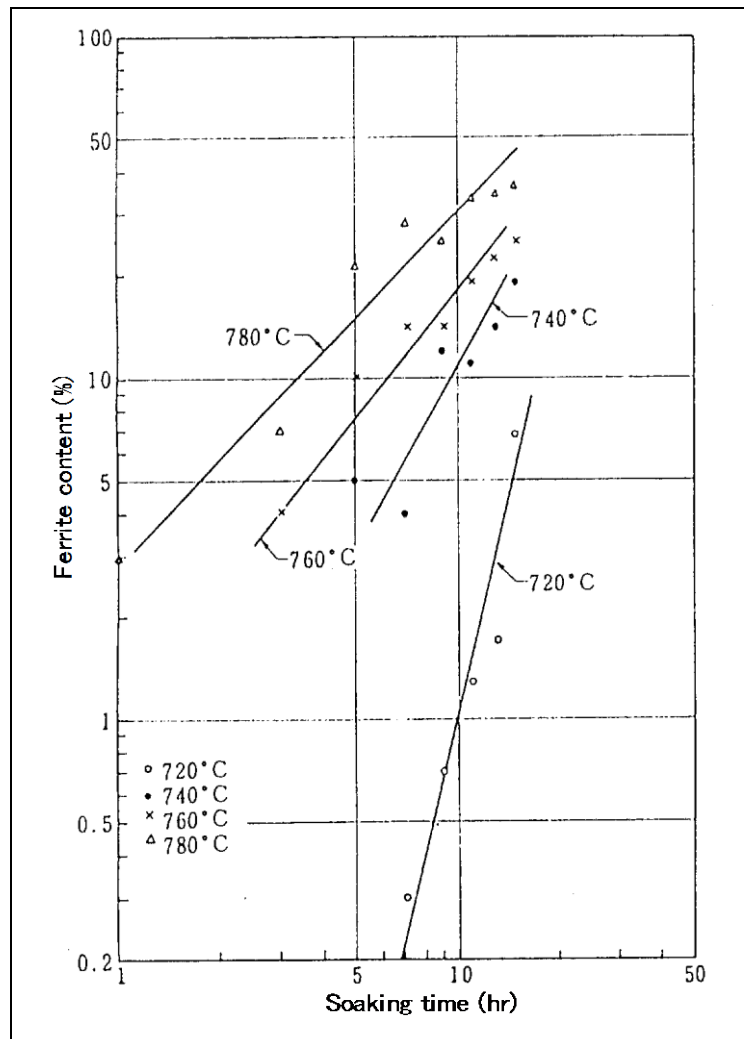

Fig. 2.16 — Ferrite band precipitation tendencies of 2.25Cr-1Mo weld metals as functions of soaking temperatures and time

2.6 Temper embrittlement

Temper embrittlement is the phenomenon in which the notch toughness of specific steels is considerably decreased by tempering or slowly cooling in the temperature range of 375-575°C. Such steels in particular are 2.25Cr-1Mo and 3Cr-1Mo steels, which are used in the reactor pressure vessels for high-temperature high-pressure services in oil refineries. The service temperatures of these pressure vessels generally fall in the range of 400-480°C. These pressure vessels, therefore, may be subject to temper embrittlement during a long time service. If the notch toughness of pressure vessels is deteriorated by temper embrittlement to a considerably low level, the concentrated stresses may cause fracture of the vessel when the metal temperature becomes low during shutdown operation, start-up operation, or hydraulic testing.

Temper embrittlement is believed to occur mainly at pre-austenitic grain boundaries of microscopic structure, caused by the segregation of impurity elements such as phosphorus, antimony, tin and arsenic diffused to the boundaries. The alloying elements of carbon, manganese, silicon, nickel, chromium and molybdenum are believed to accelerate the embrittlement. Several formulas that closely relate to temper embrittlement are suggested. The following formulas are commonly specified in the fabrication of the above-mentioned pressure vessels.

$$\bar{X} = (10P + 5Sb + 4Sn + As) \times 10^{-2}$$

$$J = (Mn + Si) \times (P + Sn) \times 10^4$$

where each chemical element is given by weight percentage.

Temper embrittlement is taken into account where 1.25Cr-0.5Mo, 2.25Cr-1Mo, and 3Cr-1Mo steels are used in specific pressure vessels in order to minimize temper embrittlement. **Fig. 2.17** shows a comparison of temper embrittlement susceptibility of various types of weld metals. It clearly shows that 2.25Cr-1Mo and 3Cr-1Mo weld metals are more susceptible than other types of weld metals. **Fig.2.18** shows the shift of notch toughness of a 2.25Cr-1Mo weld metal before and after the step-cooling heat treatment. **Fig.2.19** shows a step-cooling heat treatment cycle for accelerating the temper embrittlement in laboratory tests.

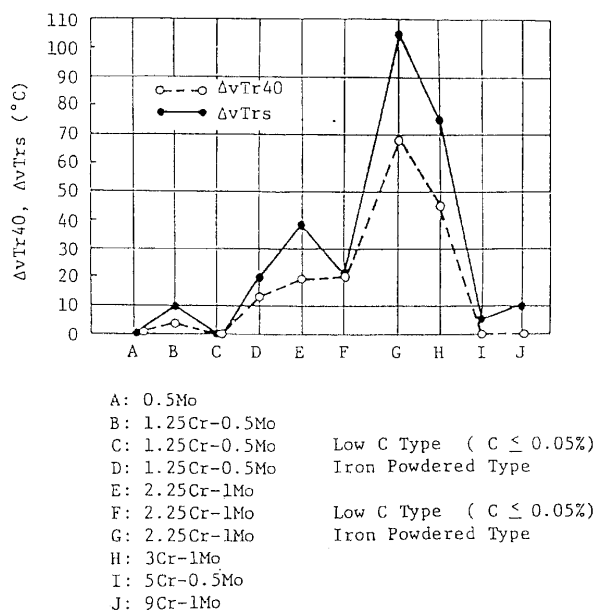

Fig. 2.17 — A comparison of various types of shielded metal arc welded Cr-Mo weld metals on temper embrittlement susceptibility

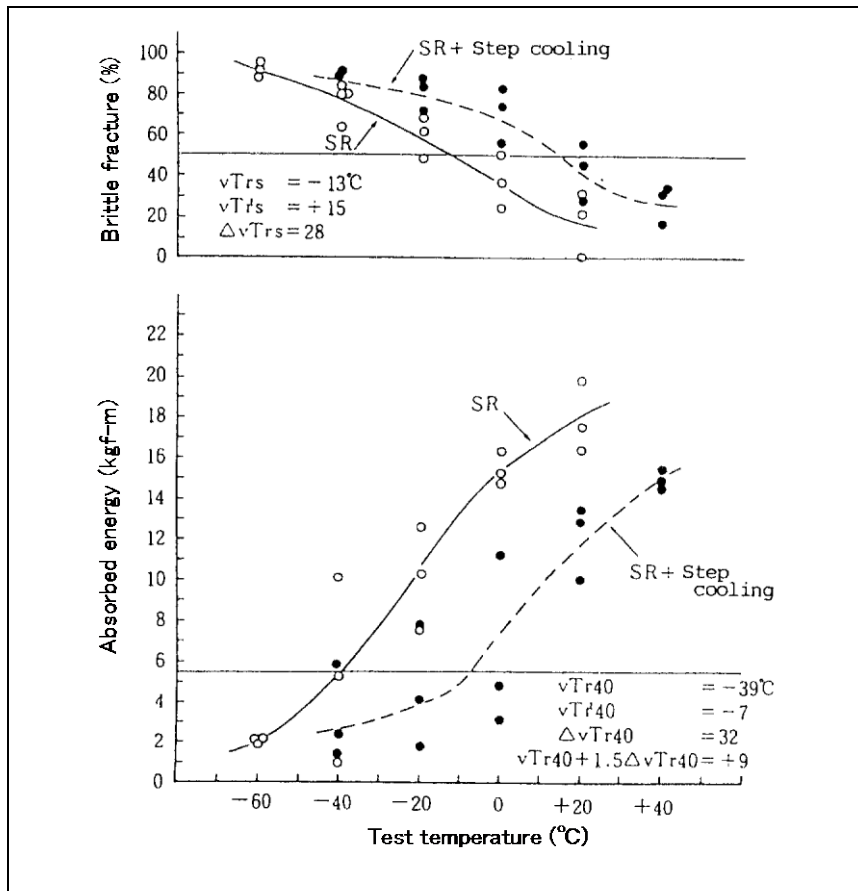

Fig. 2.18 — Temper embrittlement test results of a shield metal arc welded 2.25Cr-1Mo weld metal (1 kgf-m = 9.8 J)

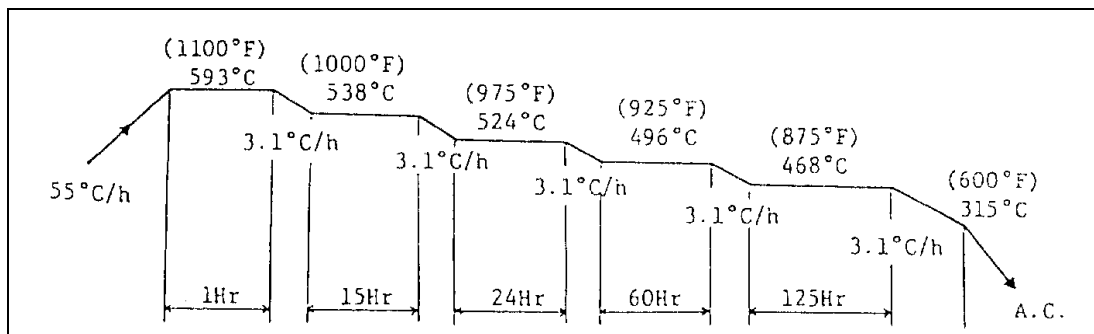

Fig. 2.19 — A step-cooling heat treatment cycle

2.7 Dissimilar-metal joints

Power plants, refineries and chemical plants use, as shown in Fig. 1.1, various types of metals resistible to the service temperatures, pressures and corrosive environments encountered in specific applications. In the construction of these facilities, dissimilar-metal joints are unavoidable to maximize the performance and minimize the material cost. This section discusses metallurgical problems encountered in welding dissimilar-metal joints and how to weld the joints, minimizing such problems.

2.7.1 Ferritic steel to ferritic steel

A dissimilar-metal joint consisting of carbon steel and 2.25Cr-1Mo steel, for example, can readily be welded with either a carbon steel filler metal, a 1.25Cr-0.5Mo steel filler metal, or a 2.25Cr-1Mo steel filler metal. The proper preheating temperature should generally be the same as that for the higher alloy, taking into account the weldability of the higher alloy. In cases where postweld heat treatment is specified, it should be conducted by using the proper temperature for the higher alloy, provided the temperature does not damage the lower alloy. Postweld heat treatment can cause a metallurgical discontinuity known as “carbon migration.” In the carbon migration in a weld, the carbon in the lower-chromium metal diffuses into the higher-chromium metal through the fusion line to precipitate a decarburized zone in the lower-chromium metal and a carburized zone in the higher-chromium metal, because of the strong affinity between chromium and carbon.

Fig. 2.20 and **photo 2.3** show test results of the carbon migration that took place in the fusion zone between 1.25Cr-0.5Mo base metal and 5Cr-0.5Mo weld metal. In this case, the carburized zone is precipitated in the higher-chromium weld metal adjacent to the fusion line, and the decarburized zone is precipitated in the lower-chromium base metal adjacent to the fusion line. This metallurgical discontinuity causes a drastic change of hardness across the fusion zone.

The extent of carbon migration is affected by the difference in the content of specific alloying elements that have great affinity with carbon between a lower alloy and a higher alloy of a welding joint, and by the soaking temperature and time of postweld heat treatment. By taking into account these factors, a correct welding procedure should be taken in order to minimize carbon migration. The metallurgical discontinuity caused by the carbon migration can deteriorate the bending properties and creep rupture properties of the weld joint.

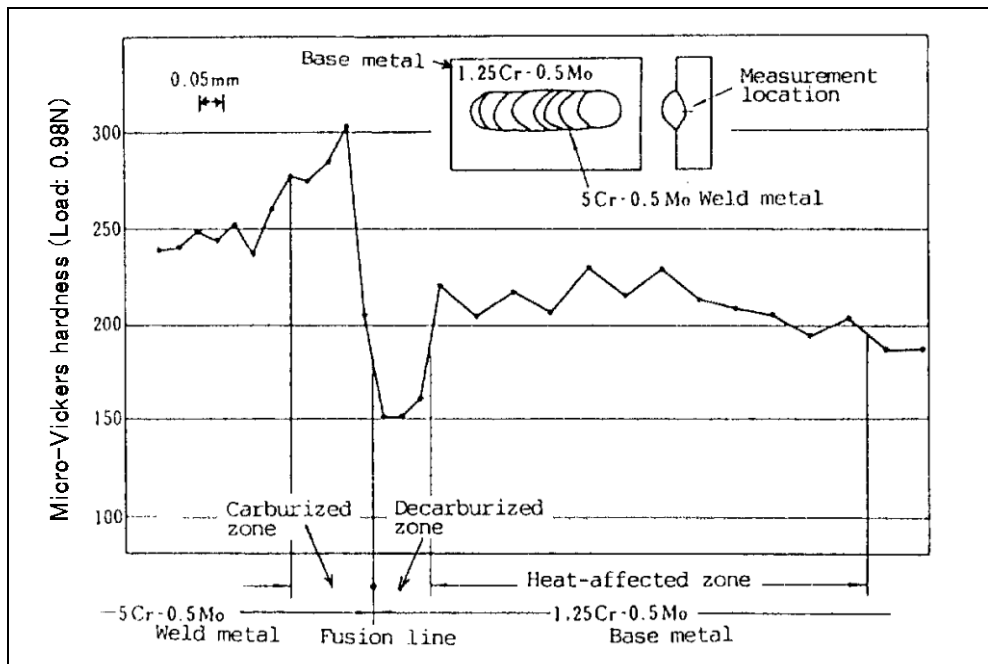

Fig. 2.20 — Hardness distribution of a dissimilar-metal weld consisting of 1.25Cr-0.5Mo base metal and a 5Cr-0.5Mo weld metal postweld heat treated at 700°C for 8hr

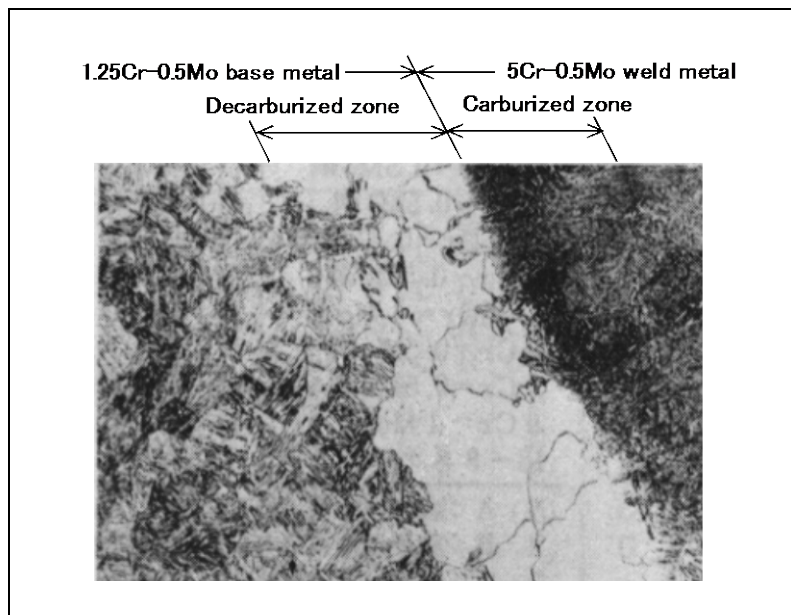

Photo 2.3 — Microscopic structure of a dissimilar metal weld after PWHT ($\times 150$)

- Base metal: 1.25Cr-0.5Mo
- Weld metal: 5Cr-0.5Mo
- PWHT: 700°C \times 8hr

2.7.2 Ferritic steel to austenitic steel

A dissimilar-metal joint of 2.25Cr-1Mo steel and 304-type stainless steel, for example, can readily be welded with either a 309-type filler metal or a Ni-Cr-Fe alloy filler metal. The preheating temperature should be the same as that for the ferritic steel. No preheating is needed for the austenitic stainless steel. When the joint is subject to postweld heat treatment or to high temperature service, a Ni-Cr-Fe alloy filler metal should be used in order to minimize the carbon migration and thermal fatigue fracture during service.

3. Welding processes and welding consumables

In welding heat-resistant low-alloy steels for general applications, various welding processes are used: shielded metal arc welding (SMAW), submerged arc welding (SAW), gas shielded metal arc welding (GMAW), and gas tungsten arc welding (GTAW). Each welding process uses specific welding consumables. The following sections discuss welding processes and welding consumables.

3.1 Welding processes and applications

3.1.1 Shielded metal arc welding (SMAW)

SMAW uses covered electrodes and can be applied to almost all the applications in out-of-position welding. Weld quality, however, is prone to vary depending on the skill of welders than in other welding processes. Welder's qualification and skill should therefore be carefully monitored. Either AC or DCEP current is used.

3.1.2 Submerged arc welding (SAW)

SAW uses a combination of flux and solid wire and can provide high welding efficiency due to high deposition rates and the mechanized nature of the process. SAW is applied to seam joints and girth joints in thick-section pressure vessels in the flat position. Either AC or DCEP current is used.

3.1.3 Gas shielded metal arc welding (GSMW)

In GSMW with a solid wire, CO₂ gas or a gas mixture of Ar+CO₂ (e.g. 80%Ar+20%CO₂) is generally used for shielding the weld pool. The transfer mode of molten metal droplets varies with welding amperage, arc voltage and the shielding gas composition. The metal transfer mode affects the applicable welding position. The globular transfer arc with high currents and CO₂ gas is suitable for the flat and horizontal fillet positions. The spray transfer arc with high currents and Ar+CO₂ gas mixture is also suitable for the flat and horizontal positions, which offers lower spatter and higher impact values when compared with the globular transfer arc. The short-circuiting transfer arc with low currents and CO₂ or Ar+CO₂ is suitable for out-of-position welding of thin section workpieces. The pulsed-arc welding with Ar+CO₂ is also suitable for out-of-position welding, which facilitates better penetration than with the short-circuiting arc.

GSMW can be carried out semi-automatically by manually manipulating the torch, and automatically by manipulating the torch with a mechanized process. DCEP current is used in general.

3.1.4 Gas tungsten arc welding (GTAW)

Typical applications of the GTAW process are root-pass welding of pipe-to-pipe joints and fillet welding of tube-to-tube sheet joints. GTAW can be applied for out-of-position welding by using either a manual or automatic process. DCEN current is used in general applications.

3.2 Types and features of welding consumables

3.2.1 Covered electrodes for shielded metal arc welding

Table 3.1 shows various types of covered electrodes specified by AWS A5.5:2014 (Low-Alloy Steel Electrodes for Shielded Metal Arc Welding). For welding heat-resistant low-alloy steels, low-hydrogen type and iron-powder low-hydrogen type covered electrodes are commonly used because of better crack resistibility and mechanical properties. The iron-powder low-hydrogen type electrodes offer higher deposition rates and better usability in DC welding when compared with usual low-hydrogen type electrodes.

JIS Z 3223:2010 (Covered Electrodes for Molybdenum Steel and Chromium Molybdenum Steel) specifies high-titanium-oxide type covered electrodes in addition to the low-hydrogen type and iron-powder low-hydrogen type covered electrodes equivalent to those specified in AWS A5.5:2014. The high-titanium-oxide type electrodes are beneficial in the welding of thin tubes due to shallow penetration and in surface-dressing welding due to smooth bead appearance.

The low-carbon type covered electrodes (e.g. E8015-B3L) are only for DCEP current. They are suitable for the applications where the heating temperatures for preheating and postweld heat treatment are limited.

Table 3.1 — Typical covered electrodes for heat-resistant low-alloy steels (Excerpted from AWS A5.5:2014)

Classification (1)	Type of covering	Type of current	Chemical composition of deposited metal (%)								Mechanical properties of deposited metal			PWHT for mechanical test
			C	Mn	Si	S	P	Ni	Cr	Mo	Tensile strength (ksi)	0.2% proof strength (ksi)	Elongation (%)	
E7016-A1	Low hydrogen	AC or DC-EP	0.12 max	0.90 max	0.60 max	0.03 max	0.03 max	—	—	0.40-0.65	70 min	57 min	22 min	1150 ± 25°F × 1hr
E7015-B2L	Low hydrogen	DC-EP	0.05 max	0.90 max	1.00 max	0.03 max	0.03 max	1.00-1.50	—	0.40-0.65	75 min	57 min	19 min	1275 ± 25°F × 1hr
E8016-B2	Low hydrogen	AC or DC-EP	0.05-0.12	0.90 max	0.60 max	0.03 max	0.03 max	1.00-1.50	—	0.40-0.65	80 min	67 min	19 min	1275 ± 25°F × 1hr
E8018-B2	low hydrogen Iron powder	AC or DC-EP	0.05-0.12	0.90 max	0.80 max	0.03 max	0.03 max	1.00-1.50	—	0.40-0.65	80 min	67 min	19 min	1275 ± 25°F × 1hr
E8015-B3L	Low hydrogen	DC-EP	0.05 max	0.90 max	1.00 max	0.03 max	0.03 max	2.00-2.50	—	0.90-1.20	80 min	67 min	17 min	1275 ± 25°F × 1hr
E9016-B3	Low hydrogen	AC or DC-EP	0.05-0.12	0.90 max	0.60 max	0.03 max	0.03 max	2.00-2.50	—	0.90-1.20	90 min	77 min	17 min	1275 ± 25°F × 1hr
E9018-B3	low hydrogen Iron powder	AC or DC-EP	0.05-0.12	0.90 max	0.80 max	0.03 max	0.03 max	2.00-2.50	—	0.90-1.20	90 min	77 min	17 min	1275 ± 25°F × 1hr
E8016-B6	Low hydrogen	AC or DC-EP	0.05-0.10	1.0 max	0.90 max	0.03 max	0.03 max	4.0-6.0	0.4 max	0.45-0.65	80 min	67 min	19 min	1375 ± 25°F × 1hr
E8016-B8	Low hydrogen	AC or DC-EP	0.05-0.10	1.0 max	0.90 max	0.03 max	0.03 max	8.0-10.5	0.4 max	0.85-1.20	80 min	67 min	19 min	1375 ± 25°F × 1hr
E9015-B91	Low hydrogen	DC-EP	0.08-0.13	1.20 max	0.30 max	0.01 max	0.01 max	8.0-10.5	0.80 max	0.85-1.20	90 min	77 min	17 min	1400 ± 25°F × 2hr
E9016-B91	Low hydrogen	AC or DC-EP	0.08-0.13	1.20 max	0.30 max	0.01 max	0.01 max	8.0-10.5	0.80 max	0.85-1.20	90 min	77 min	17 min	1400 ± 25°F × 2hr

Note:

(1) Classification system of EXXXX-X

• E: designates an electrode.

• 70/80/90: indicates the minimum tensile strength (in ksi) of the weld metal.

• The third and fourth digits taken together denote the suitable welding position, the type of covering and the proper type of current.

• The last combination of suffixes indicates the chemical composition of the undiluted weld metal.

3.2.2 Welding wires and fluxes for submerged arc welding

Submerged arc welding uses a combination of wire and flux; therefore, filler metal standards specify both wires and fluxes. **Table 3.2** shows AWS A5.23:2011 (Low-Alloy Steel Electrodes and Fluxes for Submerged Arc Welding). Solid wires are classified according to the chemical composition. Fluxes are classified according to the chemical composition and mechanical properties of the weld metal they produce with a certain classification of wire, under the specified test conditions. Fluxes used for welding heat-resistant low-alloy steels are commonly of the neutral type, which are suitable for multiple-pass welding for thick section steels. The neutral fluxes are defined as those which will not produce any significant change in the weld metal manganese and silicon content as a result of a large change in the arc voltage, and thus, the arc length. As for the JIS standard, refer to Z 3352:2010 (Fluxes for Submerged Arc Welding) and Z 3351:2012 (Submerged Arc Welding Solid Wires for Carbon Steel and Low Alloy Steel).

Table 3.2 — Classifications and requirements for submerged arc welding solid wires and fluxes for heat-resistant low-alloy steels (Excerpted from AWS A5.23:2011)

Class.	Main chemical composition (%)										
	C	Mn	Si	Cr	Mo	Ni	V	Nb	N	Al	
Wire	EA3	0.05-0.17	1.65-2.20	0.20 max	—	0.45-0.65	—	—	—	—	—
	EA4	0.05-0.15	1.20-1.70	0.20 max	—	0.45-0.65	—	—	—	—	
	EB2	0.07-0.15	0.45-1.00	0.05-0.30	1.00-1.75	0.45-0.65	—	—	—	—	
	EB3	0.05-0.15	0.40-0.80	0.05-0.30	2.25-3.00	0.90-1.10	—	—	—	—	
	EB6	0.10 max	0.35-0.70	0.05-0.50	4.50-6.50	0.45-0.70	—	—	—	—	
	EB91	0.07-0.13	1.25 max	0.50 max	8.50-10.50	0.85-1.15	1.00 max	0.15-0.25	0.02-0.10	0.03-0.07	0.04 max
	EG	Not specified									
Weld metal	A3	0.15 max	2.10 max	0.80 max	—	0.40-0.65	—	—	—	—	
	A4	0.15 max	1.60 max	0.80 max	—	0.40-0.65	—	—	—	—	
	B2	0.05-0.15	1.20 max	0.80 max	1.00-1.50	0.40-0.65	—	—	—	—	
	B3	0.05-0.15	1.20 max	0.80 max	2.00-2.50	0.90-1.20	—	—	—	—	
	B6	0.12 max	1.20 max	0.80 max	4.50-6.00	0.40-0.65	—	—	—	—	
	B91	0.08-0.13	1.20 max	0.80 max	8.0-10.5	0.85-1.20	0.80 max	0.15-0.25	0.02-0.10	0.02-0.07	0.04 max
	G	As agreed between supplier and purchaser									

Classification	Tensile properties of weld metal			
	Tensile strength (ksi)	0.2% proof strength (ksi)	Elongation (%)	
Flux	F7XX-EXX-XX	70-95	58 min	22 min
	F8XX-EXX-XX	80-100	68 min	20 min
	F9XX-EXX-XX	90-110	78 min	17 min
	F10XX-EXX-XX	100-120	88 min	16 min

Impact properties of weld metal	
Digit	Charpy impact energy, average (ft-lbf)
0	20 min at 0°F
2	20 min at -20°F
4	20 min at -40°F
5	20 min at -50°F
6	20 min at -60°F
8	20 min at -80°F
10	20 min at -100°F
15	20 min at -150°F
Z	Not required

An example of flux designation: **F9P0-EB3-B3**
 F: designates a flux.
 9: represents 90ksi of the minimum tensile strength of the weld metal.
 P: indicates that the weld metal was tested and classified in the postweld heat-treated condition.
 0: designates 0°F as the temperature at which the weld metal meets the required 20ft-lbf Charpy impact energy.
 EB3: designates a solid wire having the chemical composition specified as to EB3.
 B3: indicates the chemical composition of the weld metal specified as to B3.

3.2.3 Welding wires for gas shielded metal arc welding

For gas shielded metal arc welding of heat-resistant low-alloy steels, solid wires and flux-cored wires are available. For example, AWS A5.28:2005 (Low-Alloy Steel Electrodes and Rods for Gas Shielded Arc Welding) specifies solid wires, and AWS A5.29:2010 (Low-Alloy Steel Electrodes for Flux Cored Arc Welding) specifies flux-cored wires. **Table 3.3** shows typical solid wires excerpted from the AWS specification. The chemical composition and mechanical properties of weld metals are affected by the shielding gas; therefore, filler metal standards specify the type of shielding gas for testing the specified welding wires. As for the JIS standard, refer to Z 3317:2011 (Solid Wire Electrodes, Wires and Rods for Gas-Shielded Arc Welding of Molybdenum Steel and Chromium Molybdenum Steel) and Z 3318:2010 (Flux Cored Wires for MAG Welding of Molybdenum Steel and Chromium Molybdenum Steel).

Table 3.3 — Classifications and requirements for solid wires for gas shielded metal arc welding of heat-resistant low alloy steels (Excerpted from AWS A5.28-2005)

Classification ⁽¹⁾	Chemistry of solid wires and weld metal of flux-cored wires (%) with shielding gas ⁽²⁾									
	C	Mn	Si	S	P	Cr	Mo	Ni	V	Al
ER70S-A1	0.12 max	1.30 max	0.30- 0.70	0.025 max	0.025 max	—	0.40- 0.65	0.20 max	—	—
ER80S-B2	0.07- 0.12	0.40- 0.70	0.40- 0.70	0.025 max	0.025 max	1.20- 1.50	0.40- 0.65	0.20 max	—	—
ER90S-B3	0.07- 0.12	0.40- 0.70	0.40- 0.70	0.025 max	0.025 max	2.30- 2.70	0.90- 1.20	0.20 max	—	—
ER80S-B6	0.10 max	0.40- 0.70	0.50 max	0.025 max	0.025 max	4.50- 6.00	0.45- 0.65	0.60 max	—	—
ER80S-B8	0.10 max	0.40- 0.70	0.50 max	0.025 max	0.025 max	8.00- 10.5	0.80- 1.20	0.50 max	—	—
ER90S-B9	0.07- 0.13	1.20 max	0.15- 0.30	0.010 max	0.010 max	8.00- 10.5	0.85- 1.20	0.80 max	0.15- 0.30	0.04 max
ERXXS-G	As agreed between purchaser and supplier (Ni ≥ 0.50%, Cr ≥ 0.30%, or Mo ≥ 0.20%)									

Classification ⁽¹⁾	Mechanical properties of weld metal			Shielding gas ⁽²⁾	Preheat and interpass temperature (°F)	PWHT temperature for test (°F)
	Tensile strength (ksi)	0.2% proof strength (ksi)	Elongation (%)			
ER70S-A1	75 min	58 min	19 min	Ar/1-5%O ₂	275-325	1150 ± 25
ER80S-B2	80 min	68 min	19 min	Ar/1-5%O ₂	275-325	1150 ± 25
ER90S-B3	90 min	78 min	17 min	Ar/1-5%O ₂	375-425	1275 ± 25
ER80S-B6	80 min	68 min	17 min	Ar/1-5%O ₂	350-450	1375 ± 25
ER80S-B8	80 min	68 min	17 min	Ar/1-5%O ₂	400-500	1375 ± 25
ER90S-B9	90 min	60 min	16 min	Ar/5%CO ₂	400-600	1400 ± 25
ERXXS-G	As agreed between purchaser and supplier (Tensile strength shall be those above)					

Note: (1) Classification system

A5.28 ERXXS-XX — E: Electrode; R: Rod; 70/80/90: Min. TS (in ksi) of the weld metal; S: Solid wire; A1/B2/B3/B6/B8/B9/G: Chemistry of solid wire (G: General).

(2) Classification with other gas blends shall be as agreed upon between purchaser and supplier.

Fig. 3.1 shows the effect of shielding gas composition on the Charpy impact absorbed energy of weld metals. It clearly shows that the impact energy of the weld metals decreases as the percentage of CO₂ in the shielding gas increases. This is because the chemical composition of weld metals is affected by the decomposition of CO₂ (CO₂ → CO + O) at high temperatures in the arc atmosphere — Fig. 3.2. A gas shielded metal arc welding wire should, therefore, be used with the shielding gas having the composition suitable for the wire and its application.

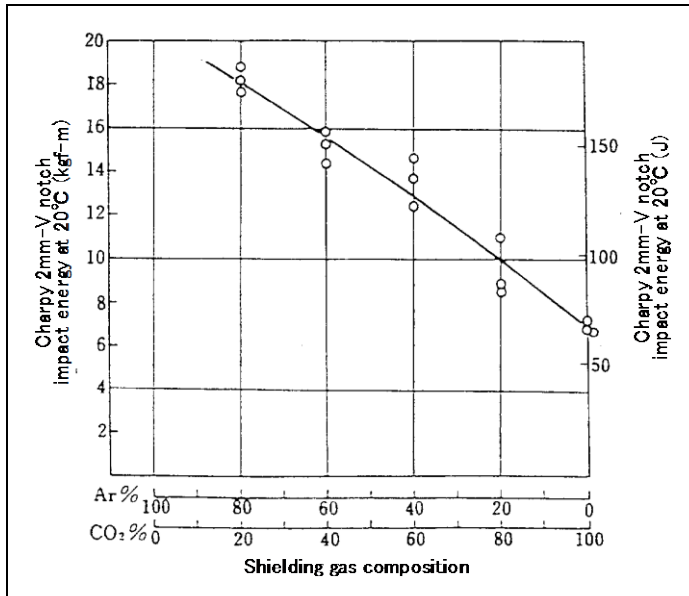
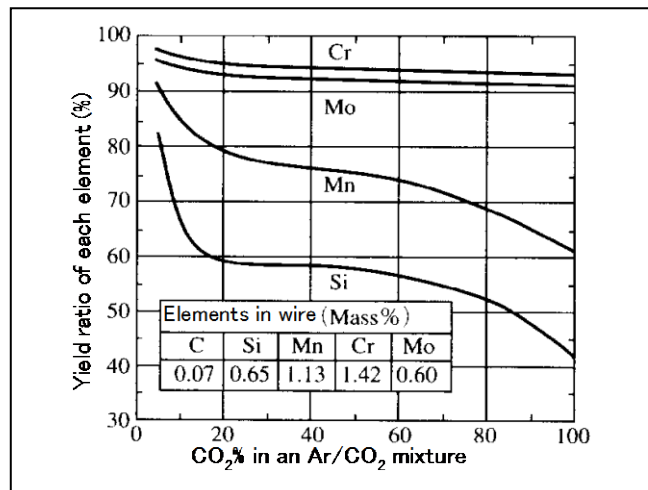

Fig. 3.1 — The effect of shielding gas composition on Charpy impact absorbed energy of 1.25Cr-0.5Mo weld metals (PWHT: 690°C×1hr)

Fig. 3.2 — Yield ratios of chemical elements in a 1.25Cr-0.5Mo weld metal as a function of CO₂% in an Ar/CO₂ mixture



3.2.4 Welding wires for gas tungsten arc welding

Table 3.4 shows typical filler wires for gas tungsten arc welding (GTAW) of heat-resistant low-alloy steels, which are excerpted from Z 3317:2011 (Solid Wire Electrodes, Wires and Rods for Gas-Shielded Arc Welding of Molybdenum Steel and Chromium Molybdenum Steel). As for the AWS standard, refer to A5.28:2005 (Low-Alloy Steel Electrodes and Rods for Gas Shielded Arc Welding). In GTAW, an inert gas such as pure argon is commonly used for shielding the arc; therefore, the chemical composition of the weld metal results in almost the same as that of the filler wire. Filler wires for GTAW are available in cut rod and spooled wire. Cut rods are used for manual welding, while spooled wires are suitable for automatic welding processes.

Table 3.4 — Typical filler wires for gas tungsten arc welding of heat-resistant low-alloy steels (Excerpted from JIS Z 3317-2011)

Class.	Main chemical composition of wire (%)												
	C	Mn	Si	Cr	Mo	Ni	V	Nb	W	Co	Al	N	Others
1M3	0.12 max	1.30 max	0.30-0.70	—	0.40-0.65	0.20 max	—	—	—	—	—	—	—
1CM	0.07-0.12	0.40-0.70	0.40-0.70	1.20-1.50	0.40-0.65	0.20 max	—	—	—	—	—	—	—
1CM3	0.12 max	0.80-1.50	0.30-0.90	1.00-1.60	0.40-0.65	—	—	—	—	—	—	—	—
1CML1	0.05 max	0.80-1.40	0.20-0.80	1.00-1.60	0.40-0.65	—	—	—	—	—	—	—	—
2C1M	0.07-0.12	0.40-0.70	0.40-0.70	2.30-2.70	0.90-1.20	0.20 max	—	—	—	—	—	—	—
2C1M2	0.05-0.15	0.50-1.20	0.60 max	2.10-2.70	0.85-1.20	—	—	—	—	—	—	—	—
2C1ML1	0.05 max	0.80-1.40	0.30-0.90	2.10-2.70	0.90-1.20	—	—	—	—	—	—	—	—
2CMWV	0.12 max	0.20-1.00	0.10-0.70	2.00-2.60	0.45-0.65	—	0.10-0.50	0.01-0.08	1.00-2.00	—	—	—	—
5CM	0.10 max	0.40-0.70	0.50 max	4.50-6.00	0.45-6.00	0.60 max	—	—	—	—	—	—	—
9C1MV	0.07-0.13	1.20 max	0.15-0.50	8.00-10.50	0.85-1.20	0.80 max	0.15-0.30	0.02-0.10	—	—	0.04 max	0.03-0.07	Mn+Ni: 1.50 max
9C1MV1	0.12 max	0.50-1.25	0.50 max	8.00-10.50	0.80-1.20	0.10-0.80	0.10-0.35	0.01-0.12	—	—	—	0.01-0.05	—
10CMWV-Co	0.12 max	0.20-1.00	0.10-0.70	9.00-11.50	0.20-0.55	0.30-1.00	0.10-0.50	0.01-0.08	1.00-2.00	0.80-1.20	—	0.02-0.07	—

Class.	Mechanical properties of deposited metal				Preheat & interpass temp. (°C)	PWHT (°C×hr)
	Classification of chemistry (See above)	Tensile strength (MPa)	0.2% proof strength (MPa)	Elongation (%)		
52	1M3	520 min	400 min	17 min	135-165	605-635×1
	1CML1	520 min	400 min	17 min	135-165	675-705×1
	2CMWV	520 min	400 min	17 min	160-190	700-730×2
55	1CM	550 min	470 min	17 min	135-165	605-635×1
	1CM3	550 min	470 min	17 min	135-165	675-705×1
	2C1ML1	550 min	470 min	15 min	185-215	675-705×1
	5CM	550 min	470 min	15 min	175-235	730-760×1
62	2C1M, 2C1M2	620 min	540 min	15 min	185-215	675-705×1
	9C1MV, 9C1MV1	620 min	410 min	15 min	205-320	745-775×2
	10CMWV-Co	620 min	530 min	15 min	205-260	725-755×8

Note: (1) Classification system: e.g. W 52-1CML1

•W: designates TIG welding with Ar shielding.

•52: designates the minimum tensile strength in 10 MPa.

•1CML1: designates the chemical composition of the rod and wire.

3.2.5 Advanced welding consumables

In addition to the aforementioned welding consumables for high temperature applications, the advanced welding consumables are available, which match the advanced steels discussed in Section 1. The advanced welding consumables for 2.25Cr-1Mo-0.25V steel are shown in **Table 3.5**; those for 9Cr-1Mo-V-Nb steel are shown in **Table 3.6**.

Table 3.5 — Typical chemical composition and mechanical properties of welding consumables for 2.25Cr-1Mo-0.25V steel suitable for hydrotreating high-temperature high-pressure vessels

Typical steel	Welding process	Brand name ⁽¹⁾	Typical chemical composition (%) ⁽²⁾								
			C	Mn	Si	P	S	Cr	Mo	V	Nb
ASTM A542 Type D Cl.4a	SMAW (DCEP)	CM-A106HD	0.07	0.87	0.24	< 0.01	< 0.01	2.34	1.01	0.30	0.018
	GTAW (DCEN)	TG-S2CMH	0.12	0.41	0.16	0.004	0.007	2.31	1.06	0.28	0.033
	SAW (DCEP)	PF-500D/US-521HD	0.08	0.78	0.12	0.008	0.001	2.42	1.00	0.31	0.017

Typical steel	Welding process	Brand name ⁽¹⁾	Typical mechanical properties of weld metal				PWHT (°C × hr)
			Tensile strength (MPa)	0.2% proof strength (MPa)	Elongation (%)	Charpy impact energy (J)	
ASTM A542 Type D Cl.4a	SMAW (DCEP)	CM-A106HD	713	598	21	121 at -18°C	705 x 8
	GTAW (DCEN)	TG-S2CMH	730	623	22	300 at -18°C	705 x 7
	SAW (DCEP)	PF-500D/US-521HD	693	593	25	130 at -18°C	705 x 8

Note: (1) Trade designations of filler metals produced by Kobe Steel.

(2) The chemical composition of the weld metal for SMAW and SAW and of the wire for GTAW.

Table 3.6 — Typical chemical composition and mechanical properties of welding consumables for 9Cr-1Mo-V-Nb steel (e.g. ASTM A387 Gr. 91 Cl. 2) for ultra-supercritical pressure boilers

Welding process	Brand name ⁽¹⁾	AWS Class.	Typical chemical composition (%) ⁽²⁾									
			C	Mn	Si	P	S	Cr	Mo	Ni	Nb	V
SMAW (DCEP)	CM-95B9	A5.5:2014 E9015-B91	0.10	0.89	0.26	0.01	< 0.01	9.1	1.04	0.45	0.04	0.22
	CM-96B9	A5.5:2014 E9016-B91	0.10	0.88	0.27	0.01	< 0.01	9.0	1.06	0.44	0.04	0.22
GTAW (DCEN)	TG-S90B9	A5.28:2005 ER90S-B9	0.11	0.75	0.26	0.006	0.004	9.30	1.00	0.47	0.06	0.20
SAW (DCEP)	PF-90B9 US-90B9	A5.23:2011 F9PZ-EB91-B91	0.10	0.92	0.21	0.009	0.004	9.00	0.97	0.50	0.04	0.21

Welding process	Brand name ⁽¹⁾	AWS Class.	Typical mechanical properties of weld metal				PWHT (°C × hr)
			Tensile strength (MPa)	0.2% proof strength (MPa)	Elongation (%)	Charpy impact energy (J)	
SMAW (DCEP)	CM-95B9	A5.5:2014 E9015-B91	768	651	22	74 at 20°C	760 × 2
	CM-96B9	A5.5:2014 E9016-B91	771	657	21	71 at 20°C	760 × 2
GTAW (DCEN)	TG-S90B9	A5.282005 ER90S-B9	809	706	22	160 at 0°C	760 × 2
SAW (DCEP)	PF-90B9 US-90B9	A5.23:2011 F9PZ-EB91-B91	716	582	23	37 at 20°C	760 × 2

Note: (1) Trade designations of filler metals produced by Kobe Steel.

(2) The chemical composition of the weld metal for SMAW and SAW and of the wire for GTAW.

3.3 Selection guide for proper welding consumables

In selecting a proper welding consumable for joining similar Cr-Mo steels, the following basic properties should be taken into account in addition to general factors such as applicable welding positions, available welding equipment, and permissible welding costs.

- (1) The weld metal should contain almost the same percentage of main alloying elements such as chromium and molybdenum as the base metal to be welded. This is because chromium and molybdenum are the fundamental elements in terms of corrosion or oxidation resistibility and creep-rupture strength respectively for high-temperature uses.
- (2) The weld metal should have adequate mechanical properties (tensile strength, 0.2% proof strength, ductility, and notch toughness) to the minimum requirements after specified postweld heat treatment. This is to ensure the weld joint strength at specified service temperatures.

When joining dissimilar metals, the weld metal should match the lower-alloy metal, the higher-alloy metal, or the intermediate depending on the application. However, normally, the weld metal need not be stronger or more resistant to creep and corrosion than the lower-alloy metal; therefore, a filler metal matching the lower-alloy metal is commonly used, as shown in **Table 3.7**. Type 309 austenitic stainless steel and some high-nickel alloy filler metals should be selected to join Cr-Mo steels to austenitic stainless steels, as shown in Table 3.7.

Table 3.7 — A selection guide for welding consumables for joining dissimilar metals (SMAW, GTAW)

Base metal	Mild steel	0.5Mo	1.25Cr-0.5Mo	2.25Cr-1Mo	5Cr-0.5Mo	9Cr-1Mo
Type 304 stainless steel	<ul style="list-style-type: none"> •NC-39 (E309), NC-39L (E309L), TG-S309 (ER309), TG-S309L (ER309L) •NI-C703D (ENiCrFe-3), NI-C70A (ENiCrFe-1), TG-S70NCb (ERNiCr-3) 					
9Cr-1Mo	LB-52 (E7016) TG-S50 (ER70S-G)	CM-A76 (E7016-A1) TG-SM (ER80S-G)	CM-A96 (E8016-B2) TG-S1CM (ER80S-G)	CM-A106 (E9016-B3) TG-S2CM (ER90S-G)	CM-5 (E8016-B6) TG-S5CM (ER80S-B6)	
5Cr-0.5Mo	LB-52 (E7016) TG-S50 (ER70S-G)	CM-A76 (E7016-A1) TG-SM (ER80S-G)	CM-A96 (E8016-B2) TG-S1CM (ER80S-G)	CM-A106 (E9016-B3) TG-S2CM (ER90S-G)		
2.25Cr-1Mo	LB-52 (E7016) TG-S50 (ER70S-G)	CM-A76 (E7016-A1) TG-SM (ER80S-G)	CM-A96 (E8016-B2) TG-S1CM (ER80S-G)	Note: (1) This is general recommendation for the proper welding consumable matching the lower-alloy steel in a dissimilar metal joint, excepting for Type 304 steel. Other types of welding consumables may have to be selected depending on a specific requirement.		
1.25Cr-0.5Mo	LB-52 (E7016) TG-S50 (ER70S-G)	CM-A76 (E7016-A1) TG-SM (ER80S-G)				
0.5Mo	LB-52 (E7016) TG-S50 (ER70S-G)					

Note: (2) Preheating and postweld heat treatment for Cr-Mo steels should be sufficient to the higher-alloy steel. However, the PWHT temperature should be lower to avoid damage to the lower-alloy steel and to minimize the carbon migration. Type 304 stainless steel should not be preheated or postweld heat-treated to avoid sensitization.

Note: (3) Type 309 or 309L filler metals are suitable for non-cyclical temperature service below 315°C. The Ni-alloy filler metals are suitable for cyclical temperature services above 315°C, or wherever postweld heat treatment is applied, to minimize thermal stresses and carbon migration.

4. Essential factors for quality control in welding

4.1 Preparation of welding grooves

Welding grooves should be wide enough to avoid welding defects, narrow enough to minimize the welding costs, and properly balanced between the backing side and the final side to minimize welding distortion. The groove shape for butt welding is designed to be square, single-V, double-V, single-U, and double-U in this order as the plate thickness increases, in order to minimize the cross section of the groove, thereby reducing the welding costs. **Fig. 4.1** shows a comparison on the cross sectional area of groove between three different shapes of grooves as a function of plate thickness, which obviously shows the U groove is beneficial in decreasing the cross section or the mass of weld metal for thicker base metals.

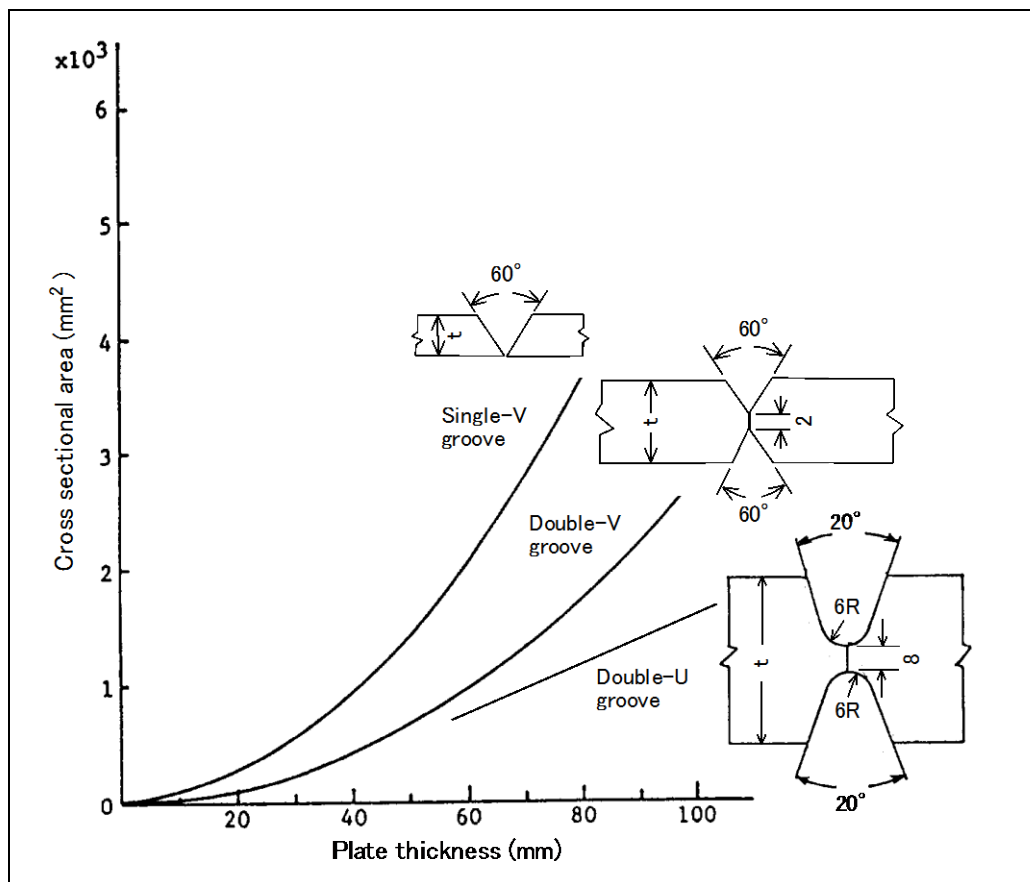

Fig. 4.1 — A comparison on the cross section of groove between three different shapes of groove as a function of plate thickness

Welding distortion can be affected by groove design when the welding process, welding procedure, joint restraint, base metal and filler metal are kept constant. **Fig. 4.2** shows the groove design most suitable for minimizing angular changes in butt joints of various thicknesses. The two curves in the figure are shown for weldments with and without strongbacks. This figure suggests that the proper groove design vary with plate thickness when the other factors are kept constant. As plate thickness increases over approximately 32 mm, the mass of the backing pass groove should be less than that of the finishing pass groove.

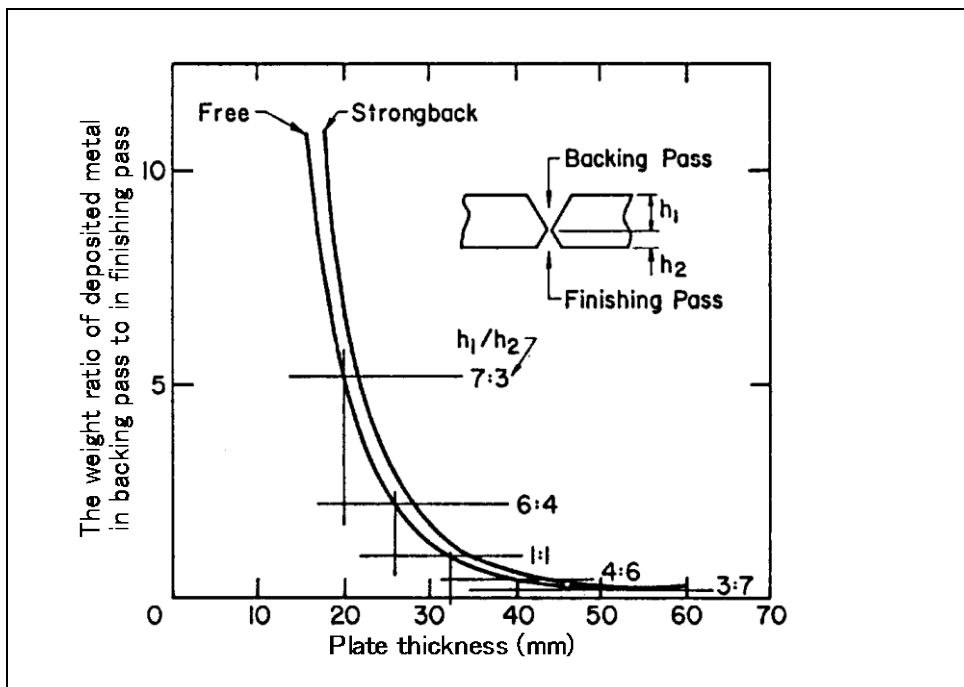

Fig. 4.2 — Proper groove design for minimizing angular change in butt welding with or without strongbacks (Source: AWS Welding Handbook)

Fig. 4.3 shows an example of groove design for submerged arc welding of heavy section plates of Cr-Mo steel. A welding groove must be free from scale, rust, oil, moisture and dirt because they can cause porosity, inclusions and cracks. Before welding heavy-section pressure vessels, the groove faces are often inspected by means of magnetic particle test to ensure that the groove surfaces contain no defects such as lamination and sulfur segregation, as shown in **Photo 4.1**.

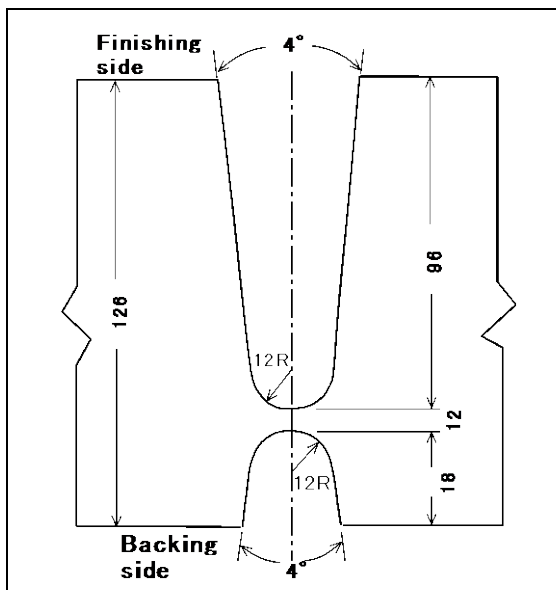

Fig. 4.3 — A groove design of a heavy section joint for submerged arc welding



Photo 4.1 — Magnetic particle testing of the bevel surface of a welding joint with a heavy section

4.2 Redrying of welding consumables

Welding consumables should be stored in a well-ventilated storehouse in order to protect them from moisture. Covered electrodes for shielded metal arc welding and fluxes for submerged arc welding should be redried before use, in order to minimize hydrogen dissolution into the weld metal and maintain good usability of the welding consumables. Redrying temperature and time depend on the type of covered electrode and flux; therefore, the drying conditions should be in accordance with supplier specifications for the welding consumables.

4.3 Gas shielding

Good gas shielding requires proper flow rates of shielding gas, appropriate nozzle standoff and protection against wind. **Table 4.1** shows a recommendation for such factors. When a wind velocity exceeds the limit, a windscreen should be used to prevent porosity in the weld metal.

Table 4.1 — A recommendation for proper gas shielding

Welding process	Shielding gas flow rate (liter/min)	Nozzle standoff (mm)	Wind velocity limitation (m/sec)
GMAW	20-25	20	2 max
GTAW	10-15	—	1 max

4.4 Flux-burden height

In submerged arc welding, an excessive flux-burden height can cause an irregular weld bead; inversely, an insufficient flux-burden height can cause porosity because nitrogen and oxygen in the air enter the molten pool. The proper flux-burden height depends on the type of flux, size of flux, shape of welding groove, welding amperage, arc voltage, and carriage speed; however, approximate flux-burden heights are 25-35 mm for single electrode method, and 30-45 mm for tandem electrode method. **Fig. 4.4** shows the flux-burden height.

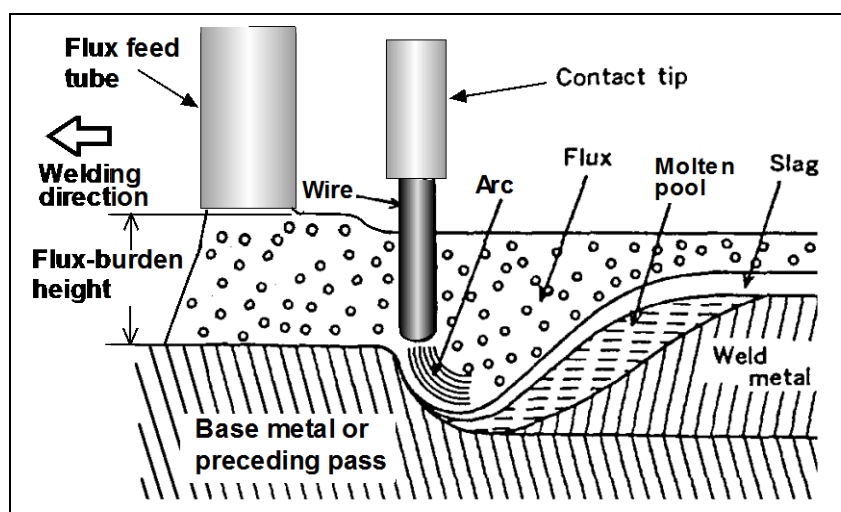

Fig. 4.4 — Flux-burden height in submerged arc welding

4.5 Preheat and interpass temperatures

For preventing cold cracking, preheat and interpass temperatures should be determined according to the thickness and carbon equivalent of base metals, joint restraint, welding process, type of welding consumable, and welding conditions. ASME Sec. VIII Div. 1(1998), for instance, provides general guidance in Appendix R — not mandatory requirements — for the preheating temperature in relation to the chemistry, tensile strength, and thickness of steel materials. For more practical guidance, **Table 4.2** shows Kobe Steel’s recommended preheat and interpass temperatures from the viewpoint of preventing the occurrence of cold cracks in the welds. In general, preheating should be carried out so that the surface area of 50-100mm wide (or three times the plate thickness) on both sides of the welding joint is raised at the specified temperature.

Table 4.2 — Kobe Steel’s recommended preheat and interpass temperatures for heat-resistant low-alloy steels

Type of steel	Preheat and interpass temperatures (°C)
Mn-Mo-Ni	150-250
0.5Mo, 0.5Cr-0.5Mo	100-250
1~1.25Cr-0.5Mo	150-300
2.25Cr-1Mo	200-350
5Cr-0.5Mo, 9Cr-1Mo	250-350
9Cr-1Mo-V-Nb	250-350
9~12Cr-W-V-Nb	250-350

Note: Exact temperature requirement varies depending on various factors such as the chemistry and thickness of the base metal to be welded as well as the welding process to be employed.

4.6 Postweld heat treatment

Postweld heat treatment (PWHT) of welds should be carried out soon after welding was finished while the preheating temperature is still maintained in the weldment to prevent delayed cracking. In cases where it is difficult to follow this procedure on completion of welding, immediate postheating (IPH) at a temperature around 300°C should be applied on the weld before it cools down to the room temperature. The IPH can remove diffusible hydrogen in the weld and thereby prevent delayed cracking. **Table 4.3** shows Kobe Steel’s recommended postweld heat treatment temperatures for weldments of heat-resistant low-alloy steel from the standpoint of obtaining good mechanical properties of weld metal. These temperatures should be maintained during the heat treatment for the appropriate hours predetermined according to the plate thickness in general. **Table 4.4** shows how to determine the holding time as per ASME Sec. VIII Div. 1(1998).

Table 4.3 — Kobe Steel's recommended postweld heat treatment temperatures for weld metals of heat-resistant low-alloy steel

Type of steel	Postweld heat treatment ⁽¹⁾ temperatures (°C)
Mn-Mo-Ni	590-650
0.5Mo, 0.5Cr-0.5Mo	620-680
1~1.25Cr-0.5Mo	650-700
2.25Cr-1Mo	680-730
5Cr-0.5Mo, 9Cr-1Mo	710-780
9Cr-1Mo-V-Nb	710-760 ⁽²⁾ , 750-800 ⁽³⁾
9~12Cr-W-V-Nb	750-800

Note: (1) Exact temperature should be determined in consideration of the characteristics of the base metal to be used
 (2) For CM-9Cb, MG-9Cb, TG-S9Cb, and PF-200S/US-9Cb
 (3) For CM-95B9, CM-96B9, TG-S90B9, and PF-90B9/US-90B9

Table 4.4 — Code requirements for holding time in PWHT (ASME Sec. VIII Div. 1:1998)

Type of steel	Minimum holding time at normal temperature for nominal thickness of weld		
	Nominal thickness of weld		
	Up to 50.8 mm	Over 50.8 to 127mm	Over 127mm
C-0.5Mo	1 hour per 25.4 mm (Minimum 15 min)	2 hours plus 15 min for each additional 25.4 mm over 50.8 mm	2 hours plus 15 min for each additional 25.4 mm over 50.8 mm
1.25Cr-0.5Mo 2.25Cr-1Mo 5Cr-0.5Mo 9Cr-1Mo-V	1 hour per 25.4 mm (Minimum 15 min)	1 hour per 25.4 mm	5 hours plus 15 min for each additional 25.4 mm over 127 mm

Note: Nominal thickness is the thickness of the welded joint as defined below:

- (a) When the welded joint connects parts of the same thickness, using a full penetration butt weld, the nominal thickness is the total depth of the weld exclusive of any permitted weld reinforcement.
- (b) For groove welds, the nominal thickness is the depth of the groove.
- (c) For fillet welds, the nominal thickness is the throat dimension. If a fillet weld is used in conjunction with a groove weld, the nominal thickness is the depth of the groove or the throat dimension, whichever is greater.
- (d) For repairs, the nominal thickness is the depth of the repair weld.

Arc Welding of Stainless Steel

Contents

1. Types and features of stainless steels	3-2
2. Metallurgical properties and weldability of austenitic stainless steels	3-4
2.1 Welding distortion	3-4
2.2 Hot cracks	3-4
2.3 Corrosion resistance	3-10
2.4 Mechanical properties of welds	3-17
3. Metallurgical properties and weldability of iron-chromium stainless steels	3-22
3.1 Martensitic stainless steel	3-22
3.2 Ferritic stainless steel	3-25
3.3 Delayed cracking	3-27
4. Clad and dissimilar metals	3-30
4.1 Welding considerations	3-30
4.2 Service considerations	3-35
4.3 Welding procedures and welding consumables	3-38
5. Metallurgical properties and weldability of specialty stainless steels	3-44
5.1 Duplex stainless steel	3-44
5.2 High-nitrogen stainless steel	3-51
5.3 High-purity ferritic stainless steel	3-54
5.4 Precipitation-hardening stainless steel	3-55

1. Types and features of stainless steels

Stainless steel possesses superior resistance to corrosion and high temperature oxidation. It also has good workability as well as excellent mechanical properties at both low and elevated temperatures. Owing to these advantages, stainless steels are used in various applications such as kitchen utensils, tableware, industrial machinery (for food processing, petroleum refinery, textile, fossil power, and nuclear power), building materials, and automobile components.

Stainless steels are alloy steels with nominal chromium contents of at least 11 percent, with or without other alloy additions. The stainless and corrosion resistance of these alloy steels are attributed to the presence of a passive oxide film on the surface. This chapter divides stainless steels into common grades and specialty grades. The three common grades are austenitic, martensitic, and ferritic. Four specialty grades are duplex, high-nitrogen, high-purity ferritic, and precipitation-hardening. The major alloying elements that affect the metallurgical characteristics are chromium, nickel, and carbon. Other alloying elements, such as molybdenum, niobium, titanium, manganese, nitrogen, and copper, also contribute to the metallurgical characteristics of the stainless steels. The common-grade wrought stainless steels are classified and assigned designations according to chemical composition. **Table 1.1** shows the classification series for the three common-grade wrought stainless steels classified by the American Iron and Steel Institute (AISI).

Table 1.1 — Classifications of common-grade wrought stainless steels

AISI classification series	Alloy type	Metallurgical phase
2XX	Cr-Ni-Mn	Austenitic
3XX	Cr-Ni	Austenitic
4XX	Cr	Martensitic
		Ferritic

The typical physical properties of various common grades of stainless steels are given in **Table 1.2**, including those of carbon steel for comparison. Thermal expansion, thermal conductivity, and electrical resistivity have significant effects on the weldability of stainless steels.

Table 1.2 — Typical physical properties of common grades of stainless steels in comparison with carbon steel

Type of steel	Specific gravity	Electrical resistivity ($\mu \Omega \cdot \text{cm}$)	Magnetism at room temp.	Specific heat at 0 -100°C (cal/g · °C)	Linear expansion coefficient at 0 -100°C ($10^{-6}/\text{°C}$)	Thermal conductivity at 100°C ($10^{-2} \text{cal/cm/sec} \cdot \text{°C}$)
Carbon steel	7.86	15	Magnetic	0.12	11.4	11.2
Austenitic stainless steel (Type 304)	7.93	72	Non-magnetic	0.12	17.3	3.89
Martensitic stainless steel (Type 410)	7.75	57	Magnetic	0.11	9.9	5.95
Ferritic stainless steel (Type 430)	7.70	60	Magnetic	0.11	10.4	6.24

The compositions of commonly utilized wrought stainless steels are provided in **Table 1.3**. The austenitic stainless steels are based on the Fe-Cr-Ni ternary system. Chromium provides the oxidation and corrosion resistance to temperatures approaching 649 °C in various environments. Nickel and manganese are added to stabilize the austenitic phase. These steels are generally fully austenitic, although some high-temperature ferrite (delta ferrite) may be retained in the structure. The addition of nitrogen, denoted by the suffix N, increases the strength of steel and the stability of austenite. The high carbon content of some types, denoted by the suffix H, is controlled between specific levels for high-temperature strength. Low-carbon variations are denoted by the suffix L. Austenitic stainless steels make up about two-thirds of all stainless steels production because of their combination of high formability and good corrosion resistance. Food-handling equipment, chemical process equipment, pulp and paper equipment, cryogenic vessels, railway cars, heat treating equipment, heat exchangers, combustion chambers, and gas turbine components are typical applications for austenitic stainless steels.

Martensitic stainless steels are essentially Fe-Cr-C alloys with nominally 11.5-18% chromium. The most widely used martensitic stainless steel is Type 410, which is used for machine parts, cutlery, hardware, and engine components. A typical application for Type 403 is turbine blades.

Ferritic stainless steels are Fe-Cr-C alloys with sufficient chromium or chromium plus other ferrite stabilizer such as aluminum, niobium, molybdenum, and titanium. Ferritic stainless steels offer more stable performance when subjected to cyclical heating and thermal shock. Type 430, therefore, is widely used for such applications as furnaces, heater components, and automotive exhaust systems. The clad plate used on the internal surfaces of a coke drum is a typical application for Type 405.

Table 1.3 — Main chemical compositions of various wrought stainless steels (wt.%)⁽¹⁾

Type of phase	AISI grade	C	Mn	Si	Cr	Ni	Others
Austenitic	201	0.15	5.50-7.50	1.00	16.00-18.00	3.50-5.50	0.25N
	302	0.15	2.00	1.00	17.00-19.00	8.00-10.00	—
	304	0.08	2.00	1.00	18.00-20.00	8.00-10.50	—
	304H	0.04-0.10	2.00	1.00	18.00-20.00	8.00-11.00	—
	304L	0.03	2.00	1.00	18.00-20.00	8.00-12.00	—
	304LN	0.03	2.00	1.00	18.00-20.00	8.00-12.00	0.10-0.16N
	304N	0.08	2.00	1.00	18.00-20.00	8.00-10.50	0.10-0.16N
	309S	0.08	2.00	1.00	22.00-24.00	12.00-15.00	—
	310S	0.08	2.00	1.50	24.00-26.00	19.00-22.00	—
	316	0.08	2.00	1.00	16.00-18.00	10.00-14.00	2.00-3.00Mo
	316H	0.04-0.10	2.00	1.00	16.00-18.00	10.00-14.00	2.00-3.00Mo
	316L	0.030	2.00	1.00	16.00-18.00	10.00-14.00	2.00-3.00Mo
	317	0.08	2.00	1.00	18.00-20.00	11.00-15.00	3.00-4.00Mo
	317L	0.03	2.00	1.00	18.00-20.00	11.00-15.00	3.00-4.00Mo
321	0.08	2.00	1.00	17.00-19.00	9.00-12.00	5x%C:Ti min.	
347	0.08	2.00	1.00	17.00-19.00	9.00-13.00	10x%C:Nb min.	
Martensitic	403	0.15	1.00	0.50	11.50-13.00	—	—
	410	0.15	1.00	1.00	11.50-13.50	—	—
Ferritic	405	0.08	1.00	1.00	11.50-14.50	—	0.10-0.30Al
	430	0.12	1.00	1.00	16.00-18.00	—	—

Note (1): Single values are maximum. (Source: CASTI, The Metals Black Book)

2. Metallurgical properties and weldability of austenitic stainless steels

Austenitic stainless steels can readily be welded. However, careless welding may cause degradation of the base metal and defective weldments. The major problems to which we should pay attention in planning the welding procedure are

- (1) Welding distortion
- (2) Hot cracks
- (3) Intergranular corrosion
- (4) Stress corrosion cracking

2.1 Welding distortion

Welding distortion is the non-uniform expansion and contraction of weld metal and adjacent base metal, occurred during the heating and cooling cycle of the welding process. As shown in Table 1.2, the thermal conductivity of austenitic stainless steels is approximately one-third of that of carbon steel. The thermal expansion coefficient is about 1.5 times that of carbon steel. Accordingly, the welding of austenitic stainless steel is liable to cause greater distortion. This means that preventive measures against welding distortion should be more deliberate particularly when welding sheet metals. Welding distortion can be minimized by restraining the welding joint with a jig and by cooling rapidly the weld by using a copper backing. Adopting special welding techniques such as symmetrical, stepping-stone and back-step sequence is also effective. These techniques can disperse the arc heat and, in turn, avoid a concentration of welding thermal stresses. In tack welding of stainless steel components, a smaller weld pitch should be used than in tack welding of carbon steel components. The pitch should be 20 to 50 times the thickness of the plate to be welded. As to the restraint jigs and the special welding sequences, refer to a reference textbook “The ABC’s of Arc Welding and Inspection.”

2.2 Hot cracks

Hot crack is the typical type of cracking observed in welding austenitic stainless steels, which generally occurs in the austenite grain boundaries and columnar crystal boundaries. Hot cracks occur at elevated temperatures where the weld metal changes its phase from liquid to solid. The most effective measure to prevent hot cracks is to adjust the chemical composition so that the weld metal contains a certain percentage of ferrite. Ordinary welding consumables such as Types 308, 316 and 347 are designed so that, unlike the base metal, the weld metal contains an appropriate amount of ferrite to prevent hot cracking. **Photo 2.1** shows how the ferrite precipitates in the weld metal. The presence of ferrite in the weld metal improves crack resistance at the expenses of corrosion resistance and impact toughness. Therefore, appropriate control of the ferrite content is an important matter. The effect of ferrite on hot cracking, the methods of measuring ferrite content and the influence of impurities on hot cracking are discussed in the following sections.

Photo 2.1 — Microstructures of Type 308 weld metal (left half) and Type 304 base metal (right half)

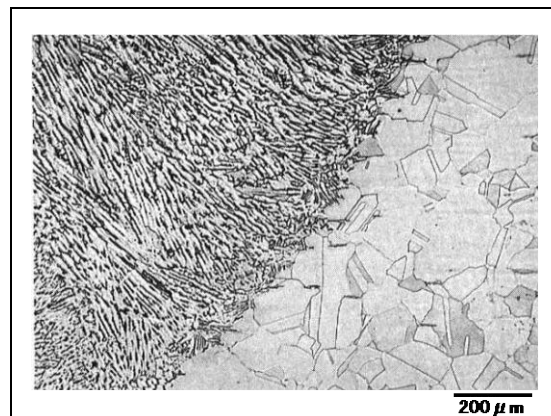

(1) Effects of ferrite

Fig. 2.1 shows the effect of ferrite content on the number of microfissures occurred in Type 308 weld metals, which reveals that the presence of ferrite in the weld metal is effective to prevent hot cracking. The 308-type weld metals are formulated so that they contain ferrite in the range 3-10FN in order to prevent hot cracking and to minimize the tendency of sigma-phase embrittlement at elevated temperatures. These filler metals are avoided only in cases where the presence of ferrite degrades impact notch toughness at cryogenic temperatures.

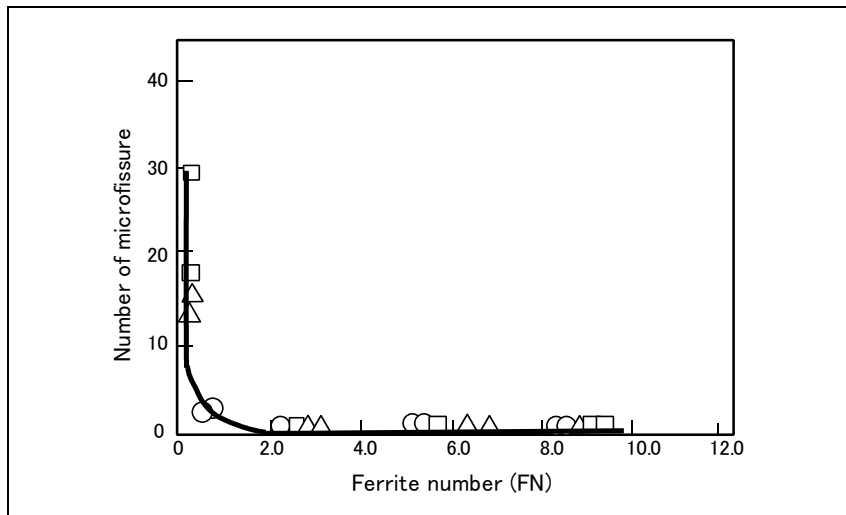

Fig. 2.1 — The number of microfissures as a function of ferrite number (FN) for E308 weld metal observed in the WRC fissure bend test

The mechanism of preventing hot cracking is commonly convinced as the following. Delta ferrite (high-temperature ferrite) will first be crystallized as shown in (C) or (D) of **Fig. 2.2** in the solidification process of austenitic stainless steel weld metal. The delta ferrite dissolves much more, than does the austenitic phase, of impurities such as phosphorus and sulfur that tend to form the intermetallic compounds of low melting points (the main causes of hot cracking), thereby decreasing the intergranular segregation of the impurities and, in turn, improving hot crack resistance. By contrast, if the austenite phase crystallizes first in the solidification process as shown in (A) or (B) of **Fig. 2.2**, the intergranular segregation of phosphorus and sulfur becomes greater causing higher crack sensitivity.

The ferrite content in weld metals can vary affected by the welding conditions. For example, a longer arc in shielded metal arc welding can cause more consumption of chromium (a ferrite-forming element) due to oxidation and more dissolution of atmospheric nitrogen (an austenite-forming element), resulting in a reduced amount of ferrite in the weld metal. In submerged arc welding featuring deeper penetration, the use of higher welding currents can reduce the ferrite content of the weld metal because of much more dilution by the base metal.

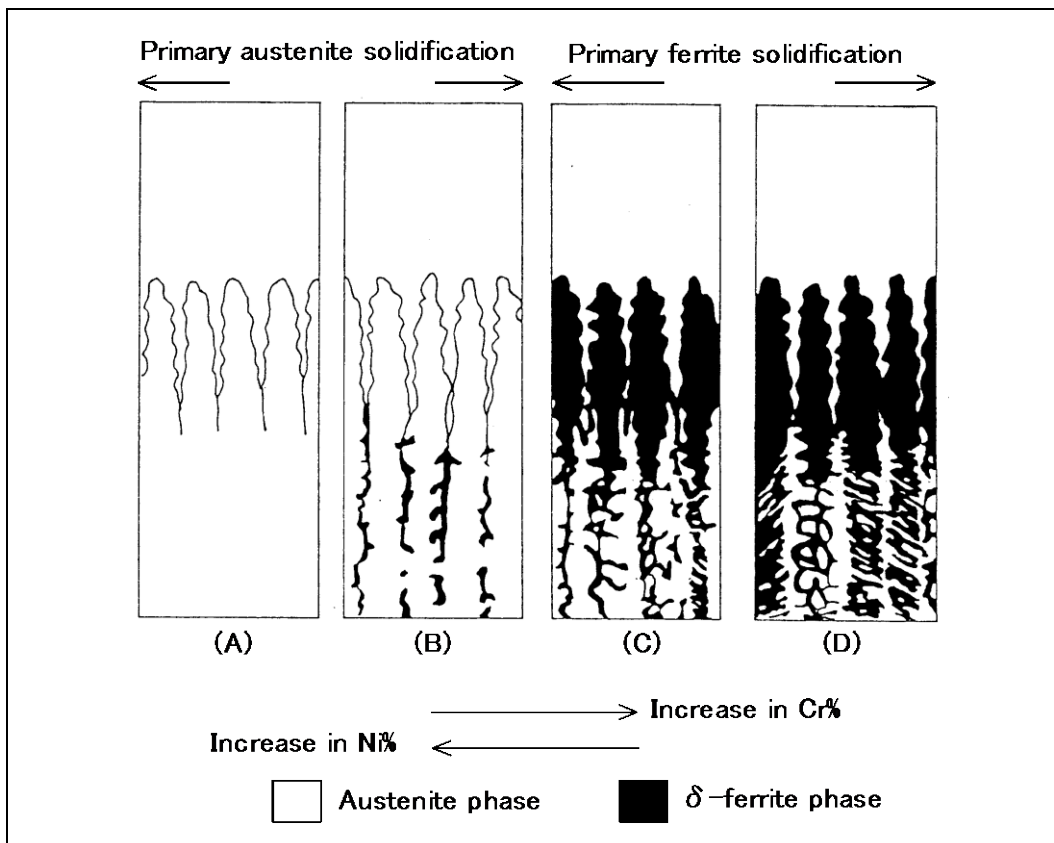

Fig. 2.2 — Schematic solidification modes of austenite and ferrite

(2) Methods for measuring ferrite content

The amount of ferrite in weld metals can be measured by the following methods:

(a) **Magnetic device:** Ferrite is ferromagnetic while austenite is non-ferromagnetic. These characteristics are used to measure the amount of ferrite in austenitic stainless steel weld metals by using a magnetic device. The magnetic devices include Ferrite Indicator (**Photo 2.2**), Magne Gage (**Photo 2.3**) and Feritscope (**Photo 2.4**).

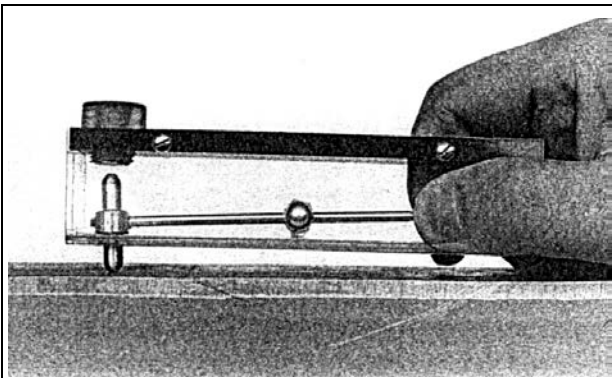

Photo 2.2 — Ferrite Indicator measures the magnetic attraction between a test surface and a standardized ferrite percent insert.

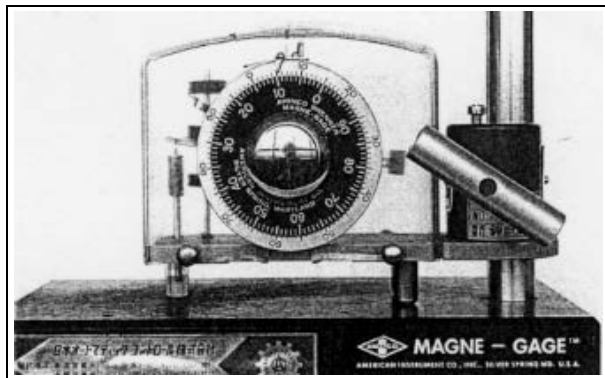

Photo 2.3 — Magne Gage measures the pull-off force necessary to detach a standardized permanent magnet from a test surface.

Photo 2.4 — Feritscope measures the voltage induced in the probe coil according to the ferrite content. This instrument is suitable for use at site because the probe is small enough to put on a small area of weld metal.



(b) **Phase diagram:** First, calculate the nickel and chromium equivalents of a weld metal in accordance with the equations given in a phase diagram, and plot it in the phase diagram to obtain the amount of ferrite of the weld metal. The phase diagrams adopted often for this purpose are the Schaeffler (Fig. 2.3), DeLong (Fig.2.4), and WRC-1992 diagrams (Fig. 2.5). The Schaeffler diagram incorporates a much wider range of compositions than either the DeLong, or WRC-1992 diagram and thus has greater utility when evaluating the weldability of a dissimilar-metal joint consisting of austenitic stainless steel and carbon or low-alloy steel. The WRC-1992 diagram has been expanded in terms of chromium equivalents to include many of the duplex stainless steel weld metals.

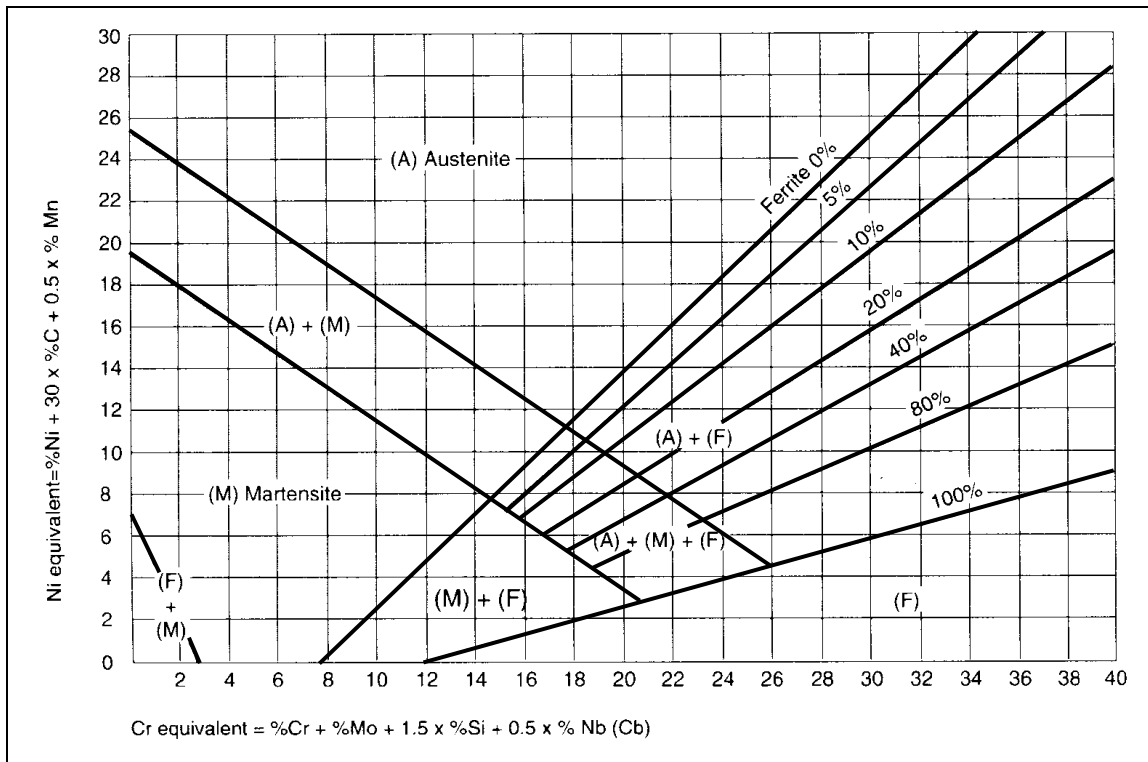

Fig. 2.3 — Schaeffler diagram

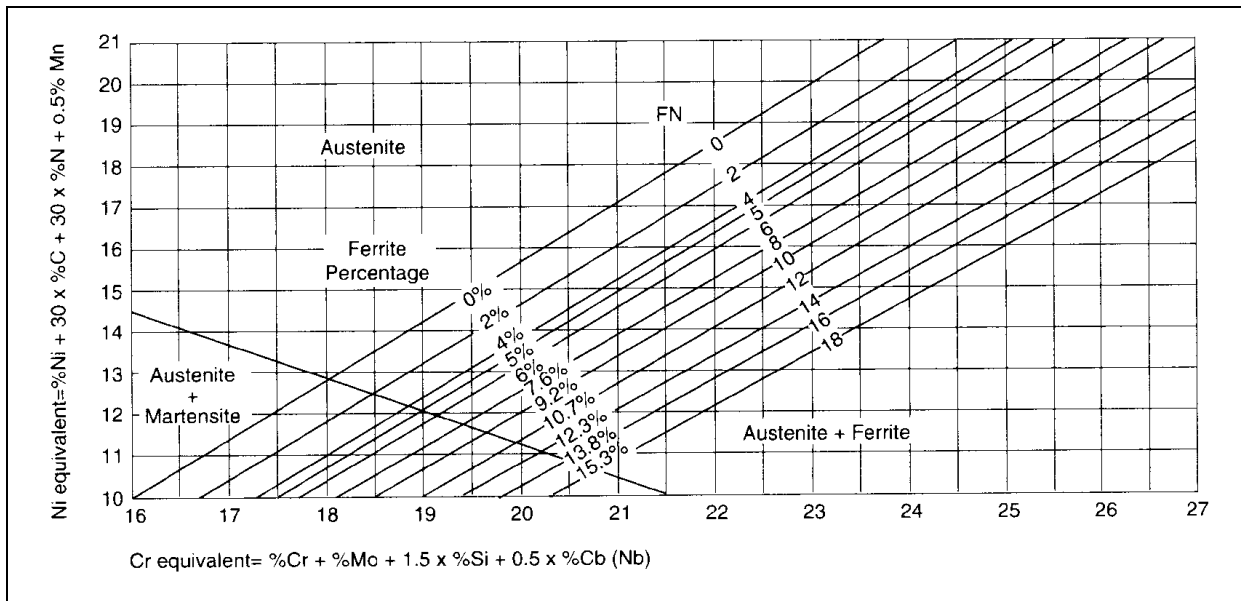

Fig. 2.4 — DeLong diagram (A chemical analysis should be used for N%, but if not available, use 0.03%)

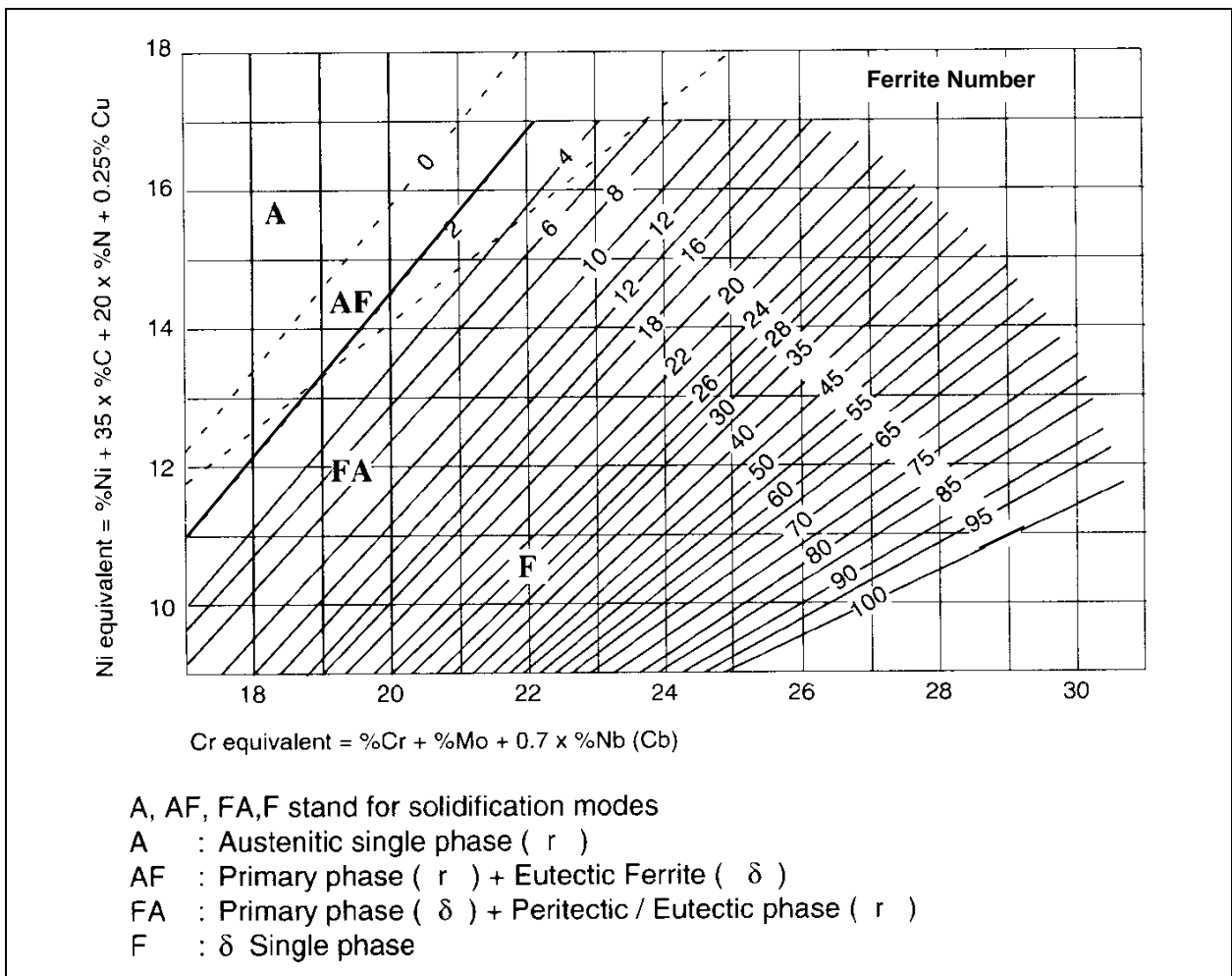

Fig. 2.5 — WRC-1992 diagram can be applied for a wide range of stainless steel weld metals including many of the duplex stainless steel weld metals.

(c) **Microscopic point counting method:** The amount of ferrite is determined by the percentage of ferrite areas in a microstructure. The ferrite area percentage is determined by the following formula: $\alpha = [n / (P \times f)] \times 100$ where α is percent ferrite; n is the total number of grid crossing points shared by ferrite phases in the views tested at f times; P is the total grid number ($20 \times 20 = 400$); f is the testing frequency (30 at least, 60 as a standard) as per JIS G 0555:2003 (Microscopic Testing Method for Non-Metallic Inclusions in Steels).

The amount of ferrite is expressed in, depending on the measuring method, either ferrite percent (%) or ferrite number (FN). It is important to note that the ferrite determination for a certain weld metal can vary for the welding procedure variables such as electrode size, welding parameters (amperage, voltage, and travel speed), welding positions, pass sequence, weaving width, and welder's skill.

(3) Influence of impurity elements

The hot crack susceptibility of weld metals is influenced by impurities such as phosphorus, sulfur and boron that are apt to form intermetallic compounds having low melting points. **Fig. 2.6** shows the influences of phosphorus and sulfur on the hot-crack susceptibility of 309-type weld metals. This figure suggests that reduction of phosphorus and sulfur can decrease the hot crack susceptibility even though the amount of ferrite is small. Type 310 and other fully austenitic welding consumables contain very low amounts of phosphorus and sulfur, and the silicon content is also low. This chemical arrangement is to restrict the formation of low-melting-point intermetallic compounds, thereby maintaining a good resistance to hot cracking. Hot crack susceptibility can also be reduced by increasing manganese that can combine with sulfur by creating a manganese sulfide (MnS).

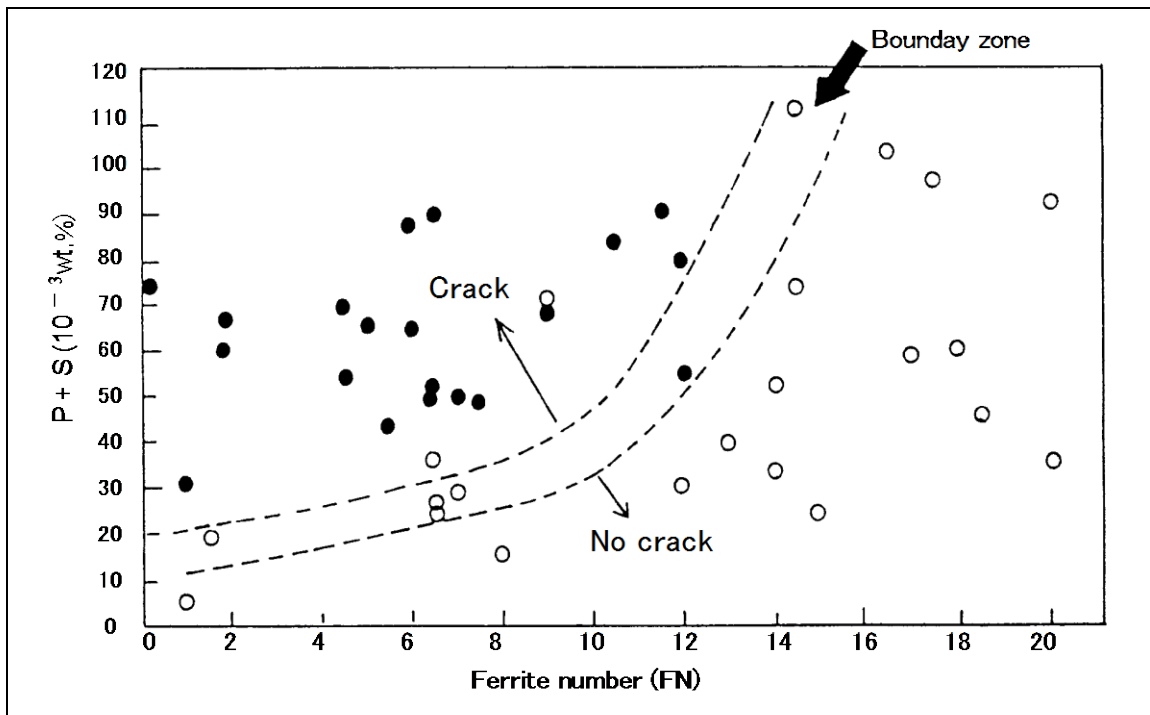

Fig. 2.6 — Effects of P+S content and ferrite number on hot crack susceptibility of Type 309 weld metals

2.3 Corrosion resistance

2.3.1 Intergranular corrosion

(1) Weld decay

Austenitic stainless steels are intentionally balanced compositionally to produce lower ferrite content and are subjected to rolling process and solid-solution heat treatment followed by rapid cooling. During cooling, the solubility of carbon decreases greatly at the temperatures below approximately 900°C. However, due to the rapid cooling, the contained carbon is supersaturated in the solid solution of stainless steel. Therefore, the stainless steels inherently have fully austenitic microstructures. In welding, however, the heat of arc activates the supersaturated carbon (unstable carbon) to combine with chromium of the base metal to form stable chromium carbides. This carbide formation reaction takes place in the austenite grain boundaries of the area (carbide-precipitation zone) heated by 500 to 800°C in the heat-affected zone (HAZ) of the base metal, as shown in **Fig. 2.7**. The area heated at temperatures over 1000°C in the HAZ, adjacent to the fusion line of the weld, is referred to as the solid-solution zone, which will be discussed later.

Chromium carbides precipitate along the grain boundaries, depleting the corrosion-resistible, uncombined chromium at or adjacent to the grain boundaries, as shown schematically in **Fig. 2.8**. The low-chromium regions along the grain boundaries are sensitive to corrosion, which can selectively be attacked in a corrosive environment. This phenomenon is called “sensitization.” The selective attack is called “weld decay.” **Photo 2.5** shows a typical weld decay occurred in a pipe.

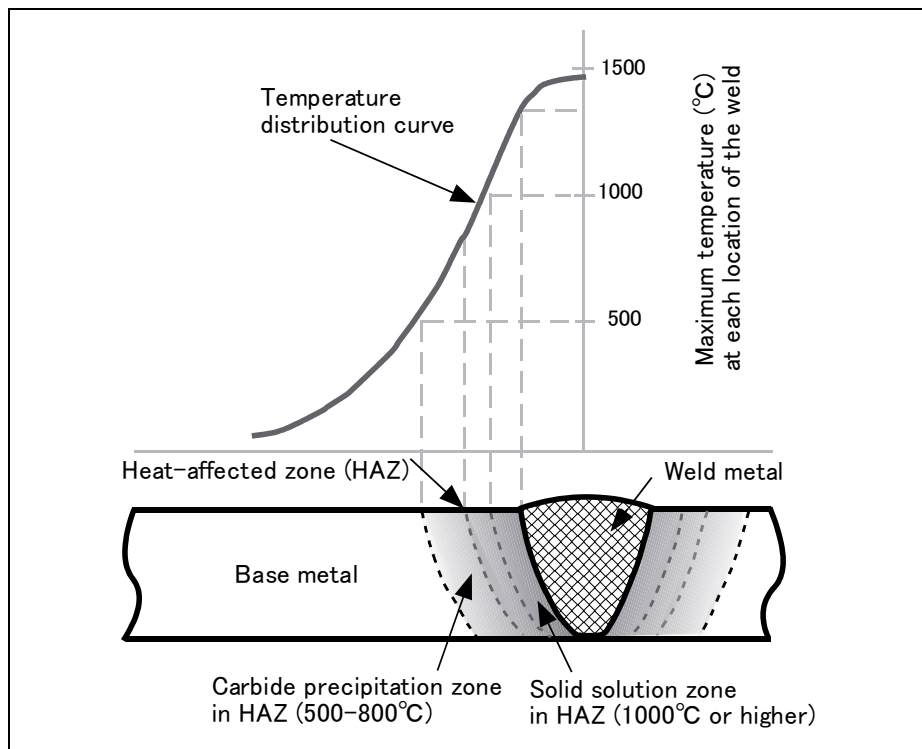

Fig. 2.7 — Temperature distribution and the heat-affected zone in a 304-type stainless steel weld

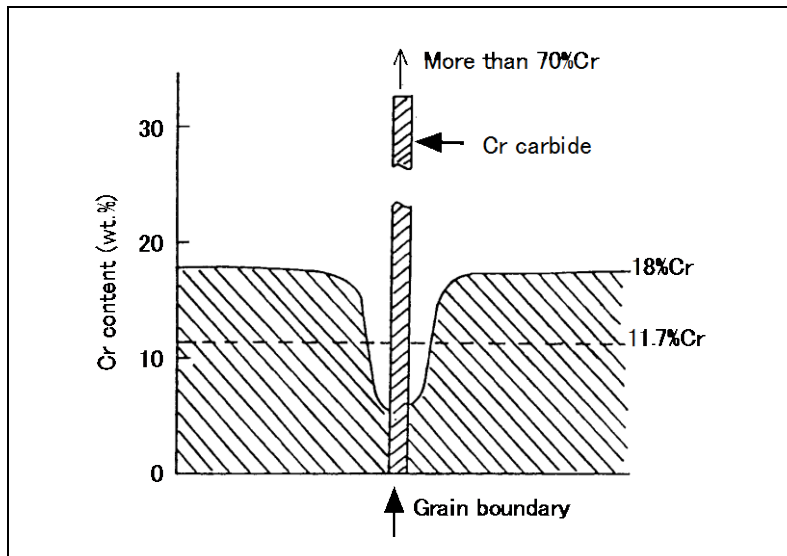

Fig. 2.8 — Distribution of Cr concentration near the grain boundary where intergranular corrosion occurs

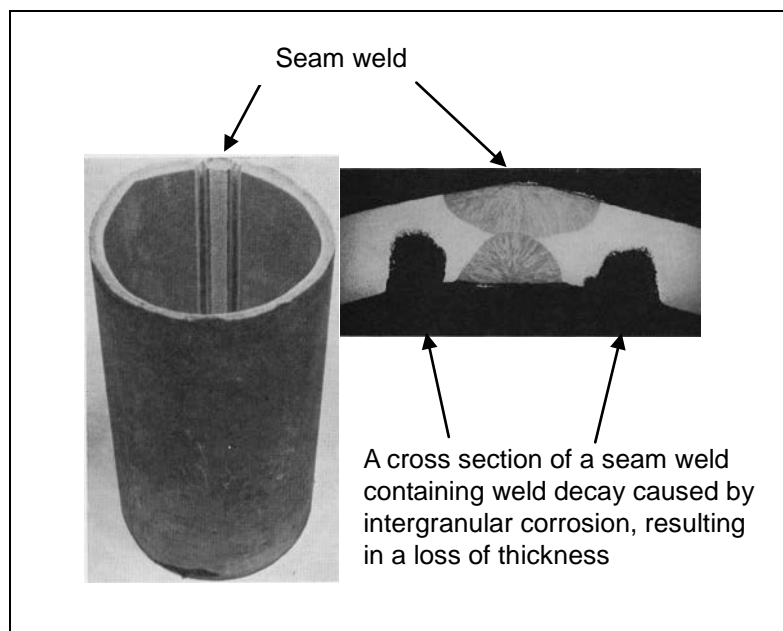

Photo 2.5 — Weld decay occurring on both sides of a 304-pipe weld for a hot dilute nitric process line (Photo source: AWS Welding Handbook)

The extent of intergranular corrosion is affected by the carbon content of the base metal, as shown in **Fig. 2.9**. Intergranular corrosion is also influenced by the heating temperature and heating time; it occurs most quickly at around 700°C. In addition, the use of high heat input increases the width of the heat-affected zone of the base metal as shown in **Fig. 2.10**, thereby increasing the extent of intergranular corrosion.

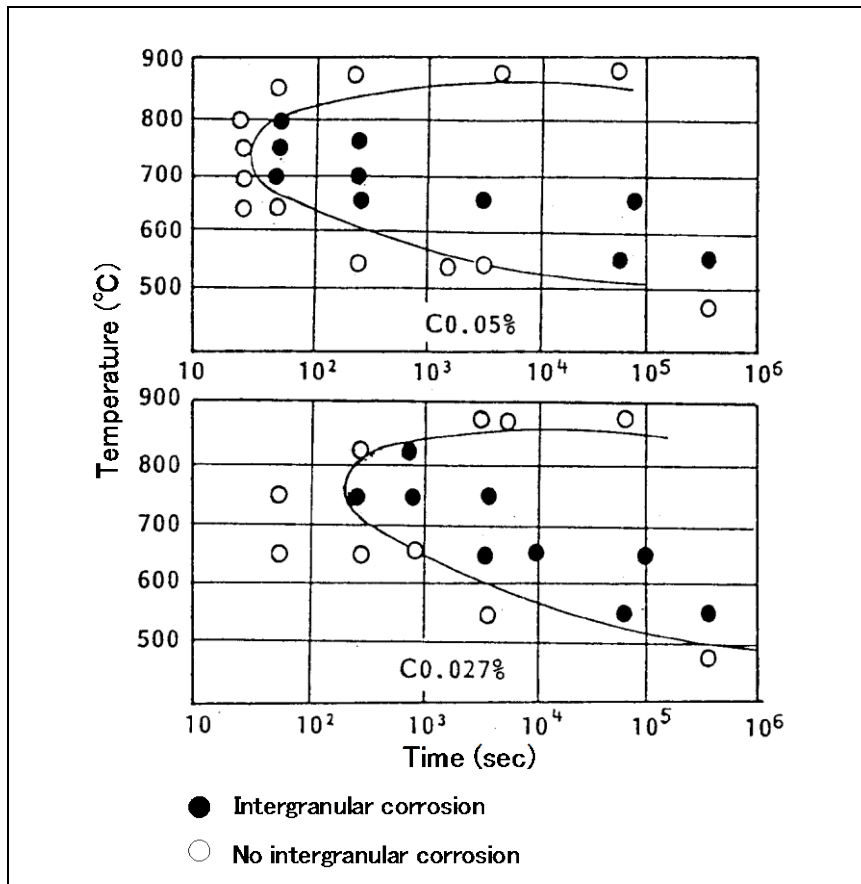

Fig. 2.9 — Effects of temperature and time on intergranular corrosion of Type 304 stainless steel

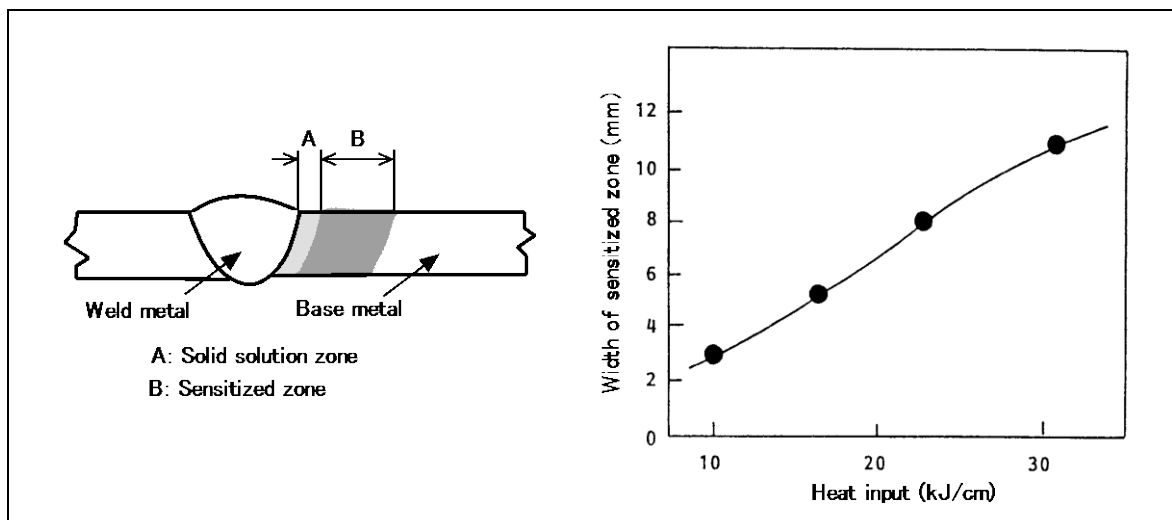

Fig. 2.10 — Effect of heat input on the width of the sensitized zone

In order to control the sensitization of the heat-affected zone, use

- (a) Postweld solution heat treatment in the temperature range of 1000 to 1150°C, followed by rapid cooling, which decomposes chromium carbides and makes chromium resistible to corrosion.
- (b) 304L or 316L low carbon type stainless steel, because lower carbon content decreases carbide precipitation.
- (c) 347 or 321 stabilized type stainless steel, because stronger carbide-forming elements (Nb or Ti) prevent the precipitation of chromium carbides.
- (d) Lower heat input or a water-cooling procedure to increase the cooling rate in the sensitizing temperature range of 500-800°C.

Unlike the base metal, austenitic stainless steel weld metals contain ferrite in distributed form. Ferrite contains higher amounts of chromium than the austenitic matrix; hence, the chromium-depleted zone is hardly formed. Accordingly, the weld metal has greater resistance to intergranular corrosion than the base metal. **Fig. 2.11** shows how the ferrite in weld metals influences intergranular corrosion. As the ferrite content increases, the sensitized zone (the temperature-time zone where intergranular corrosion occurs) becomes narrower being located at a lower-temperature longer-time zone.

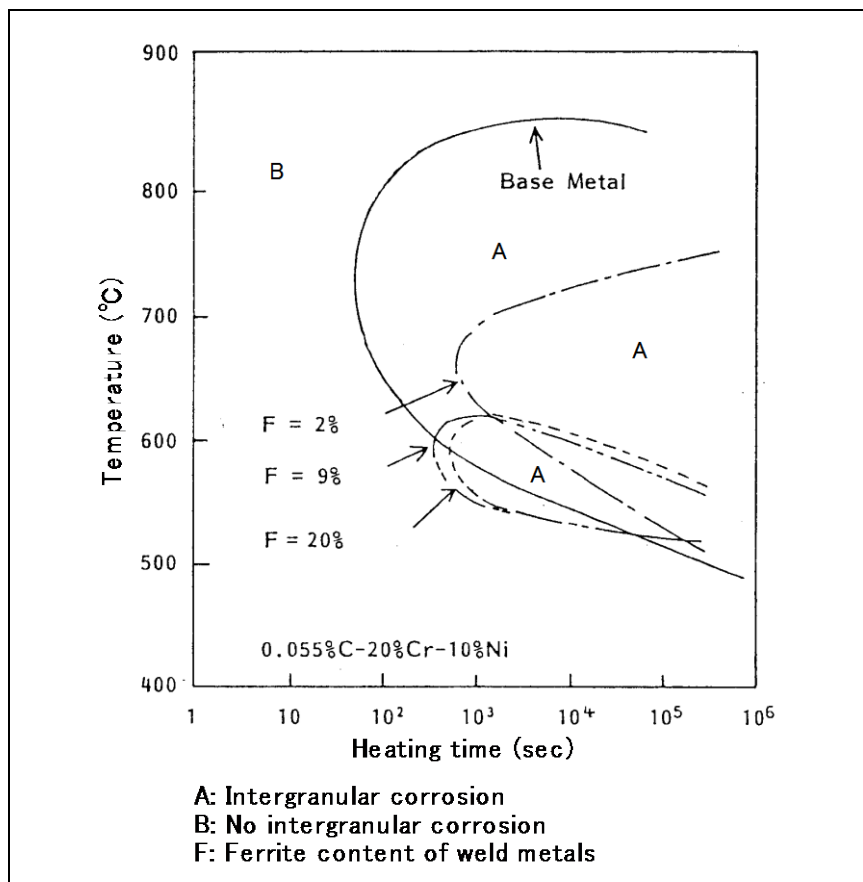

Fig. 2.11 — Effect of ferrite content on Intergranular corrosion of Type 308 weld metal in comparison with Type 304 base metal (Copper-sulfate, sulfuric-acid corrosion test)

(2) Knife line attack

In stabilized stainless steels such as Types 321 and 347, the carbon is fixed by titanium and niobium respectively to form stable carbides of TiC and NbC respectively and so no weld decay occurs in the heat-affected zone of the base metal. However, when the weld is subject to either postweld heat treatment by 600 to 650°C or services in this temperature range, its solid solution zone (**Fig. 2.12**) will be sensitized, thereby causing a knife-line attack (intergranular corrosion) in a corrosive environment. The knife-line attack is caused by the reduction in the resistance to intergranular corrosion of the solid-solution zone heated to 1000°C or higher during welding. In the solid-solution zone, TiC and NbC are dissolved to form a solid solution with the matrix; therefore, when the zone is heated by 600 to 650°C, chromium preferentially combines with the dissolved carbon to precipitate chromium carbides along the austenite grain boundaries. This reaction results in degradation of the intergranular corrosion resistance of the solid-solution zone. The knife-line attack can be prevented by the stabilizing heat treatment by 870 to 900°C after welding. This heat treatment helps the weld precipitate TiC or NbC, thereby stabilizing the dissolved carbon. As for Type 321, however, it is believed that this heat treatment is not so effective.

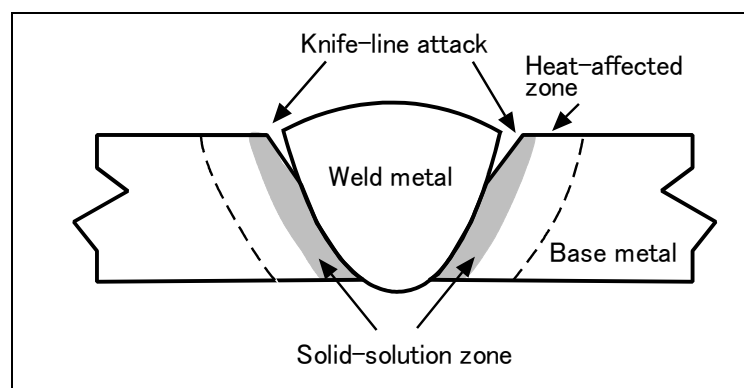

Fig. 2.12 — Schematic knife-line attack

2.3.2 Stress corrosion cracking

Stress corrosion cracking (SCC) is the biggest problem associated with the corrosion of austenitic stainless steels, for nearly half of all the corrosion damages occurred in austenitic stainless steels relate to SCC. SCC is caused by the interaction between tensile stresses and corrosives. It cannot occur if one of the two factors is absent. The tensile stresses include residual stresses (caused by machining and welding) in addition to thermal stresses and applied stresses arisen during operations. Among these stresses, the residual stress is the greatest cause to SCC. The corrosive environments that cause SCC are mostly accompanied by chlorides. SCC can be classified as transgranular type and intergranular type as shown in **Photo 2.6**. A typical distribution of residual stresses in a 304-type pipe weld is shown in **Fig. 2.13**. Once a SCC occurs in a weld, the stresses are re-distributed, and a compressive stress can change to a tensile stress as the crack propagates. In austenitic stainless steel weld metals containing ferrite, the ferrite can blocks the propagation of a SCC as shown in **Fig. 2.14**, thus SCC occurs less frequently in the weld metals than in the base metals.

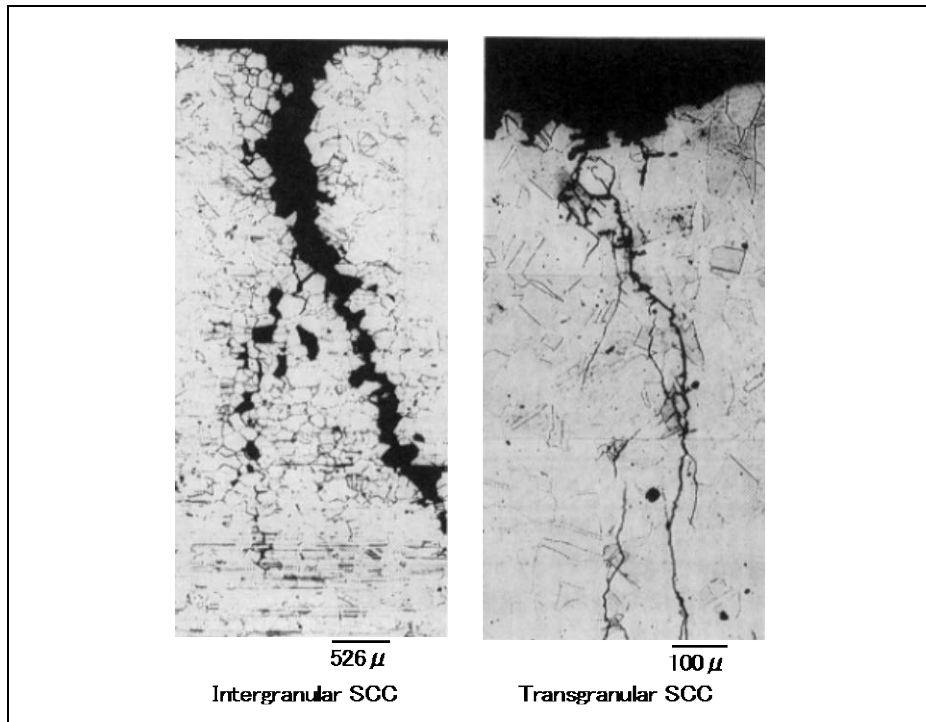

Photo 2.6 — Typical two types of stress corrosion cracking: intergranular SCC (left) and transgranular SCC (right)

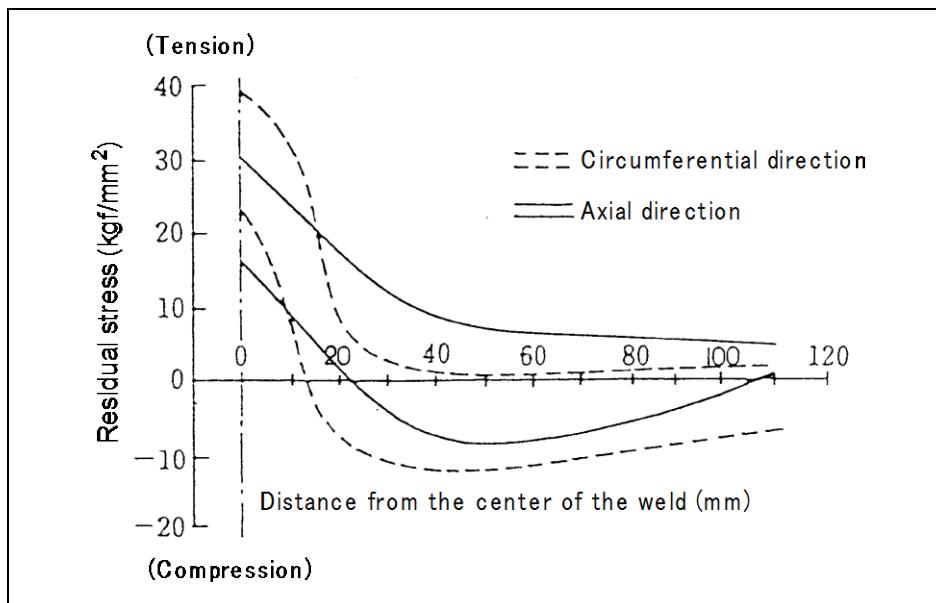

Fig. 2.13 — Distributions of residual stresses in a 304-type pipe weld (1 kgf/mm² = 9.8 MPa)

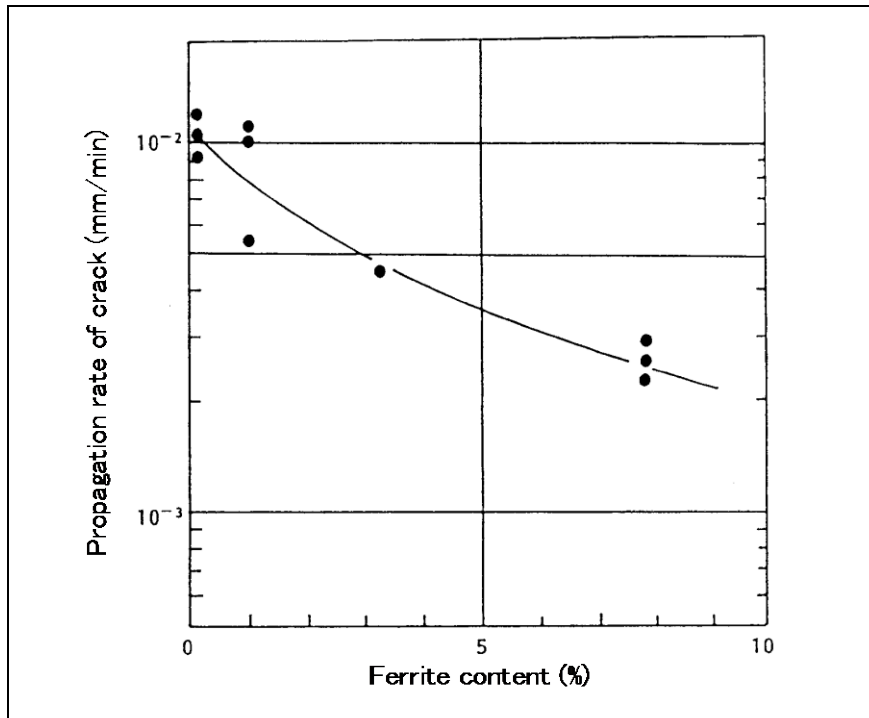

Fig. 2.14 — Effect of ferrite content on stress corrosion cracking susceptibility of a 308-type weld metal (Corrosive: 42% MgCl₂ boiling solution)

One method of relieving the residual stresses in welded joints is stress relief annealing. This method, however, is not so effective for austenitic stainless steel weldments if a stress relief annealing temperature is in the range of 600-700°C that is suitable for carbon and low alloy steels, as shown in **Table 2.1**. On the contrary, it may cause the reduction of resistance to intergranular corrosion due to precipitation of chromium carbides. Therefore, the stress relief annealing temperature should be around 900°C to relieve residual stresses effectively, avoiding the sensitization.

Table 2.1 — Effects of annealing temperatures on relieving residual stresses in stainless steel welds

Annealing temperature (°C)	Stress relieving rate (%)
500	25
600	35
700	45
800	60
900	85

2.4 Mechanical properties of welds

Austenitic stainless steel weld metals have the characteristic mechanical properties different from those of the base metal. This is because the chemical composition of the weld metal and the thermal cycle the weld metal is subjected to during welding are different when compared with the base metal. The following sections compare weld metals and base metals on mechanical properties at room temperature, elevated temperatures and low temperatures.

2.4.1 Mechanical properties at room temperature

Austenitic stainless steels have a fully austenitic structure in the range from elevated temperatures to the room temperature without transformation. Unlike carbon steel and low alloy steel, it has no quench hardenability; therefore, the hardness of the HAZ is similar to that of the base metal. At room temperature, the matching weld metals have excellent mechanical properties with high ductility and toughness. A comparison of mechanical properties between the weld metal and base metal is shown in **Table 2.2**. The weld metal has higher yield strength compared with the base metal, but the elongation and notch toughness are somewhat lower. As for tensile strength, both weld metal and base metal feature almost the same level.

Solution heat treatment, which is to improve corrosion resistance, will provide the weld metal with increases in elongation and notch toughness but with lower yield strength; consequently, the mechanical properties of the weld metal become similar to those of the base metal.

Table 2.2 — Typical mechanical properties of austenitic stainless steel base metal and weld metal at room temperature

Test sample	0.2% proof strength (MPa)	Tensile strength (MPa)	Elongation (%)	2mm-V notch Impact value (J)
Weld metal (E308)	402	578	47	74
Base metal (Type 304)	245	588	60	118

2.4.2 Mechanical properties at elevated temperatures

Offset strength and tensile strength of stainless steels at elevated temperatures decrease as the temperature increases. The elevated-temperature strength of austenitic stainless steels is far greater than that of the carbon steel as shown in **Fig. 2.15**. 316- and 347-type stainless steels have higher elevated-temperature strengths as compared with Type 304. **Fig. 2.16** shows a comparison between the weld metal (E308) and the base metal (Type 304) on elevated-temperature strength and elongation. As shown in the figure, both specimens feature almost the same tensile strength over the range of testing temperatures, but the weld metal has higher yield strength whereas the base metal has higher elongation. As to creep rupture properties, the welded joint, weld metal and base metal feature the similar level of strength as indicated in **Fig. 2.17**.

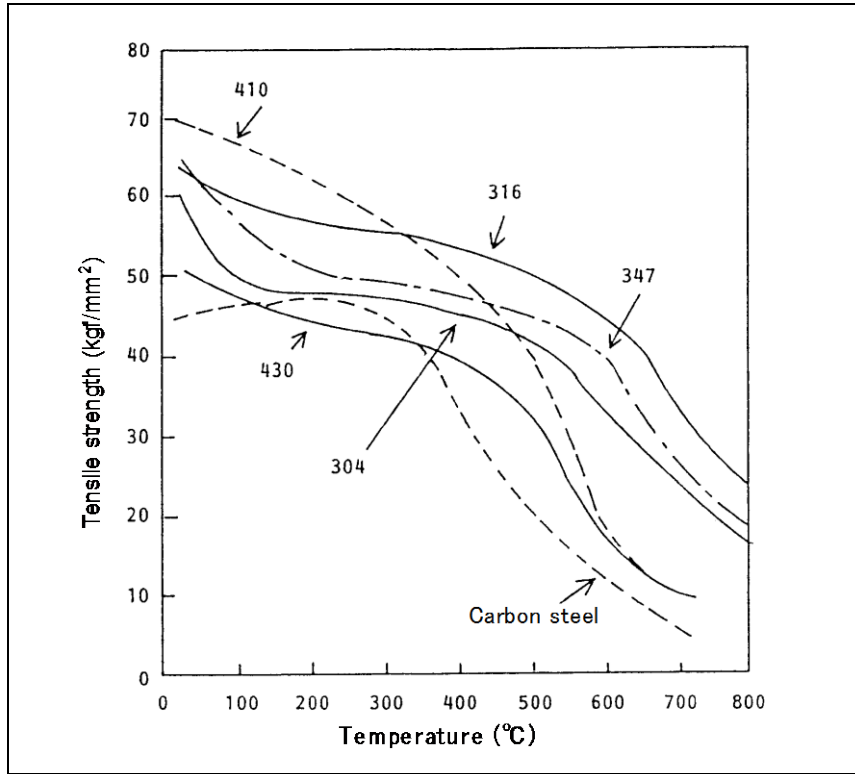

Fig. 2.15 — Tensile strength of various types of stainless steels as a function of testing temperature (1 kgf/mm² = 9.8 MPa)

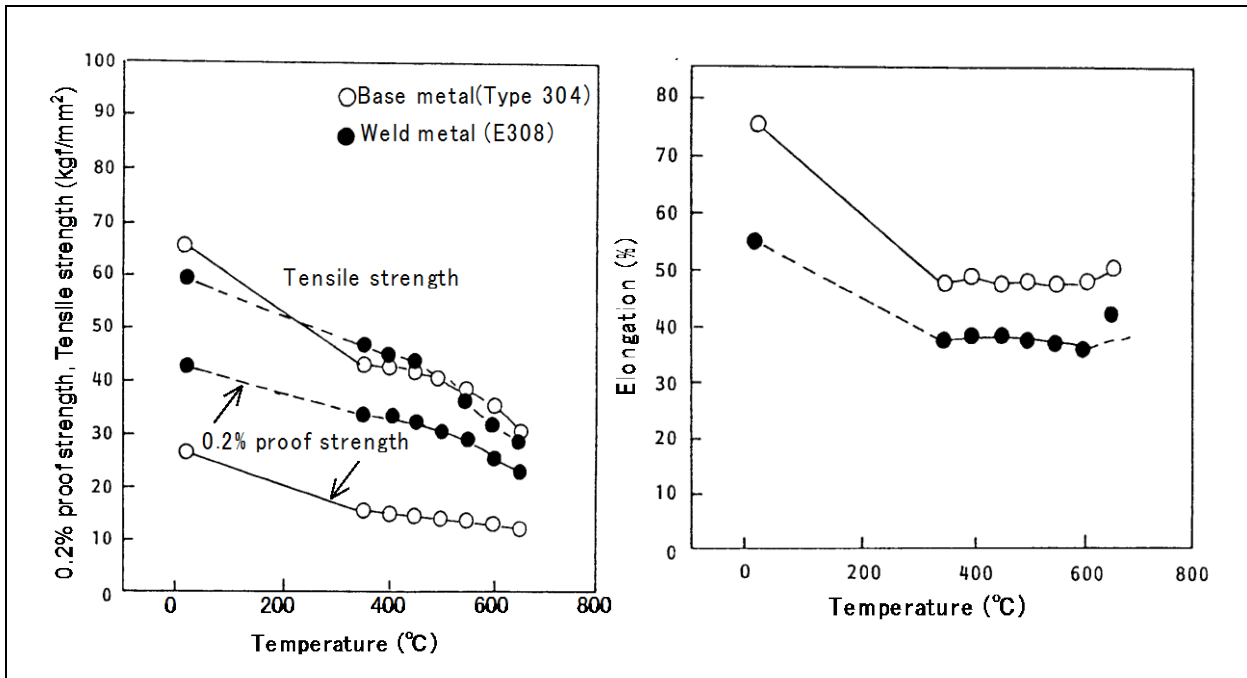

Fig. 2.16 — A comparison between 304-type steel and E308-type weld metal on tensile properties as a function of testing temperature (1 kgf/mm² = 9.8 MPa)

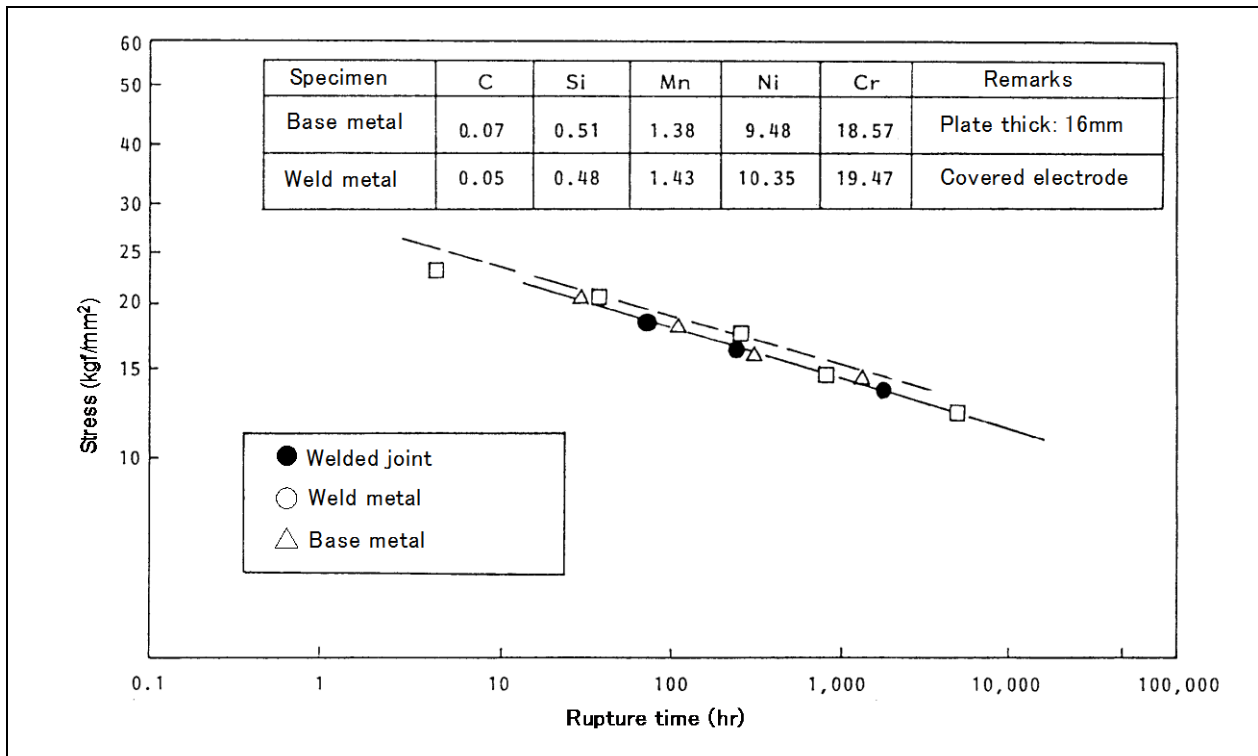

Fig. 2.17 — A comparison between 304-type steel, E308 weld metal and welded joint on creep rupture strength (as-welded specimens; test temperature: 650°C) (1 kgf/mm² = 9.8 MPa)

As mentioned in the previous section, ferrite-containing austenitic stainless steel weld metals are more resistible to hot cracking. However, it should be noted that such a ferrite-containing weld metal can precipitate non-magnetic, intermetallic compounds of iron and chromium known as “sigma phase,” when the weld metal is exposed to the temperatures in the 600 to 800°C range for a long time. The sigma phase can cause a decrease in the ductility and toughness of the weld metal, the phenomenon of which is called “sigma-phase embrittlement.” Fig. 2.18 shows the effect of thermal aging on the notch toughness of the weld metal. With higher ferrite content, the reduction of notch toughness of the weld metal is more significant. This tendency is more pronounced in 316-type weld metal than in the 308 type. This figure suggests that 316-type weld metals should be designed so that they contain a lower amount of ferrite when they are subject to elevated temperature services for long hours. To minimize the sigma-phase embrittlement, E16-8-2 filler metal (16%Cr-8%Ni-2%Mo) is sometimes used for welding 316- and 347-type stainless steels.

On the other hand, sigma phase can also precipitate in the weld metals in the as-welded condition. Even in fully austenitic 310-type stainless steel, sigma phase can directly precipitate from austenite phase when exposed to high temperatures for long hours.

The precipitation of sigma phase is affected by the alloying elements; that is, carbon and nickel inhibit the precipitation whereas the ferrite forming elements such as chromium, silicon, molybdenum and niobium accelerate the precipitation. Heat-treating (solution heat treatment) a sigma-embrittled weld metal by around 1050°C for a short time followed by rapid cooling, the sigma phase dissolves into the matrix and, in turn, the notch toughness of the weld metal recovers.

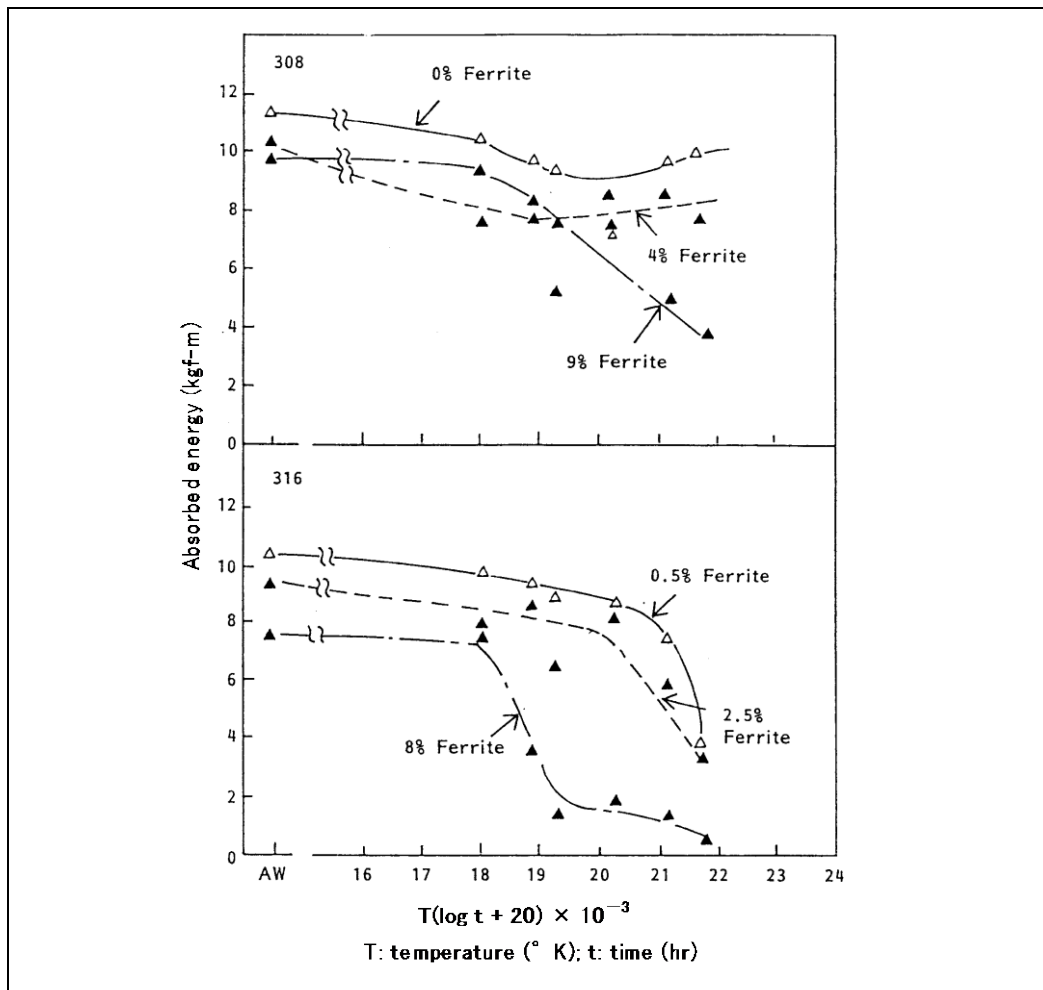

Fig. 2.18 — Effect of ferrite content on notch toughness of austenitic stainless steel weld metals heated at high temperatures for long hours (1 kgf-m = 9.8 J)

2.4.3 Mechanical properties at low-temperatures

Austenitic stainless steel does not exhibit a distinct ductile-brittle transition behavior in its notch toughness, unlike ferritic steels; therefore, it provides high notch toughness at cryogenic temperatures as shown in Fig. 2.19. This advantage makes austenitic stainless steel suitable for the storage tanks for liquefied gases of natural gas, oxygen, nitrogen and argon. The tensile properties of the welded joint at cryogenic temperatures exhibit the tendency similar to that of the base metal. That is, the strength increases, as the testing temperature becomes lower, while the elongation decreases slightly. Fig. 2.20 shows a comparison between Type 308 weld metals made by several welding processes and Type 304 base metal on notch toughness at -196°C . The weld metal has lower notch toughness compared with the base metal, and the toughness of the HAZ mediates between those of the base metal and the weld metal.

The toughness of the weld metal is influenced by ferrite content. With lower ferrite content, the toughness becomes higher as shown in Fig. 2.21. For this reason, shielded metal arc welding electrodes containing a small amount of ferrite are used in the cryogenic temperature applications such as LNG storage tanks. In contrast, TIG weld metals feature sufficient notch toughness at cryogenic temperatures due to inherently lower oxygen contents. Therefore, no restriction is needed in ferrite content for TIG weld metals.

Fig. 2.19 — A comparison between several different types of steels on notch toughness as a function of testing temperature (1 kgf-m = 9.8 J)

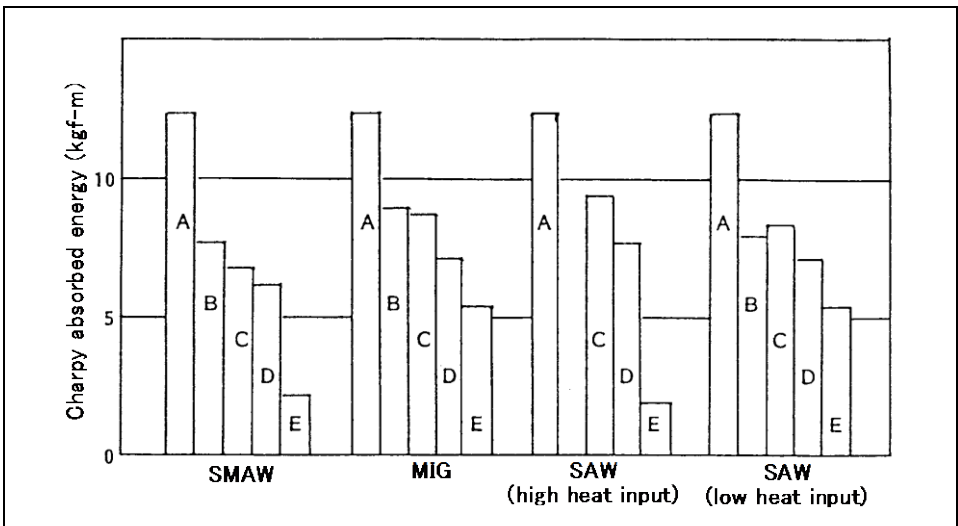
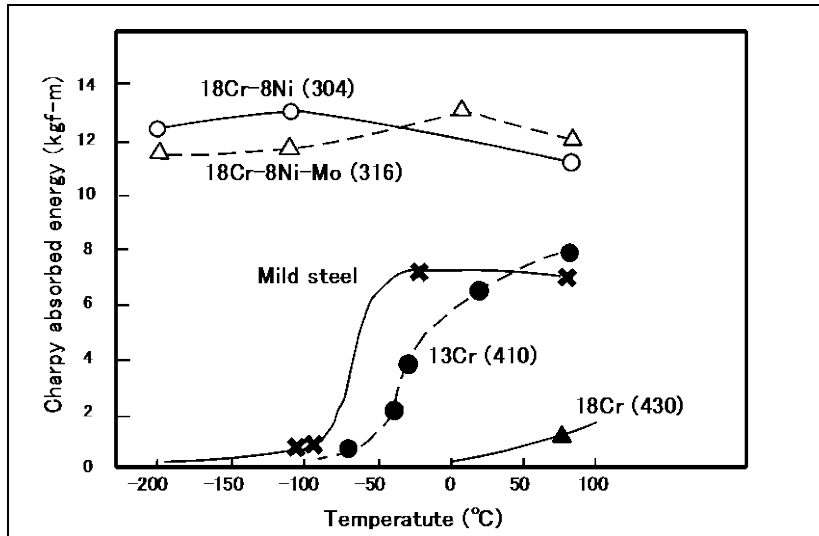
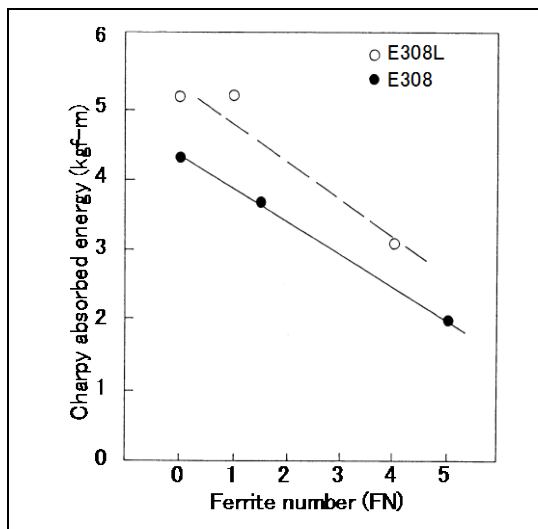

Fig. 2.20 — A tendency of notch toughness of 304-type steel welds at -196°C
A: Base metal (304 type)
B: HAZ (12.7mm from fusion line)
C: HAZ (3.2mm from fusion line)
D: HAZ (1.6mm from fusion line)
E: Weld metal (308 type)
 (1 kgf-m = 9.8 J)

Fig. 2.21 — Effect of ferrite content on notch toughness of 308- and 308L-type weld metals at -196°C (1 kgf-m = 9.8 J)



3. Metallurgical properties and weldability of iron-chromium stainless steels

3.1 Martensitic stainless steel

Typical martensitic stainless steels are Types 410 and 403 containing 13%Cr. Unlike austenitic stainless steel, martensitic stainless steels have a transformation point at around 800-850°C. Therefore, heating this steel at high temperatures in the range above this transformation point, followed by air cooling, causes the transformation of austenite to martensite having very high hardness. **Fig. 3.1** shows a typical time-temperature-transformation diagram for Type 410 stainless steel, illustrating the case of quenching to martensite.

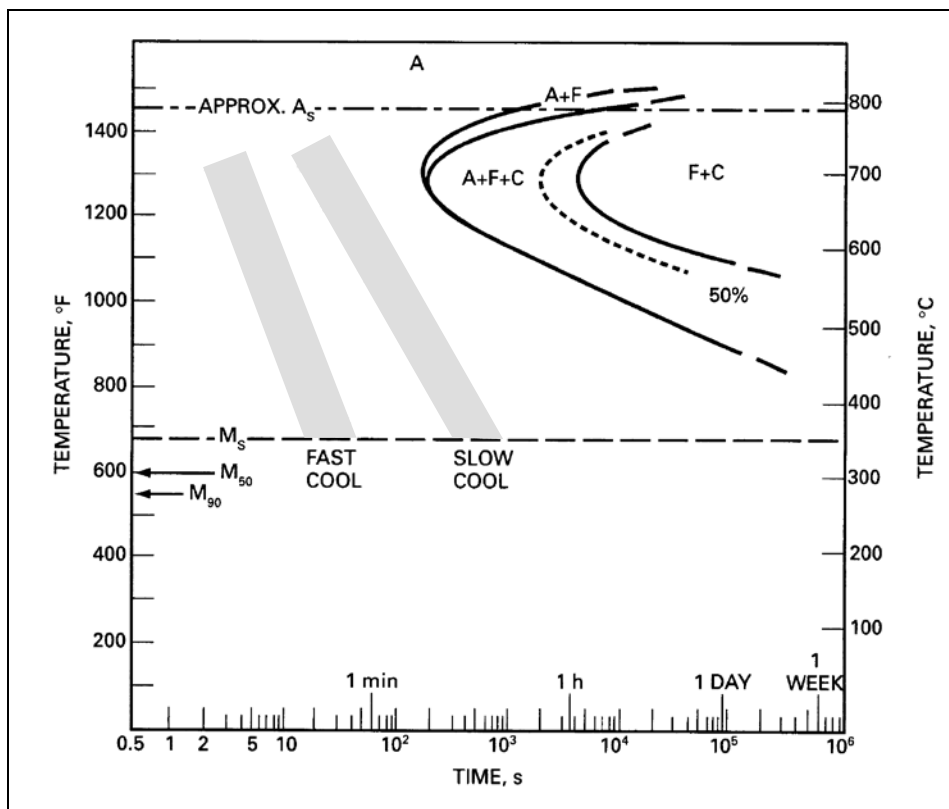
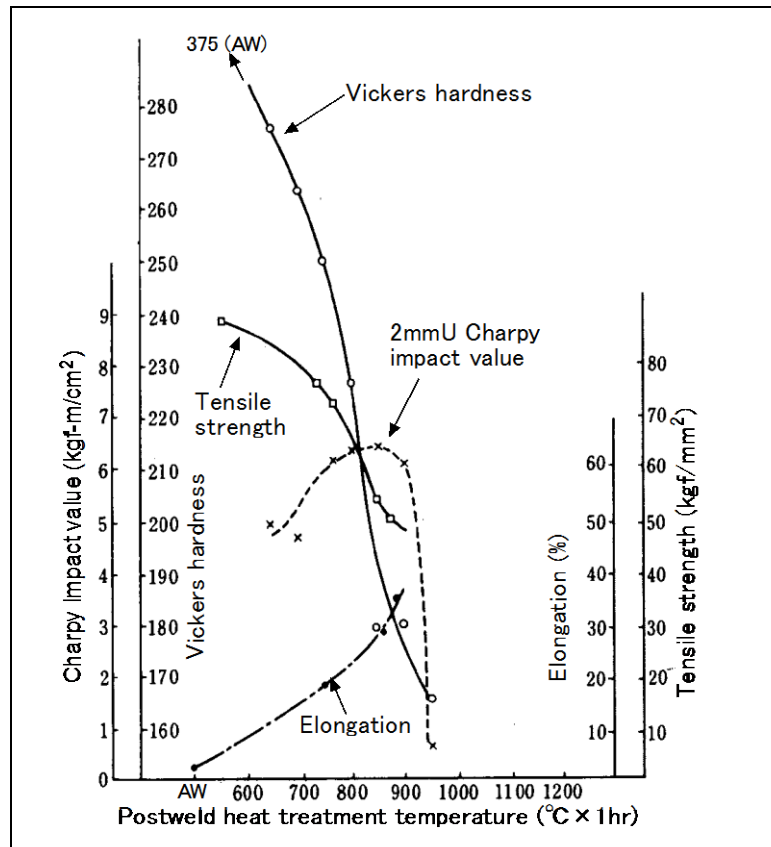

Fig. 3.1 — Time-temperature-transformation diagram for Type 410 stainless steel (Source: AWS Welding Handbook)

In welding this type of steel, the microstructures of the HAZ and compositionally matching weld metal become quenched martensite. The martensite is very brittle and hard structure having a Vickers hardness over 300. Therefore, cracking is likely to occur in welds. To prevent this cracking, the controls of preheat (200-400°C) and interpass temperatures are necessary. Postweld heat treatment (PWHT) is also necessary to temper the postweld martensitic structure, thereby improving the mechanical properties of the weld metal and HAZ.

Fig. 3.2 shows changes in the mechanical properties of AWS E410 (13%Cr) weld metal as a function of PWHT. As PWHT temperature increases over 600°C, the Vickers hardness of the weld metal sharply decreases whereas the elongation increases. The notch toughness can be improved, as PWHT temperature increases up to around 850°C, but it decreases sharply when the temperature exceeds 900°C. The HAZ of the base metal will be subject to the similar changes in mechanical properties as for the weld metal. The PWHT temperatures normally used for tempering or annealing 13%Cr steel welds are in the range of 700-760°C.

Fig. 3.2 — Changes in mechanical properties of E410 (13%Cr) weld metals as a function of postweld heat treatment temperature
 (1 kgf-m/cm² = 9.8 J/cm²)
 (1 kgf/mm² = 9.8 MPa)



In addition to Type 410 filler metal, Type 409Nb (e.g. AWS E409Nb) filler metal is also used for welding 410- and 403-type stainless steels. Unlike 410-type weld metal, 409Nb-type weld metal features a fully ferritic microstructure with fine grains as shown in **Photo 3.1**, which can be attributed to a high percent of niobium (0.50-1.50%). Niobium combines with carbon, thereby preventing the precipitation of martensite; consequently, the weld metal solidifies to be a fully ferritic structure. The fine ferritic grains are provided by the addition of small amounts of aluminum and titanium. The mechanical properties of 409Nb-type weld metal are quite good in the as-welded condition, as shown in **Fig. 3.3**, which can be further improved by PWHT. However, 409Nb-type filler metals are not suitable for the work that is to be quench-hardened after welding, because 409Nb-type weld metals have no quench-hardenableity.

Photo 3.1 — Fine ferritic structure of E409Nb weld metal (left) and martensite + ferrite structure of conventional E410 weld metal (right)

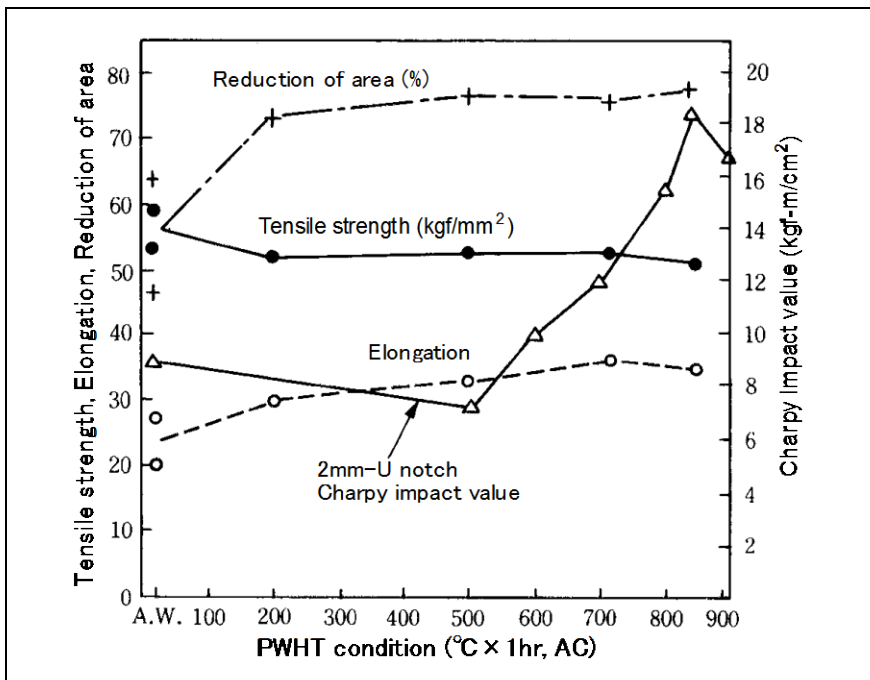
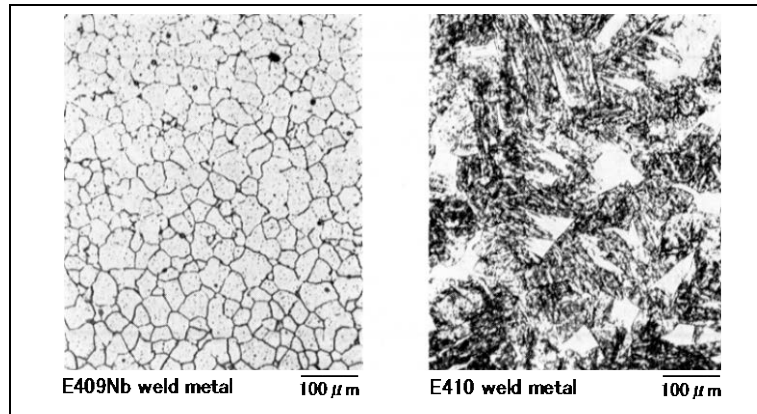

Fig. 3.3 — Mechanical properties of 409Nb-type weld metal in the as-welded and PWHT conditions.
 (1 kgf-m/cm² = 9.8 J/cm²)
 (1 kgf/mm² = 9.8 MPa)

The covered electrodes for welding martensitic stainless steels should be of low-hydrogen type to minimize cold cracking (delayed cracking) in the welds. PWHT should also be applied for better mechanical properties. In addition to compositionally matched filler metals, an austenitic stainless steel filler metal (such as E309) or nickel-alloy filler metal (such as ENiCrFe-1) can also be used. However, before making a decision of using such a compositionally unmatched filler metal for production, the welding procedure should carefully be evaluated in terms of the differences in the coefficient of thermal expansion, mechanical properties and corrosion resistance of the weld metal and the base metal, taking into account the intended service conditions.

13%Cr-Ni cast steel is a variation of martensitic stainless steel, which contains a few percent of nickel and is widely used for large steel castings such as turbine runners for power stations. The addition of nickel to 13%Cr steel can increase both strength and toughness and improve weldability. In addition, low-carbon 13%Cr martensitic stainless steel has been used for seamless pipes for gas flow lines [Ref.: *Stainless Steel World*, Nov. 1999]. This steel has better weldability compared with conventional 410-type steel, containing very low carbon of 0.005-0.013%, little lower chromium of 10.8-11.2% and an addition of nickel of 1.40-1.60%.

3.2 Ferritic stainless steel

Ferritic stainless steels are iron-chromium-carbon alloys with a sufficient amount of chromium or chromium plus such ferrite stabilizers as aluminum, niobium, molybdenum, and titanium to inhibit the formation of austenite on heating. Types 430 (17%Cr) and 405 (13%Cr-Al) stainless steels form a brittle, coarse ferrite structure, partly containing martensite, when they are heated over 900°C followed by air cooling. **Photo 3.2** shows the microstructure of the weld of Type 405 stainless steel welded with a 13%Cr-Nb (AWS E409Nb) electrode. The coarse ferrite grains exist at the area adjacent to the fusion line in the HAZ of the base metal. Unlike the HAZ, the weld metal exhibits a fine grain ferrite structure because of the Nb-bearing weld metal. Likewise, as shown in **Photo 3.3**, a 17%Cr-Nb filler metal (AWS E430Nb) that is formulated by the same technique as for the E409Nb electrode exhibits a fine ferritic structure, in contrast to a 17%Cr filler metal (AWS E430) forming a coarse ferrite structure of weld metal.

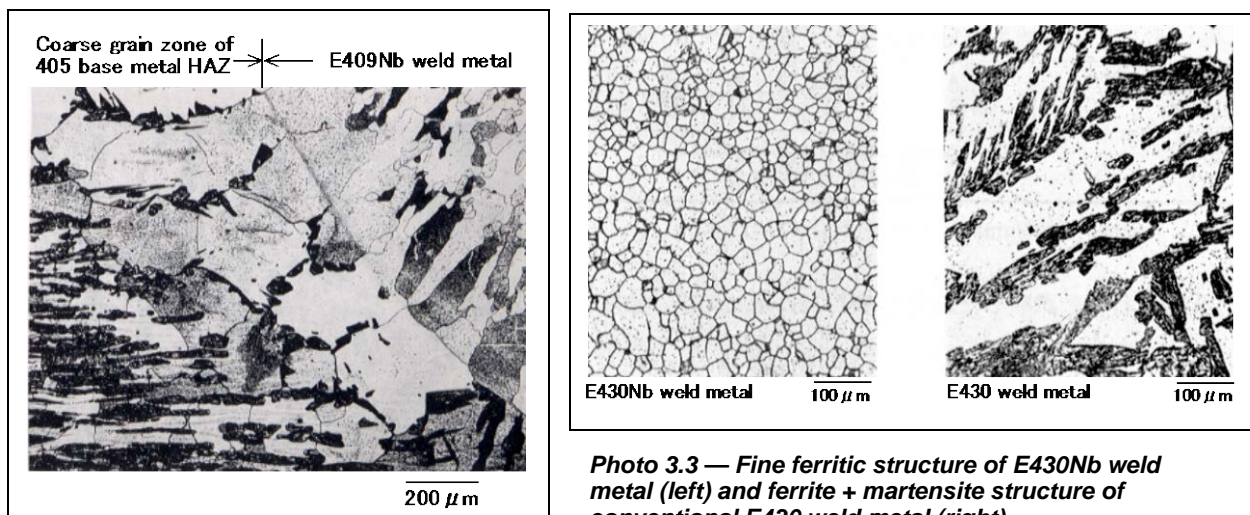

Photo 3.2 — Microstructures around the fusion line of the weld made of 405-type base metal and E409Nb weld metal

Photo 3.3 — Fine ferritic structure of E430Nb weld metal (left) and ferrite + martensite structure of conventional E430 weld metal (right)

The coarse ferrite grains, whichever in the HAZ or weld metal, cannot be refined by postweld heat treatment (PWHT). Accordingly, the notch toughness of them cannot be improved, although the ductility can somewhat be improved. **Fig. 3.4** shows the effect of postweld heat treatment on the mechanical properties of E430 weld metals. PWHT at 700-800°C can improve the ductility (elongation and reduction of area) of the weld metal, but cannot improve the notch toughness. This tendency can also be true for the HAZ of Type 430 base metal. Unlike E430 weld metals, E430Nb weld metals exhibit good mechanical properties in both the as-welded and postweld heat-treated conditions as shown in **Fig. 3.5**. In the case of Type 405 stainless steel, PWHT at around 700°C can restore the notch toughness of the HAZ of the base metal, as shown in **Fig. 3.6**.

The use of low-hydrogen type covered electrodes for welding ferritic stainless steels and the appropriate control of preheat (100-200°C) and interpass temperatures are the effective means of preventing cold cracking (delayed cracking) in the welds. PWHT should be applied to obtain better mechanical properties.

In addition to compositionally matched filler metals, an austenitic stainless steel filler metal (such as E309) or nickel-alloy filler metal (such as ENiCrFe-1) can also be used. However, before making a decision of using such a compositionally unmatched filler metal for production, the welding procedure should carefully be evaluated in terms of the differences in the coefficient of thermal expansion, mechanical properties and corrosion resistance of the weld metal and the base metal, taking into account the intended service conditions.

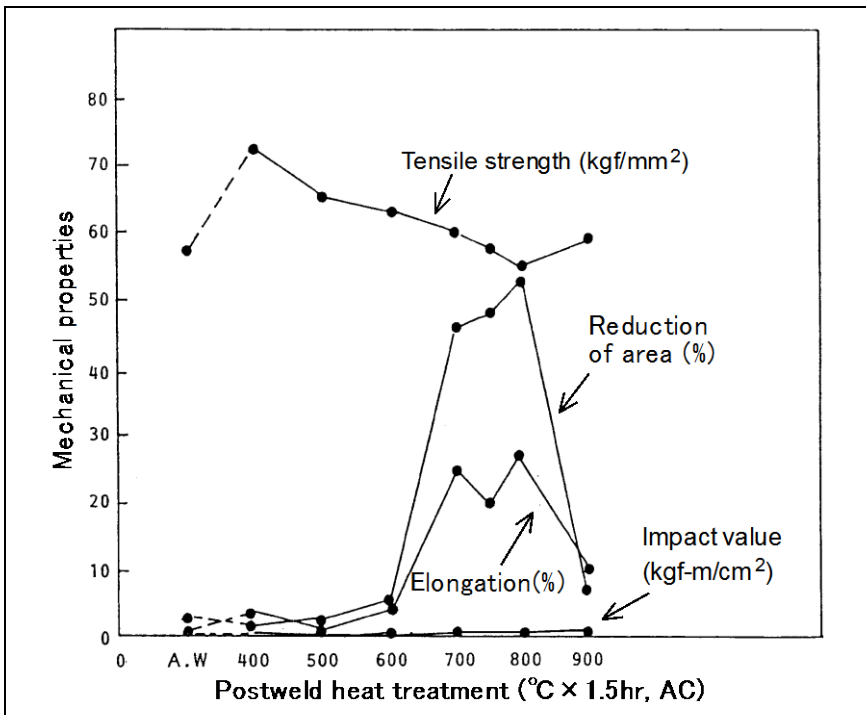

Fig. 3.4 — Effect of postweld heat treatment on mechanical properties of E430 weld metal
 (1 kgf-m/cm² = 9.8 J/cm²)
 (1 kgf/mm² = 9.8 MPa)

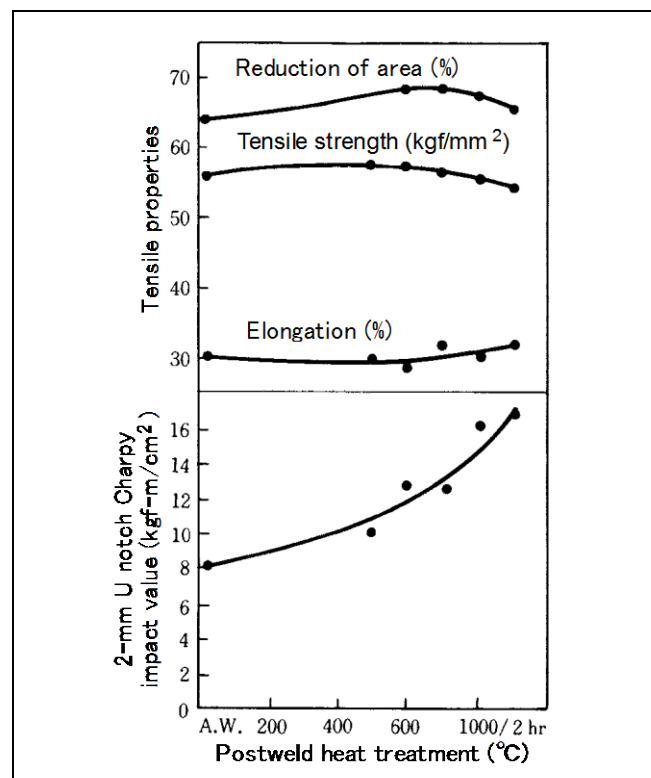
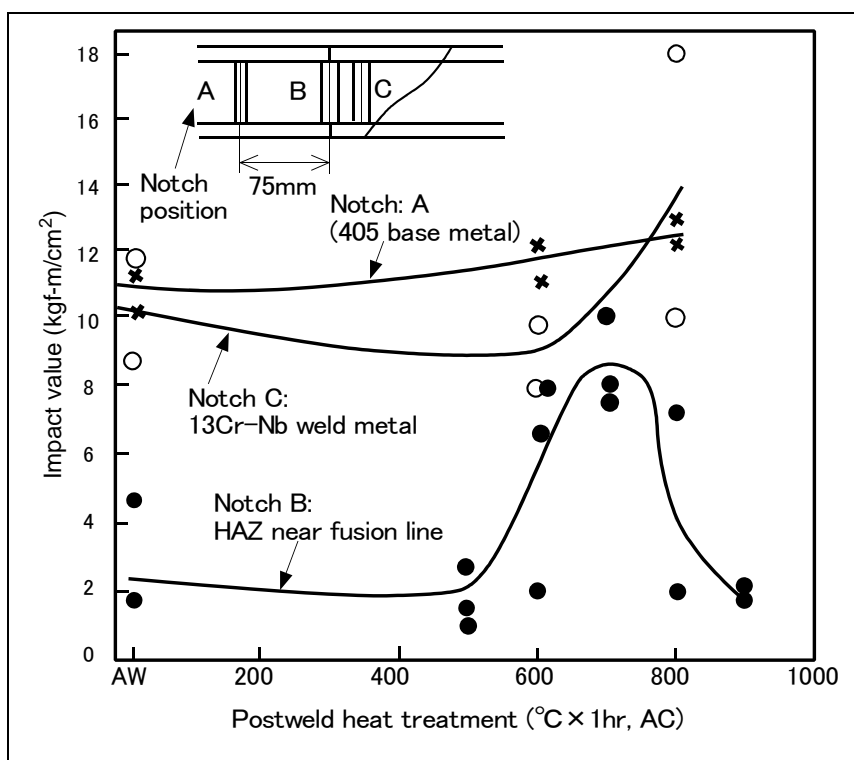

Fig. 3.5 — Effect of postweld heat treatment on mechanical properties of E430Nb weld metal
 (1 kgf-m/cm² = 9.8 J/cm²)
 (1 kgf/mm² = 9.8 MPa)

Fig. 3.6 — Effect of postweld heat treatment on impact value of 405-type base metal, weld metal and heat-affected zone
(1 kgf-m/cm² = 9.8 J/cm²)



The ferritic stainless steel heated at certain high temperatures may suffer specific types of embrittlement: “475°C-embrittlement,” “high-temperature embrittlement” caused by grain growth, and “sigma-phase embrittlement” as in the case of austenitic stainless steel. The 475°C-embrittlement is peculiar to ferritic stainless steels. Heating the chromium stainless steel with 15% or higher chromium at a high temperature in the 370 to 540°C range for long hours or cooling it slowly in this temperature range can cause a decrease in the ductility of the steel. This embrittlement is referred to as 475°C-embrittlement because it occurs to the highest degree at a temperature of around 475°C. The 475°C-embrittlement occurs more markedly as the chromium content is higher, and the heating time is longer. Therefore, in the welding of high-chromium stainless steels, excessively high preheat and interpass temperatures should be avoided, and the heat input should be minimized.

3.3 Delayed cracking

Delayed cracking in iron-chromium stainless steels occurs caused mainly by diffusible hydrogen in welds, in the same way as cold cracking in high-strength steels and heat-resistant low-alloy steels. In iron-chromium stainless steel welds, the diffusion rate of dissolved diffusible hydrogen is as low as one-tenth to one-25th the diffusion rate of that in carbon steels. Therefore, the incubation period to the crack initiation is longer as such. That is, delayed cracking may occur after longer times than in carbon steels. **Fig. 3.7** shows how long times the delayed cracking can continue to occur in a 13%Cr-Nb weld metal, if preheating is not applied.

Delayed cracking is also caused by hard martensite and brittle, coarse ferrite grains in welds. To prevent the cracking, the preheat and postweld heat treatment are essential.

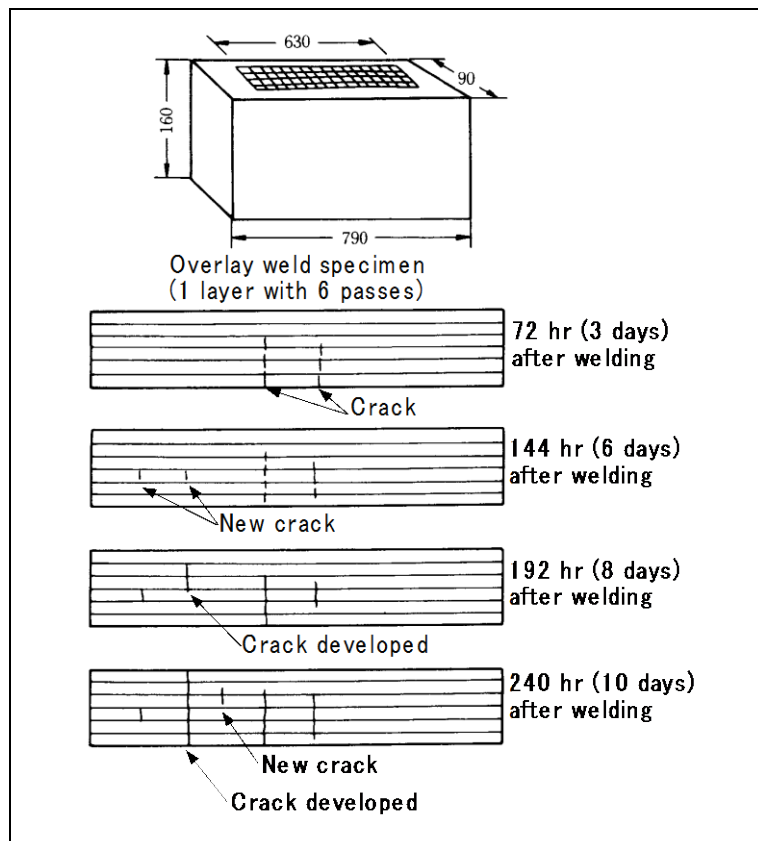

Fig. 3.7 — Results of the thick-section substrate overlay weld cracking test of an E409Nb weld metal with no preheating

3.3.1 Effects of preheating and immediate postheating

Delayed cracking can be prevented by adopting appropriate preheating and postheating. **Fig. 3.8** shows the effects of preheating and immediate postheating on the prevention of delayed cracking, which were obtained by means of the one-pass-weld slit-cracking test using an E430Nb electrode. This figure suggests that the preheating and postheating are quite effective to prevent delayed cracking.

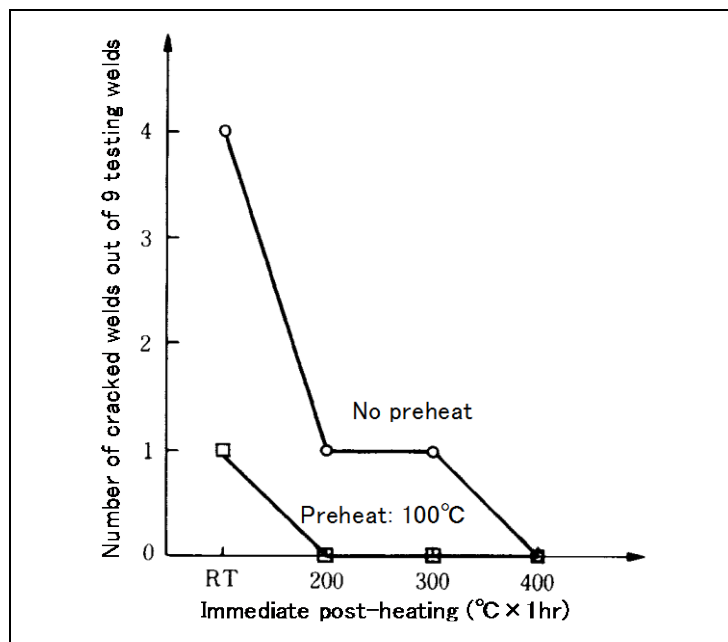

Fig. 3.8 — Effects of preheating and immediate postheating on the prevention of delayed cracking in an E430Nb weld metal by means of the one-pass-weld slit-cracking test

Normally, martensitic stainless steels are recommended to preheat by 200-400°C and ferritic stainless steels are recommended to preheat by 100-200°C. As the thickness and stiffness of the work increase, the preheating temperature should be higher within the temperature ranges.

With iron-chromium stainless steels, where the preheating by 200°C or higher temperatures is insufficient to perfectly prevent delayed cracking, it is effective to use immediate postheating by 250-400°C right after the completion of welding while the weld maintains the preheating temperature, before cooling down the weldment to the ambient temperature. Alternatively, the weld should be kept at temperatures at 100°C or higher until postweld heat treatment is ready for the work.

3.3.2 Influence of diffusible hydrogen

The main cause to delayed cracking is diffusible hydrogen in welds. **Fig. 3.9** shows how the diffusible hydrogen affects the occurrence of delayed cracks in 13%Cr-Nb and 17%Cr-Nb stainless steel overlay weld metals in the shielded metal arc welding of thick section substrates. It clearly shows that higher amounts of diffusible hydrogen cause much more cracks. This test result suggests to use low-hydrogen electrodes for welding 13%Cr and 17%Cr stainless steels and to prevent the covering flux of the electrodes from absorbing moisture in order to reduce the amount of diffusible hydrogen, thereby preventing delayed cracks in the welds. In addition, the covered electrodes should be redried before use. The proper redrying temperature and time for the covered electrodes for chromium stainless steels are 300-350°C and 30-60 minutes, respectively.

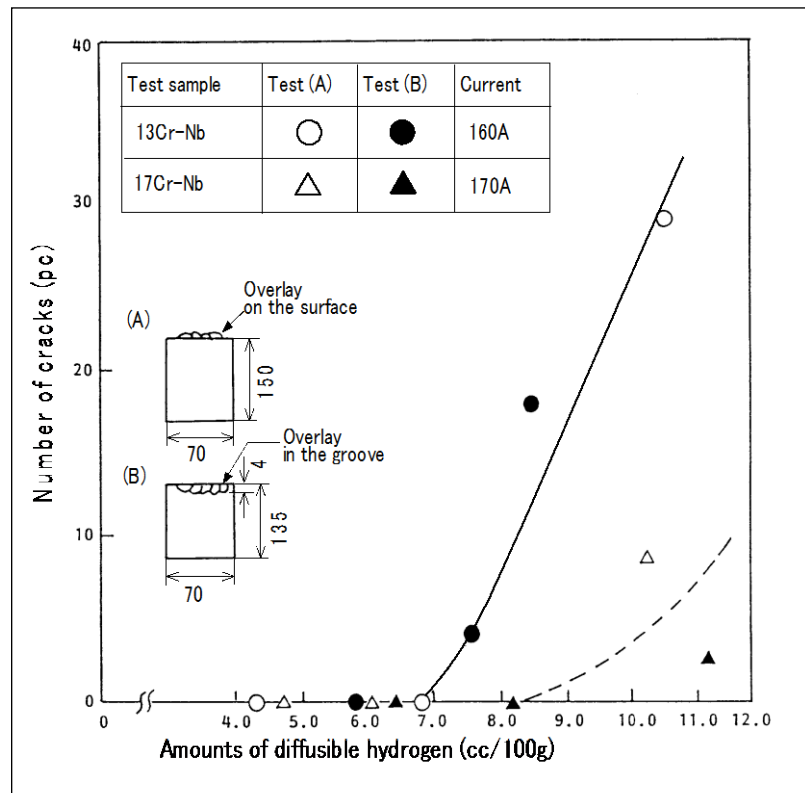

Fig. 3.9 — Effect of diffusible hydrogen on delayed cracking in 13%Cr-Nb and 17%Cr-Nb weld metals

4. Clad and dissimilar metals

As discussed in the previous section, stainless steel has excellent anti-corrosion and anti-oxidation properties with high strength at high-temperatures. It is, therefore, used for the main components of the high-temperature high-pressure equipment and chemical process machinery. However, it is not economical to use expensive stainless steels extensively for general applications for which the outstanding characteristics of stainless steels are not required. Due to such an economical reason and the design requirements for the particular service temperature and pressure, dissimilar-metal joints are often used. Dissimilar-metal joints can be observed in the welding of stainless steel-to-carbon steel, stainless steel-to-low alloy steel, and stainless steel clad steels, and in the overlaying of stainless steel weld metal onto carbon steel or low alloy steel. In the welding of these dissimilar metals, special attention should be paid to the specific matters such as chemistry changes by dilution in the weld metal, microstructural changes in the transition zone, carbon migration around the fusion boundary, and thermal fatigue in services.

4.1 Welding considerations

4.1.1 Effect of dilution on chemical composition of weld metals

In the welding of stainless steel to carbon steel, it is needed to use an appropriate welding consumable that contains higher nickel and chromium than does the stainless steel base metal. It is also necessary to properly control the penetration in the base metal in order to control the ferrite content of the weld metal. The chemical composition of the weld metal diluted by the compositionally different base metals can be estimated by using a Schaeffler diagram, as shown in Fig. 4.1. For the welding of a dissimilar metal joint shown in Fig. 4.2, which consists of austenitic stainless steel (Type 304) and carbon steel (JIS SS400), an appropriate filler metal is of E309. In this case, the chemical composition of the weld metal varies according to the penetration in the base metal, as detailed below.

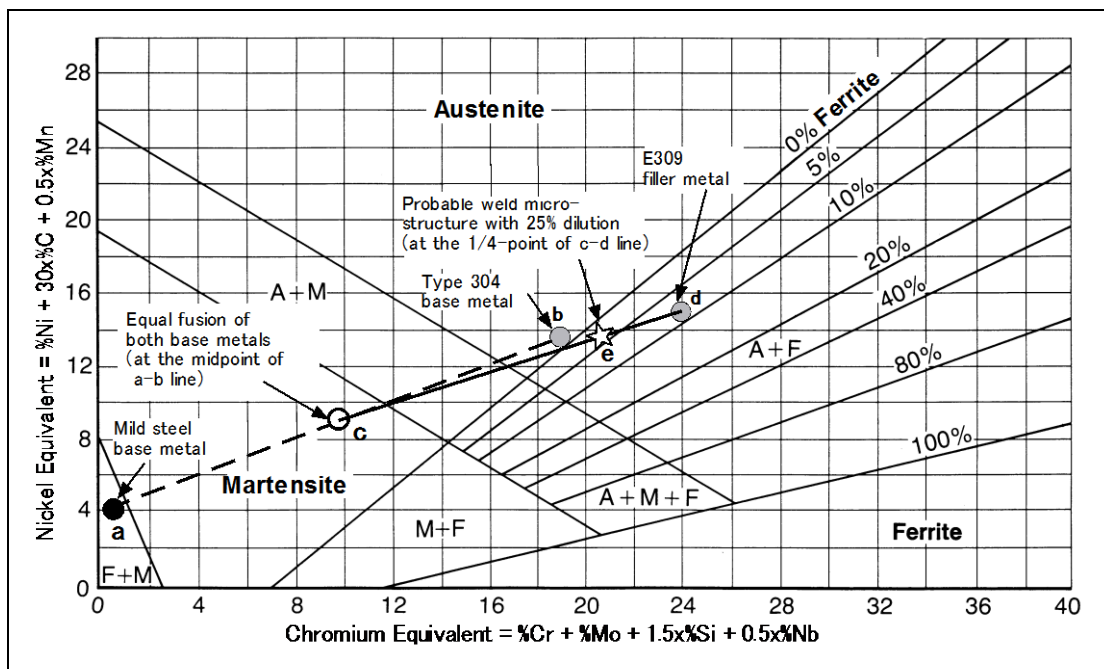
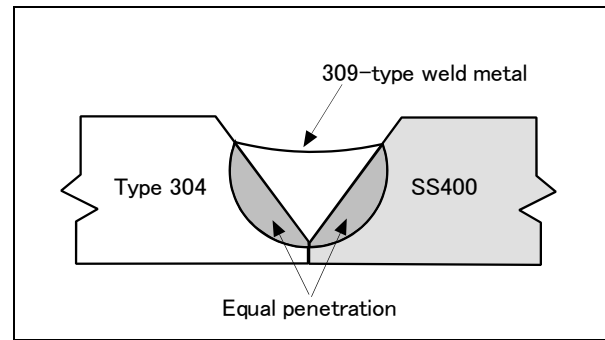

Fig. 4.1 — A Schaeffler diagram and the procedure (a⇒b⇒c⇒d⇒e) of estimating the microstructure of the 309-type diluted weld metal in welding Type 304 to mild steel.

Fig. 4.2 — A model of dissimilar metal weld joint with equal penetration



If Type 304 and SS400 will penetrate at the same ratio in welding, this dissimilar metal welding can be equivalent to the welding of the base metals having the chemical composition indicated by the point (c) that is at the midpoint between the two points (a) and (b) representing the two base metals plotted in the diagram shown in Fig. 4.1. Accordingly, the chemical composition of the weld metal created by an E309 filler metal can be found on the line connecting the point (c) and the point (d) of the E309 undiluted weld metal, though its position varies with the penetration ratio.

In a case where the weld metal needs to contain ferrite for preventing a hot crack, the penetration ratio must be controlled at below 33% (at the crossing point of the c-d line and the 0% ferrite line), in order for the chemical composition to meet the point (e) for instance. In actual welding, however, the penetration is likely to become greater on mild steel than on stainless steel, due to magnetic arc blow. The point (c), therefore, moves toward the point (a). Accordingly, the penetration ratio must be limited to a lower value than the above. On the contrary, if the penetration ratio is too low, the chemical composition of the weld metal approaches the E309 undiluted weld metal that may be subject to sigma-phase embrittlement by postweld heat treatment. Therefore, the penetration should be controlled appropriate.

4.1.2 Bond martensite and carbon migration at the boundary zone

The deposition of stainless steel weld metal or high-nickel alloy weld metal onto carbon steel or low-alloy steel creates the chemistry transition zone in the vicinity of the fusion line in the weld, where the content of the alloying elements including chromium and nickel varies continuously. **Fig. 4.3** shows the chemistry variations, analyzed by using a micro-analyzer, in the vicinity of the fusion line between carbon steel base metal and E309 weld metal. As shown in this figure, chromium (Cr), nickel (Ni), manganese (Mn) and iron (Fe) vary continuously, thus creating a concentration gradient within the range of approximately $150\ \mu\text{m}$ from the fusion line toward the weld metal.

By correlating the chemical composition of this narrow zone and a Schaeffler diagram, the microstructure can be estimated to be martensite. In addition, a microscopic test confirmed the existence of a belt-shaped martensite layer in this zone. This martensite layer is also known as “bond martensite.” The ductility of the bond martensite is so low in the as-welded condition that cold cracking may occur in this zone. To prevent such a cold crack, it is effective to use preheating and immediate postheating. Alternatively, the use of a NiCrFe-type filler metal (e.g., ENiCrFe-1) can minimize the precipitation of bond martensite.

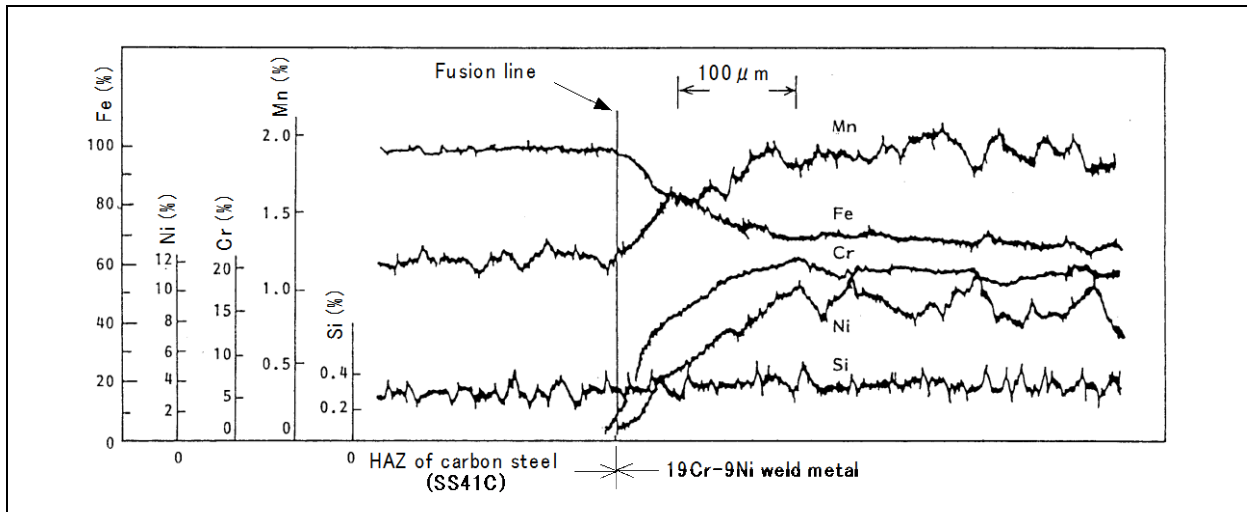

Fig. 4.3 — Chemistry variations in the vicinity of the fusion line between mild steel base metal and E309 weld metal

In the use of high nickel filler metals such as ENiCrFe-1, almost no bond martensite precipitates because the nickel content is kept sufficient in the transition zone, although the transitional variations in the content of nickel and chromium are observed near the fusion line.

Fig. 4.4 shows the notch toughness of the boundary zone of weld that consists of 980-MPa high-tensile strength steel base metal (HT100) and the weld metals of various austenitic types and compositionally matching high-strength type. Every test result shows a reduction in the notch toughness when the notch is located in the fusion line. This reduction, however, is less when the nickel content of the filler metal is higher. With a 25Cr-60Ni filler metal, the reduction in the impact value is as little as 2kgf-m/cm² (19.6 J/cm²). This is because high-nickel weld metals can accommodate much more chemistry variations in the boundary zone, featuring less hardening and embrittlement. That is why high-nickel filler metals (such as ENiCrFe-1 and ENiCrFe-3) are often used for welding dissimilar metals, when sufficient postweld heat treatment cannot be applied.

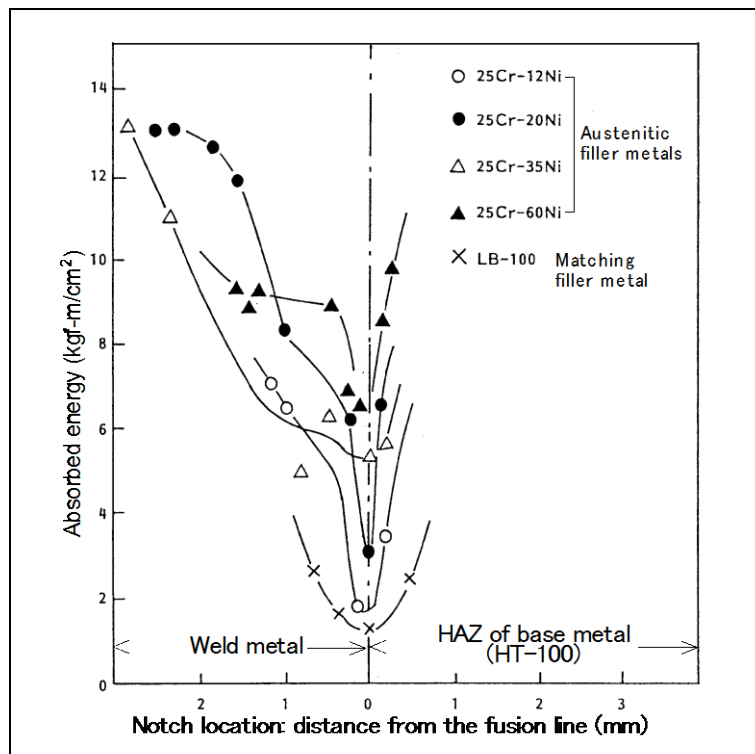

Fig. 4.4 — Notch toughness variations in the boundary zone of weld metal consisting of single-bevel groove base metal of 980-MPa high-tensile strength steel (HT100) and various types of weld metals, tested at minus 50°C (1 kgf-m/cm² = 9.8 J/cm²)

Another problem in the welding of stainless steel to carbon steel or low-alloy steel is carbon migration. Welding the dissimilar metals that contain different amounts of chromium can cause carbon migration when the weld is subject to elevated temperatures in postweld heat treatment or in services. In the carbon migration, the carbon in the lower-chromium metal migrates to the higher-chromium metal through the fusion line because of stronger Cr-to-C affinity. Consequently, a decarburized zone is formed in the lower-chromium metal, while a carburized zone is formed in the higher-chromium metal. **Photo 4.1** is a case where the carbon migration took place from 2.25Cr-1Mo steel to 19Cr-9Ni weld metal, in which the decarburized zone is formed in the Cr-Mo steel and the carburized zone is formed in the Cr-Ni weld metal. **Fig. 4.5** shows hardness distributions around the fusion line between carbon steel and E309 weld metal before and after postweld heat treatment. After the heat treatment, a sharp decrease in hardness is observed in the decarburized zone of the carbon steel while a sharp hardness increase is seen in the carburized zone of the E309 weld metal because of the carbon migration.

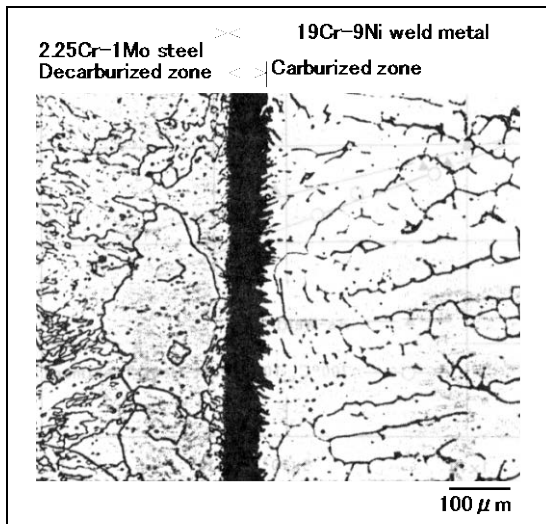
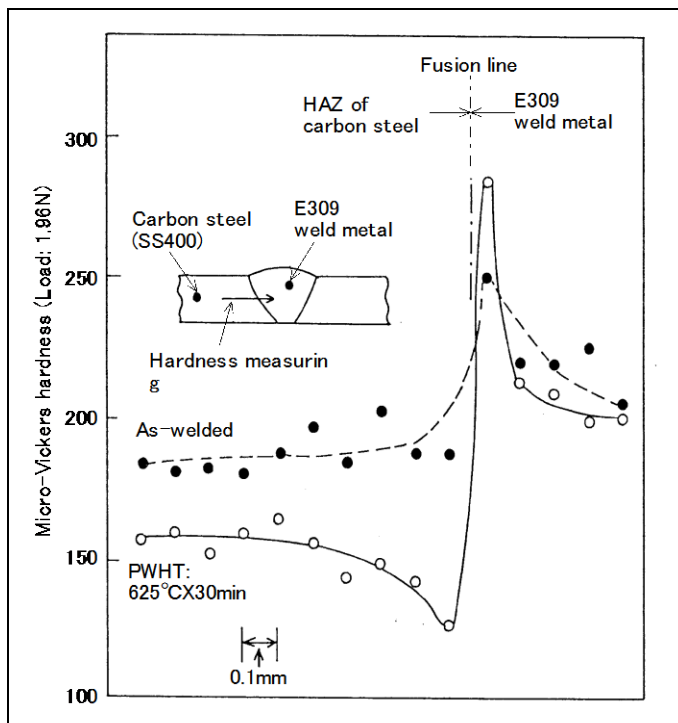

Photo 4.1 — Carburized and decarburized zones formed in a dissimilar metal joint, caused by postweld heat treatment (Above)
Fig. 4.5 — Hardness distributions around the fusion line of a dissimilar metal joint (Right)



The carburized zone precipitates carbides (mainly Cr carbide), the Vickers hardness of which can be as high as 400 or higher. Adverse effects of the carbon migration have not necessarily been revealed, but micro-fissures may occur in the carburized zone when a bending stress is applied due to a large hardness difference in the weld. Therefore, formation of the carburized zone should be minimized. Although the decarburized zone has a little influence on short-time tensile strength, it is reported that appreciable reduction has been recognized in the creep rupture strength of the weld joint with decarburization.

Generally, the extent of carbon migration is affected more significantly by temperature than by the soaking time in postweld heat treatment. Therefore, heat treatment temperature should be minimized when carbon migration is predicted for a dissimilar metal joint. Alternatively, the use of a NiCrFe-type filler metal can decrease the carbon migration. **Fig. 4.6**

shows a comparison between E310 and NiCrFe-type filler metals on the effect of postweld heat treatment in terms of carbon migration. In this figure, it is obvious that the NiCrFe-type filler metal exhibits a far less hardness variation around the fusion line of the dissimilar metal joint when compared with the E310 filler metal. This is because the carbon diffusion is hard to occur with a NiCrFe-type filler metal.

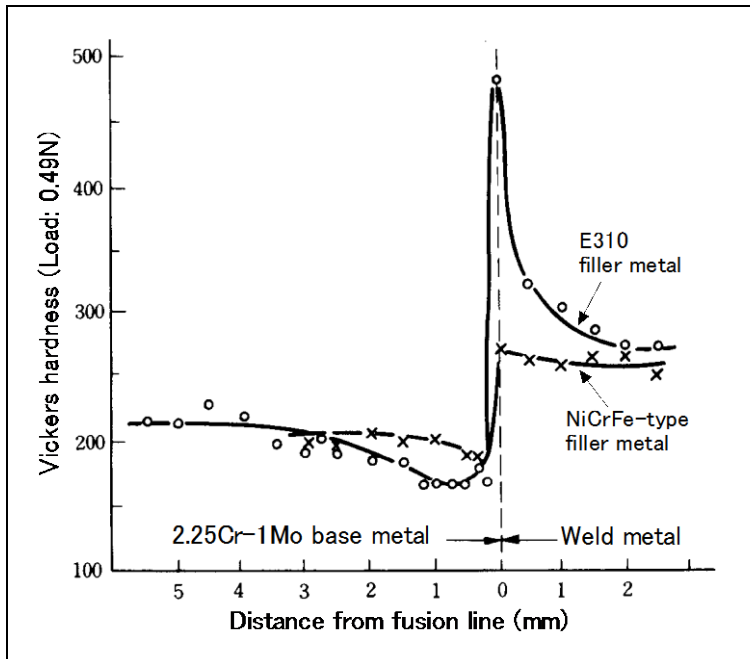

Fig. 4.6 — A comparison between E310 and NiCrFe-type weld metals on hardness distribution around the fusion line of a dissimilar metal joint after postweld heat treatment (750°C × 48hr).

4.1.3 Under-clad cracking

Under-clad cracking (UCC) is the micro cracking that may occur in the heat-affected zone (HAZ) of low-alloy steel forgings in the overlay welding by high heat input with a large-width strip electrode. As shown in **Fig. 4.7**, UCC appears perpendicularly to the welding direction in the HAZ. The cracking occurs in the coarse grain zone that has been heated in the 1150-1400°C range (over the A_3 transformation point) by the preceding overlay bead, reheated subsequently in the 500-750°C range (below the A_1 transformation point) by the succeeding lapping bead, and subjected to postweld heat treatment by around 600°C. UCC does not occur in the as-welded condition.

The occurrence of UCC is affected by the type of base metal (the UCC susceptibility parameter, $\Delta G = Cr + 3.3Mo + 8.1V - 2$, is an affecting factor), welding heat input, postweld heat treatment, and the type of overlay weld metal. The following measures can prevent UCCs.

- (1) Use the steels, such as A533B, having a low value of ΔG to minimize precipitation of M_2C carbides.
- (2) Use the steels containing low impurities to strengthen the grain boundaries.
- (3) Refine the coarse grains by using appropriate means such as double-layer cladding or induction heating.
- (4) Minimize heat input.

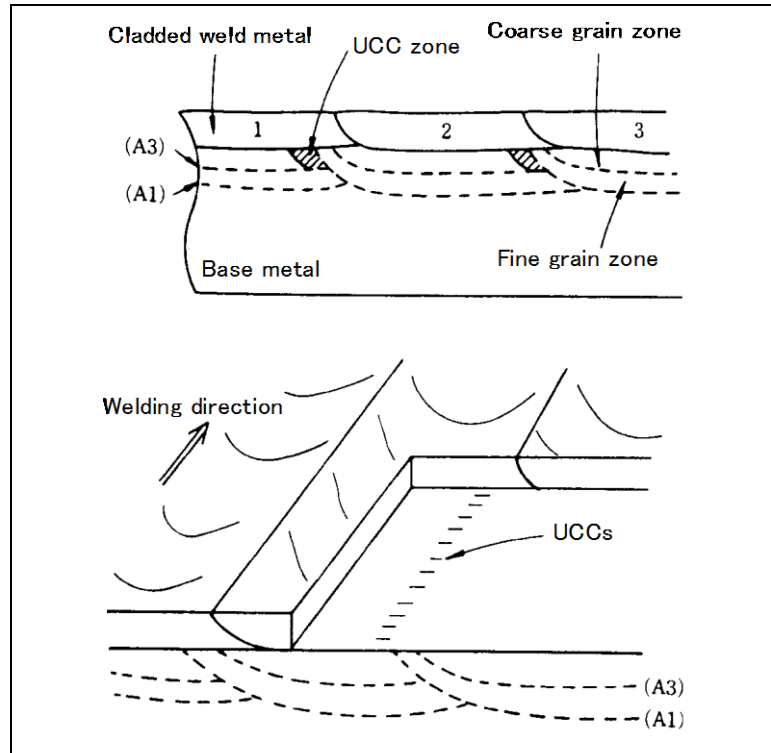

Fig. 4.7 — Locations of under-clad cracking in austenitic stainless steel overlay welds laid on a low-alloy steel substrate by using a large-width strip electrode

4.2 Service considerations

4.2.1 Thermal fatigue

Austenitic stainless steel has a coefficient of thermal expansion of approximately 1.5 times as great as that of carbon steel and low-alloy steel. When a dissimilar-metal weld joint is subject to a sudden temperature change (thermal shock) and the temperature change is repeated (thermal fatigue), the thermal stresses caused by the difference in coefficient of thermal expansion may be induced in the weld, which in turn may cause cracks in the boundary zone. The cracking may cause premature failure of the weldment. **Fig. 4.8** shows results of the thermal fatigue test conducted on a dissimilar-metal weld joint that consists of 2.25Cr-1Mo steel and 304L-type steel welded with an E309 welding electrode. Both ends of the welded joint were fixed during the test. The welded joint was then repeatedly subjected to the temperature changes between room temperature and various elevated temperatures to generate thermal stresses. The figure shows the relationship between the maximum heating temperature and the number of cycles to failure. As the maximum heating temperature becomes higher (i.e., with greater thermal stresses), the thermal fatigue failure occurs more quickly with smaller numbers of thermal cycles. The test results also show that the postweld-heat-treated specimens (with decarburized layers) exhibit a lower thermal fatigue life as compared with the as-welded specimens.

In the welding of a dissimilar-metal joint consisting of austenitic stainless steel and ferritic steel, the problem caused by the difference in thermal expansion coefficient cannot perfectly be avoided. But, it is possible to reduce the adverse effects, by using the welding consumable having an intermediate thermal expansion coefficient between those of austenitic and ferritic steels. From this point of view, it is advisable to use NiCrFe-type welding consumables (whose thermal expansion coefficient is approximately 1.1 times that of carbon steel) for welding the dissimilar-metal joint that will be subject to greater temperature changes during operation.

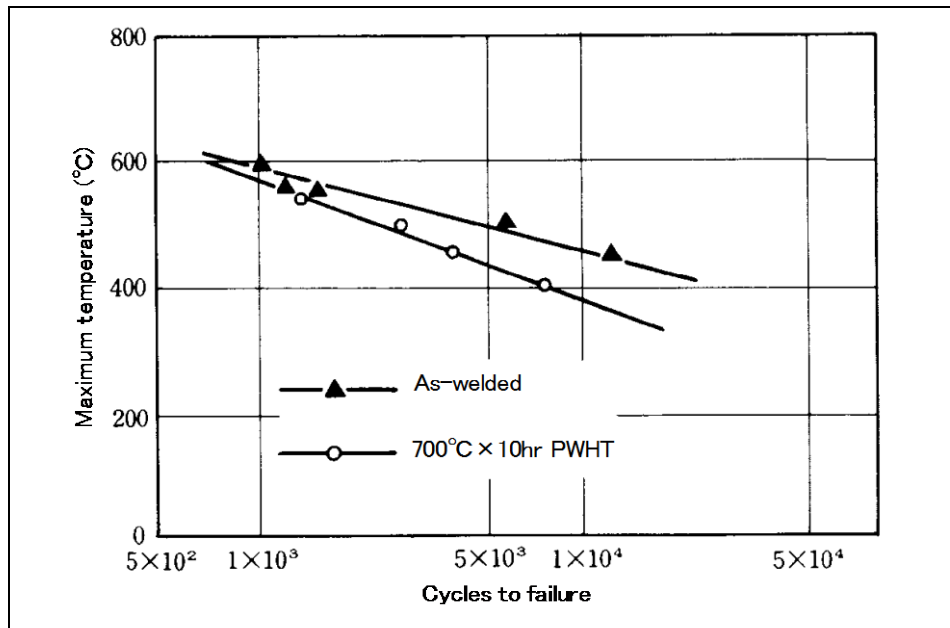

Fig. 4.8 — Results of thermal fatigue test of the dissimilar-metal weld joint consisting of 2.25Cr-1Mo base metal, E309 weld metal, and Type 304L base metal

4.2.2 Hydrogen-induced disbonding of cladded weld metals

Hydrogen-induced disbonding may occur in the weld metal adjacent to the fusion line of the cladded weld when pressure vessels, such as oil refinery reactors operated in high-temperature high-pressure hydrogen atmospheres, are shut down. During the operation, the pressurized hydrogen diffuses into the cladded stainless steel weld metal and accumulates in the vicinity of the fusion line. The accumulated hydrogen causes the disbonding, which is believed to be a kind of delayed cracking caused by hydrogen. The disbonding includes two different types of cracking as shown in **Photo 4.2**. One type (Type I) is the cracking occurred along the carbide precipitation zone (carburized zone) of the weld metal. The other type (Type II) is the cracking occurred along the coarse grain zone of the weld metal in the transition zone of the cladded weld.

The occurrence of disbonding is affected by operational conditions (hydrogen pressure and temperature) of pressure vessels and the cooling rates on shutting down. Also the chemical compositions of the base metal and weld metal as well as grain growth are the affecting factors. **Fig. 4.9** shows the relationship between the amount of coarse grains in the weld metal adjacent to the fusion line and the sensitivity to the Type-II disbonding with several overlay-welding processes. The shielded metal arc welding (SMAW) and submerged arc welding (SAW) processes generate smaller amounts of coarse grains and exhibit lower sensitivity to the disbonding. By contrast, as the heat input increases, as in the case of electroslag welding (ESW) with 75- or 150-mm width strip electrodes, higher amounts of coarse grains are generated; thus, the crack sensitivity increases. From these facts, the first layer by SAW followed by ESW for the second layer is a recommended overlay procedure to prevent the disbonding.

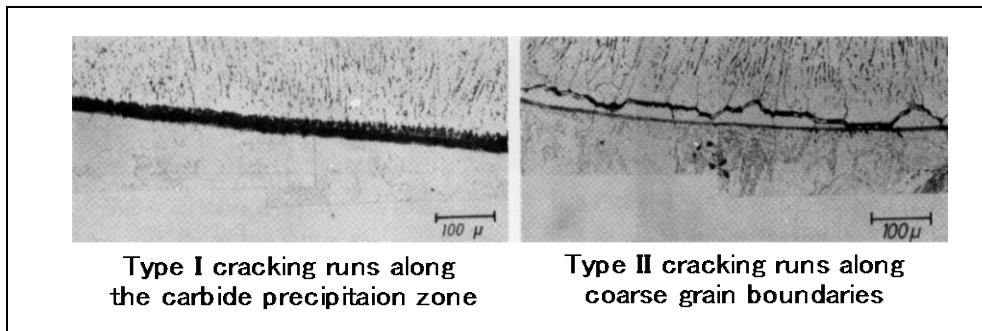

Photo 4.2 — Typical cracks occurred in the vicinity of the transition zone of the austenitic stainless steel weld cladded on a low-alloy base metal

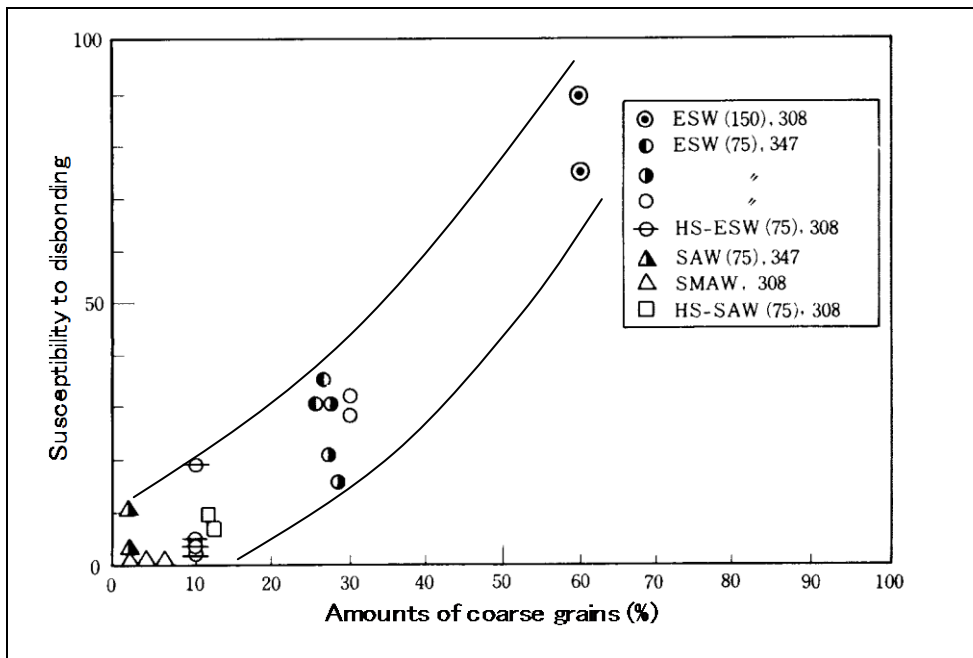

Fig. 4.9 — Susceptibility to the disbonding of cladded austenitic stainless steel weld metals as a function of the amount of coarse grains
 •The figures entered in the parentheses indicate the width of strip electrodes
 •308 and 347 indicate the types of cladded weld metals
 •ESW: electroslag welding; HS-ESW: high-speed ESW; SAW: submerged arc welding; SMAW: shielded metal arc welding; HS-SAW: high-speed SAW

4.3 Welding procedures and welding consumables

4.3.1 Welding of dissimilar-metal joints

In the welding of dissimilar-metal joints, different types of base metals are welded. Welding consumables for dissimilar-metal joints should be selected by considering the following factors: the compositional and mechanical properties of each of the base metals, possible changes in the properties of the weld metal affected by dilution with the base metals, the influences of postweld heat treatment, and the environment where the welded structure is to be installed and operated. **Table 4.1** shows a quick guide to welding consumables, which may be suitable for joining several combinations of dissimilar metals by groove welding and fillet welding.

Table 4.1 — A quick guide to proper welding consumables for groove and fillet welding of dissimilar metals

Base metal combination		Proper welding consumable ⁽¹⁾			
Base metal A	Base metal B	SMAW ⁽²⁾	GMAW ⁽³⁾	GTAW ⁽³⁾	FCAW ⁽⁴⁾
Carbon steel, Low-alloy steel	Austenitic stainless steel (Type: 304, 304L)	E309 E309L ENiCrFe-1 ENiCrFe-3	ER309 ER309LSi ERNiCr-3	ER309 ER309L ERNiCr-3	E309T E309LT ENiCr3T
	Austenitic stainless steel (Type: 316L, 317L)	E309 E309L E309LMo ENiCrFe-1 ENiCrFe-3	ER309 ER309LSi ERNiCr-3	ER309 ER309L ERNiCr-3	E309T E309LT E309LMoT ENiCr3T
	Austenitic stainless steel (Type: 321, 347)	E309 E309L ENiCrFe-1 ENiCrFe-3	ER309 ER309LSi ERNiCr-3	ER309 ER309L ERNiCr-3	E309T E309LT ENiCr3T
	Martensitic stainless steel (Type: 403, 410)	E309 E309L E430Nb ENiCrFe-1 ENiCrFe-3	ER309 ER309LSi ERNiCr-3	ER309 ER309L ERNiCr-3	E309T E309LT ENiCr3T
	Ferritic stainless steel (Type: 405, 430)	E309 E309L E430Nb ENiCrFe-1 ENiCrFe-3	ER309 ER309LSi ERNiCr-3	ER309 ER309L ERNiCr-3	E309T E309LT ENiCr3T

Note: (1) ENiCrFe-1, ENiCrFe-3, ERNiCr-3, and ENiCr3T are suitable for an application that is subject to thermal cycle or high temperatures over approximately 400°C.

(2) AWS A5.4:2012 (Stainless Steel Electrodes for Shielded Metal Arc Welding)

A5.11:2010 (Nickel and Nickel-Alloy Welding Electrodes for Shielded Metal Arc Welding)

(3) AWS A5.9:2012 (Bare Stainless Steel Welding Electrodes and Rods)

A5.14:2011 (Nickel and Nickel-Alloy Bare Welding Electrodes and Rods)

(4) AWS A5.22:2012 (Stainless Steel Flux Cored and Metal Cored Welding Electrodes and Rods)

A5.34:2013 (Nickel-Alloy Electrodes for Flux Cored Arc Welding)

In the welding of carbon steel or low-alloy steel to austenitic stainless steel (such as Types 304 and 316), 309- and 309LMo-type welding consumables containing greater amounts of nickel and chromium than those of the respective base metal are commonly used. This is because the use of compositionally matched 308- and 316-type welding consumables may result in decreases in the nickel and chromium content of the weld metal due to dilution with the ferritic base metal, which may cause hot cracking and cold cracking. A 310-type welding consumable may be recommended in some welding guidebooks, but preventive measures against hot cracking should be employed because it will result in a fully austenitic weld metal.

Even with a 309-type welding consumable, the joining of the stainless steel casting and JIS S45C (equivalent to AISI 1045) carbon steel containing high carbon may result in hot cracking in the weld metal. In such a case, it is better to use a 312-type welding consumable, which contains higher ferrite and, thus, can provide weld metals with less hot cracking sensitivity.

In the multiple-pass welding of thick plates, the use of a 309-type welding consumable for each pass results in a high-ferrite weld metal because of less dilution by the base metal. The high-ferrite weld metal has no problem as far as it is used at normal temperatures in the as-welded condition. However, ferrite can cause sigma-phase embrittlement when the weld metal is subject to postweld heat treatment or, even if in the as-welded condition, high temperature operations. In such a case, it is recommended to clad 309-type weld metals onto the surfaces of the carbon steel in advance (the buttering technique); subsequently, conduct the groove welding by using a compositionally matched 308-type welding consumable, as shown in **Fig. 4.10**.

Table 4.1 recommends NiCrFe-type welding consumables for some combinations of dissimilar metals. This is to prevent the embrittlement caused by carbon migration and the thermal fatigue as discussed in the previous section.

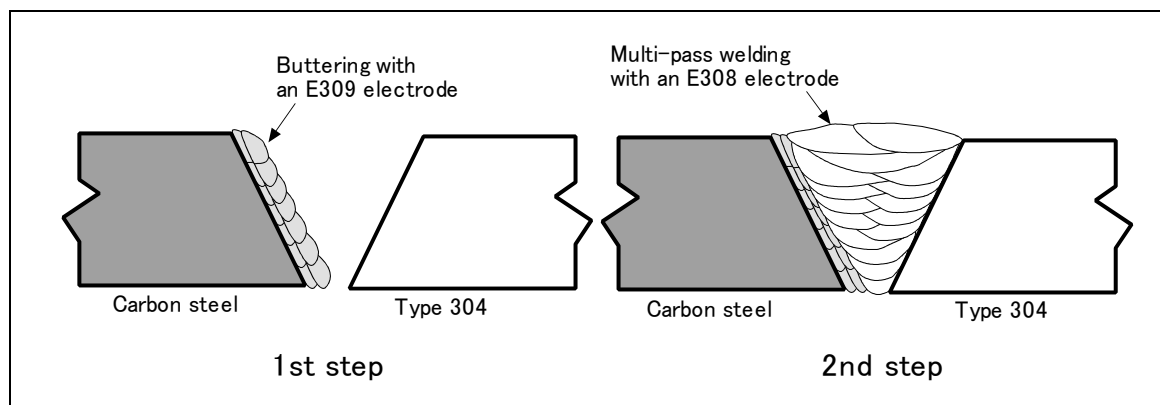

Fig. 4.10 — The buttering technique in welding of thick-section, dissimilar-metal joints to minimize the sigma-phase embrittlement

4.3.2 Welding of clad steels

The welding procedures for stainless clad steels should be appropriate to ensure the strength of the base steel and the corrosion resistance of the cladding stainless steel. **Table 4.2** shows typical welding consumables for welding various cladding stainless steels. The root pass welding of the cladding stainless steels is dissimilar-metal welding on the base steel of carbon steel or low-alloy steel. Therefore, a 309-, 309L- or 309LMo-type welding consumable should be used for the root pass of austenitic stainless steel claddings. For the second and subsequent passes, a welding consumable matching to the cladding steel should be used.

When a 309-type welding consumable is used for the root pass welding of Type 316 stainless steel, the required molybdenum content may not be achieved in the second pass. In such a case, a 309LMo-type welding consumable should be used for the root pass welding to ensure the molybdenum content.

When the cladding steel is Type 405 ferritic stainless steel, the root pass should be welded using a 430Nb-type welding consumable, and the second and subsequent passes should be welded with a 409Nb-type welding consumable. A 309-type welding consumable is also used for the equipment to be operated at temperatures below 400°C because thermal stresses are not so serious.

Table 4.2 — A quick guide to proper welding consumables for cladding stainless steels

Type of cladding steel	Pass sequence ⁽³⁾	Proper welding consumable	
		SMAW ⁽¹⁾	FCAW ⁽²⁾
304	1st layer	E309, E309L	E309T, E309LT
	2nd and subseq. layers	E308	E308T
304L	1st layer	E309L	E309LT
	2nd and subseq. layers	E308L	E308LT
316	1st layer	E309, E309L, E309LMo	E309T, E309LT, E309LMoT
	2nd and subseq. layers	E316	E316T
316L	1st layer	E309L, E309LMo	E316LT, E309LMoT
	2nd and subseq. layers	E316L	E316LT
321 347	1st layer	E309, E309L	E309T, E309LT
	2nd and subseq. layers	E347	E347T
405	1st layer	E430Nb	DW-430CbS
	2nd and subseq. layers	E409Nb	E409NbT

Note: (1) AWS A5.4:2012 (Stainless Steel Electrodes for Shielded Metal Arc Welding)

(2) AWS A5.22:2012 (Stainless Steel Flux Cored and Metal Cored Welding Electrodes and Rods)
 DW-430CbS is the trade designation of the specific brand produced by Kobe Steel.

(3) Pass sequence:

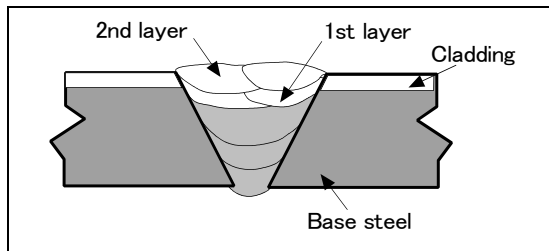

Table 4.3 shows typical procedures for welding stainless clad steels by flux cored arc welding (FCAW). The mark A in the table shows the welding procedure in which the cladding steel side is completed first. After that, back chipping is done before welding on the base steel side. The back chipping depth should be appropriate, otherwise, if it is excessively deep, the stainless steel weld metal may be exposed and the weld metal of the base steel side (4th pass in the figure) may pick up chromium and nickel from the stainless steel weld metal, causing hardening and cracking. The mark B in the table shows the welding procedure in which the base steel side is completed first. Subsequently, the cladding steel side is welded after back chipping. In this case, the root face of the base steel should be prepared so that the penetration of the root pass does not reach the cladding steel.

Table 4.3 — Welding procedures for stainless clad steels by using flux-cored wires

Mark	Groove preparation and pass sequence	Type of welding consumable	Welding conditions		
			DCEP current (A)	Arc voltage (V)	Travel speed (cm/min)
A		①④⑤: E71T-1 1.2 φ	200	28	30
		②: E309LMoT 1.6 φ	200	28	18
		③: E316LT 1.6 φ	200	28	18
B		①②③: E71T-1 1.2 φ	200	28	25
		④: E309LMoT 1.6 φ	200	28	22
		⑤: E316LT 1.6 φ	200	28	22

4.3.3 Overlay welding

In multi-layer overlay welding, the first layer can be referred to as dissimilar-metal welding, while the second and subsequent layers can be referred to as similar-metal welding, as in the welding of the cladding stainless steels. Hence, the first layer must be welded with a filler metal that can accommodate the base metal dilution. For the second and subsequent layers, a matching filler metal can be used. The filler metals listed in Table 4.2 are suitable also for overlay welding. In one-layer overlay welding, shallow penetration is a key factor to select a welding process to minimize the base metal dilution. ESW with strip electrodes is a typical process for this welding.

Table 4.4 shows various welding processes used for stainless steel weld overlaying and their features. The strip-electrode overlay process is the highest in the welding efficiency, but its application is limited to large parts with simple shapes such as the internal surfaces of the cylindrical work as shown in **Photo 4.3**. For strip-electrode overlaying, the strip width variations available are 25, 50, 75, and 150 mm; a wider strip can make higher efficiency. **Fig. 4.11** shows a magnetic control method of the molten pool for better bead appearance in ESW overlaying with a wide strip electrode.

Depending on the welding process, the penetration ratio (dilution ratio) differs. The penetration ratio can also vary with such welding parameters as welding current, arc voltage, travel speed, pass-to-pass overlapping size, preheating and interpass temperatures, and electrode extension. Therefore, these parameters should sufficiently be controlled during overlay welding. **Figs. 4.12** and **4.13** show how the penetration ratio can be affected by the welding parameters in shielded metal arc welding. The penetration ratio increases as the welding current and travel speed increase, or the pass-to-pass overlapping size decreases.

Table 4.4 — Various welding processes used for stainless steel weld overlaying

Welding process	Application	Features
Shielded metal arc welding (SMAW)	Wide scope of applications	(1) Dilution ratios are normally 15-20%. (2) Applicability is greater with a variety of welding electrodes, and no special device is needed.
Gas tungsten arc welding (GTAW)	<ul style="list-style-type: none"> • Internal surfaces of thin nozzles • Clad steels • End plates of heat exchangers 	(1) Dilution ratios are normally 10-20%. (2) For better control of penetration ratios, a mechanized welding process is desirable. (3) It is easier to deposit low carbon weld metals. (4) High-purity weld metals can be obtained.
Plasma arc welding (PAW)	<ul style="list-style-type: none"> • End plates of heat exchangers • Clad steels 	(1) Dilution ratios are less than 5% with DCEP currents. (2) With ordinary DCEN currents, dilution ratios are 5-10%. (3) For better control of penetration ratios, a mechanized welding process is desirable. (4) Welding efficiency can be improved by adopting an electricity-conveying filler wire or dual-feeding filler wire.
Gas metal arc welding (GMAW) with solid wires	<ul style="list-style-type: none"> • Internal surfaces of thin tubes and nozzles • End plates and flanges 	(1) With pulsed currents, penetration ratios are 20-30%. (2) For better penetration control, a mechanized welding process is indispensable. (3) The use of a high Si wire (ER309LSi) is desirable.
Flux cored arc welding (FCAW)	<ul style="list-style-type: none"> • Internal surfaces of thin tubes and nozzles • End plates and flanges • Clad steels 	(1) Penetration ratios are 20-30%. (2) Bead appearance can be smoother than in GMAW with solid wires. (3) For better penetration control, a mechanized welding process is desirable.
Strip electrode welding (SAW, ESW)	<ul style="list-style-type: none"> • Internal surfaces of pressure vessels • End plates 	(1) Penetration ratios are 15-20% in SAW, and 5-15% in ESW. (2) High welding efficiency

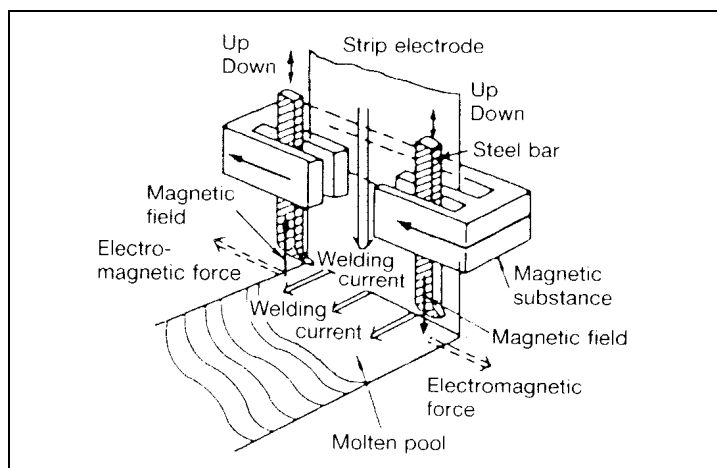
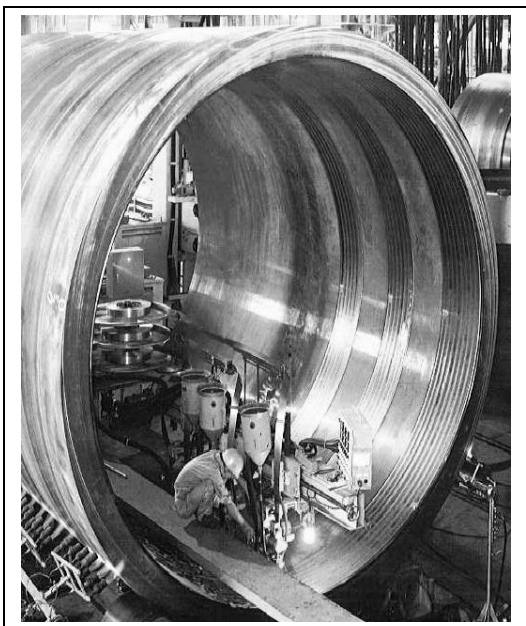

Photo 4.3 (Left) — Stainless steel weld overlaying of the internal surface of a pressure vessel by using a combination of strip electrode and flux

Fig. 4.11 (Above) — A magnetic control method for molten pool for better bead appearance in ESW overlaying with a 150-mm wide strip electrode

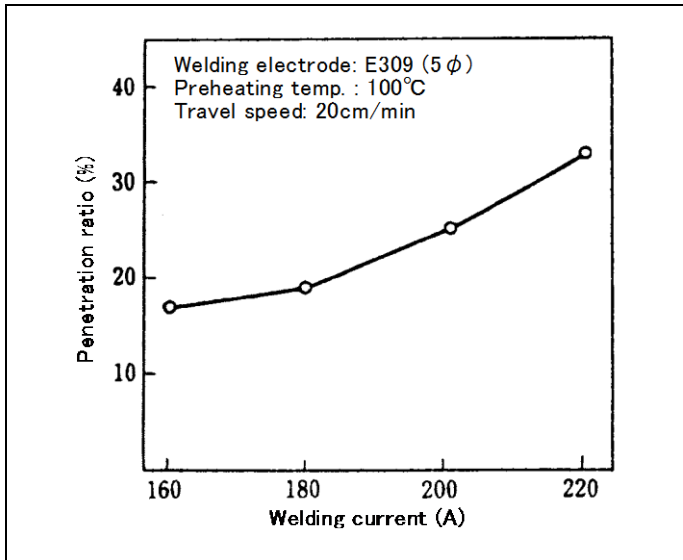
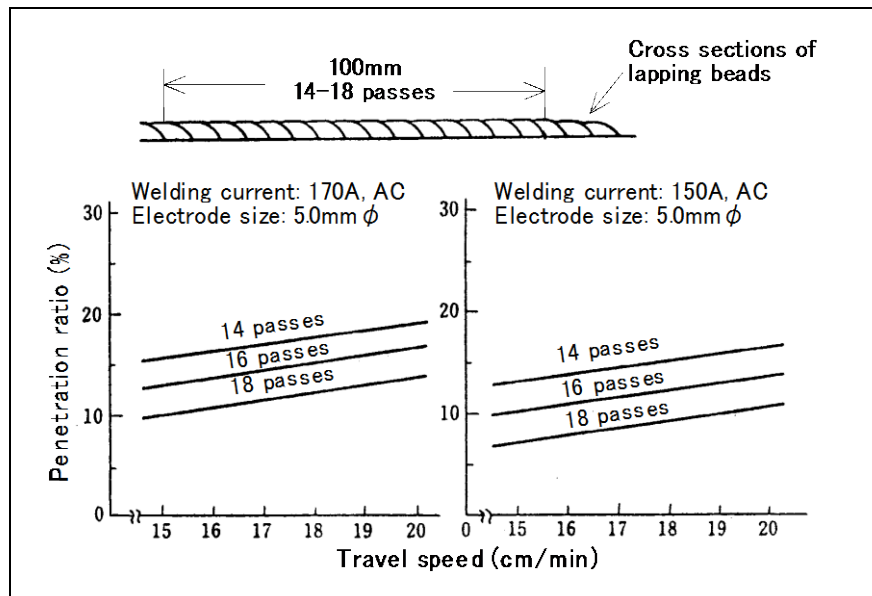

Fig. 4.12 — Penetration ratios as a function of welding current in bead-on-plate shielded metal arc welding

Fig. 4.13 — Penetration ratios as functions of travel speed and pass-to-pass overlapping size (pass numbers per 100-mm width) in bead-on-plate shielded metal arc welding



In stainless steel weld overlaying, postweld heat treatment (PWHT) is applied to reduce the hardness of the heat affected zone (HAZ) of the base metal as well as to remove residual stresses. On the other hand, PWHT causes creation of the decarburized zone and the carburized zone around the boundary zone between the base metal and the weld metal. The resultant precipitation of Cr carbide and sigma phase reduces the ductility and corrosion resistance of the weld. Therefore, PWHT temperature should be kept as low as possible. The lower limit of PWHT temperature recommended for the base metal should be adopted. When high-temperature long-hour PWHT is required for a pressure vessel with thick sections, it is necessary to examine carefully the chemical composition and ferrite content of the overlay weld metal to select the most suitable welding consumable.

5. Metallurgical properties and weldability of specialty stainless steels

This section discusses the metallurgical properties and weldability of the specialty stainless steels such as duplex stainless steel, high-nitrogen stainless steel, high-purity ferritic stainless steel, and precipitation-hardening stainless steel.

5.1 Duplex Stainless Steel

5.1.1 Metallurgical properties

As discussed in the previous section, austenitic stainless steel is widely used as structural steel materials because of its superior ductility, toughness and workability. On the other hand, it has such drawbacks as low yield strength and high sensitivity to stress corrosion cracking. In contrast, ferritic stainless steel features high yield strength and greater resistance to stress corrosion cracking, but it has low ductility and toughness and is prone to be embrittled. Accordingly, ferritic stainless steel is not used as structural steel materials. It can be said that these two types of stainless steels are opposite in their characteristics.

Duplex stainless steel has been developed as a material having the advantages of both austenitic and ferritic stainless steels. That is, duplex stainless steel combines the superior stress corrosion crack resistance of ferritic stainless steels with the good ductility, toughness and weldability of austenitic stainless steels. **Table 5.1** shows specifications for typical duplex stainless steels. A compositional balance of chromium, nickel, molybdenum and nitrogen characterizes duplex stainless steels with excellent corrosion resistance and the yield strength of approximately twice that of the 300-series alloys. Chemical plant machinery, oil and natural gas drilling pipes, pipelines, chemical tankers, and water gates are typical applications for duplex stainless steels.

Table 5.1 — Specifications for typical wrought duplex stainless steels

Wrought steel grade (Standard)	Chemical composition (%) ⁽¹⁾									Mechanical properties		
	C	Si	Mn	P	S	Ni	Cr	Mo	N	0.2%PS (N/mm ²)	TS (N/mm ²)	EI (%)
SUS 329J3L ⁽²⁾	0.030	1.00	2.00	0.040	0.030	4.50-6.50	21.00-24.00	2.50-3.50	0.08-0.20	450 min	620 min	18 min
UNS S31803 ⁽³⁾	0.030	1.00	2.00	0.030	0.020	4.5-6.5	21.0-23.0	2.5-3.5	0.08-0.20	450 min	620 min	25 min

Note: (1) Single values are maximum.

(2) JIS G 4304:2012 (Hot-Rolled Stainless Steel Plate, Sheet and Strip)

(3) ASTM A240/A240M-04a (Chromium and Chromium-Nickel Stainless Steel Plate, Sheet, and Strip for Pressure Vessels and for General Applications)

Duplex stainless steel has a binary microstructure consisting of normally 50% ferrite and 50% austenite. A typical microstructure of duplex stainless steel is included in **Photo 5.1** (see Page 3-49), which exhibits distributed austenite in the ferrite matrix. One of the advantages of the duplex stainless steel is the superior resistance to pitting corrosion and stress corrosion cracking in chloride-involved applications. **Fig. 5.1** shows the pitting potential of various stainless steels tested in the artificial seawater per ASTM-D-1141. The figure depicts that the pitting resistance increases with higher contents of Cr, Mo, and N. Nowadays, the Pitting Resistance Equivalent formula, $PRE = \%Cr + 3.3(\%Mo) + 16(\%N)$, is used as the pitting index to evaluate the resistance to pitting corrosion. The PRE values range from 24 for the leanest alloys to 40 or higher for super duplex alloys.

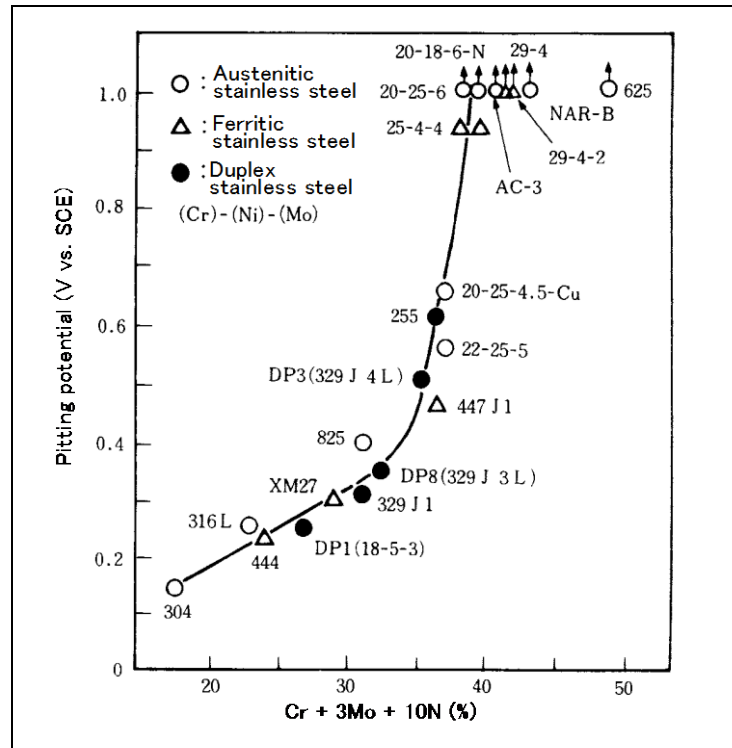

Fig. 5.1 — Pitting potential of various stainless steels as a function of the total amount of Cr, Mo and N as per the formula, $Cr+3Mo+10N$ (Data source: Preprint for 36th Forum on Corrosion Protection)

As mentioned above, higher yield strength is one of the advantages of duplex stainless steels over the 300- and 400-series stainless steels. **Table 5.2** compares the mechanical properties between austenitic, martensitic, ferritic and duplex stainless steels. The 0.2% yield strength of Type S31803 is more than double the strength of Type 304, and the tensile strength is also higher. This feature facilitates higher design stresses for duplex stainless steels, which in turn can reduce the plate thickness of the equipment designed.

Table 5.2 — A comparison of specified mechanical properties of wrought stainless steels per ASTM A240-04a

Type of stainless steel	0.2% proof strength (MPa)	Tensile strength (MPa)	Elongation (%)
Austenitic (304)	205 min	515 min	40 min
Martensitic (410)	205 min	450 min	20 min
Ferritic (430)	205 min	450 min	22 min
Duplex (S31803)	450 min	620 min	25 min

The notch toughness of duplex stainless steels is better than that of ferritic stainless steels, as shown in **Fig. 5.2**. However, the toughness decreases sharply as the testing temperature decreases. Duplex stainless steels, therefore, are not suitable for cryogenic applications. The coefficient of thermal expansion, thermal conductivity and other physical properties of duplex stainless steels fall in between those of the ferritic and austenitic stainless steels.

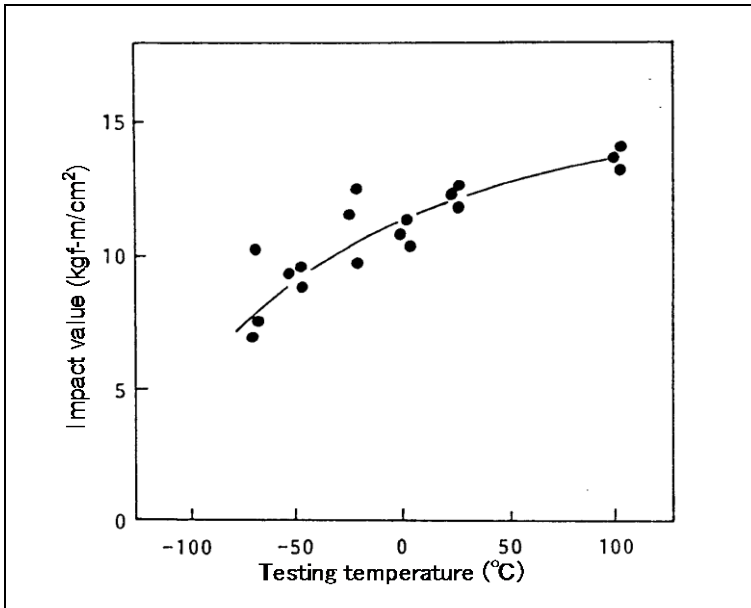

Fig. 5.2 — Impact notch toughness of duplex stainless steels
 (1 kg-m/cm² = 9.8 J/cm²)

5.1.2 Weldability

Duplex stainless steels are relatively resistant to hot cracking but are little inferior to conventional austenitic stainless steels according to the Spot Vareststraint test results shown in Fig. 5.3. The hot crack resistance of the duplex stainless steel weld metal evaluated by the total crack length is little inferior to the 308L- and 316L-type weld metals containing a few percent of ferrite. However, it is far better than that of the fully austenitic weld metals of 310-type stainless steel and 625-type nickel alloy. Duplex stainless steel can, therefore, be considered to have sufficient weldability in terms of hot cracking. The hot cracking susceptibility, however, is affected by such welding conditions as welding current and travel speed. Fig. 5.4 shows the transitional welding conditions that separate the cracking zone and no-cracking zone of the weld metals in flux-cored arc welding with an AWS E2209T wire. This figure suggests that both welding current and travel speed must be controlled low to prevent the hot cracking in thick section root passes.

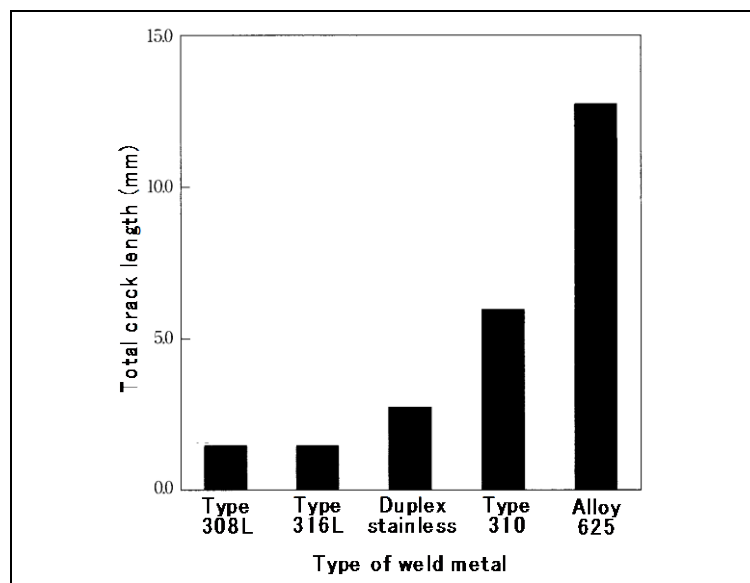

Fig. 5.3 — A comparison between various types of SMAW weld metals on hot crack susceptibility obtained by the Spot Vareststraint test under external loading for imposing plastic deformation in the testing weld

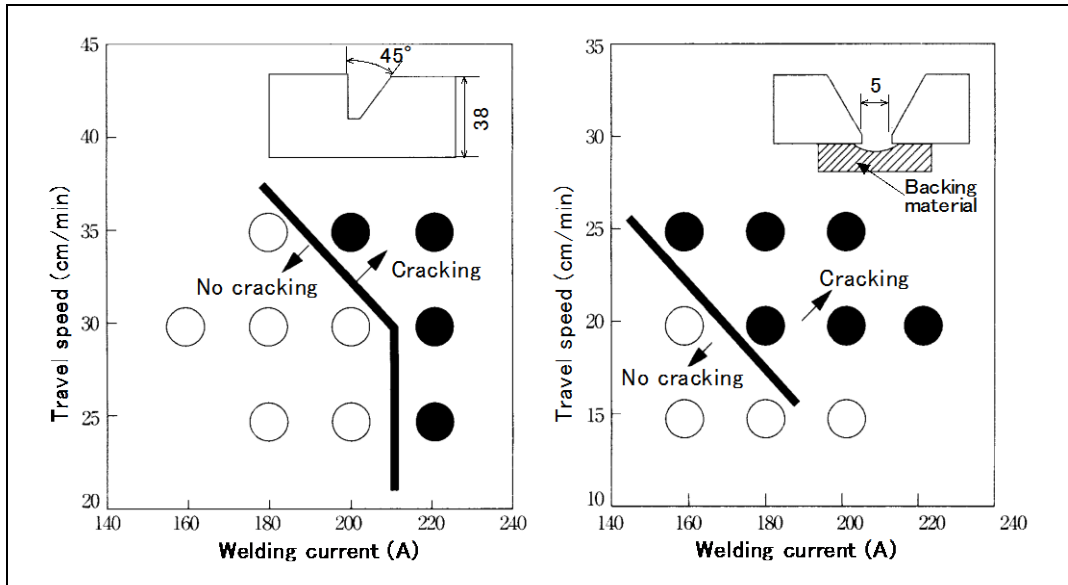

Fig. 5.4 — Hot crack susceptibility of an AWS E2209T duplex stainless steel weld metal tested in the root pass of a thick plate

With respect to the resistance to cold cracking, the diffusible hydrogen content of weld metals is an essential factor in general. **Table 5.3** shows test results of measurement of the hydrogen evolved from duplex stainless steel weld metals. The test data show very low amounts of diffusible hydrogen when compared with ordinary carbon steel weld metals. This is because the diffusion rates of hydrogen in duplex stainless steel weld metals, as in other high alloy weld metals, are extremely low. For another reason, the austenite phase of duplex stainless steel weld metals has relatively high hydrogen solubility. In the window-type restraint cracking tests with 50-mm thick plates and a 25Cr-9Ni-3Mo-N covered electrode (NC-329M) without preheating, no cold cracking occurred in the multiple-pass welds. In addition, the welding of a chemical tanker that was made of 35-mm thick duplex stainless steel plates was successfully accomplished without preheating by using AWS E2209T flux-cored wires of DW-329A and DW-329AP. These facts suggest that these duplex stainless steel filler metals have sufficient cold crack resistibility.

Table 5.3 — Test results of measurement of the hydrogen evolved from duplex stainless steel weld metals

Welding process	Brand ⁽¹⁾ (Standard class.)	Shielding gas	Diffusible hydrogen (cc/100g)	Condition of welding consumables
SMAW	NC-329M (JIS ES329J4L-16)	—	< 0.1	Right after redrying
FCAW	DW-329A (AWS E2209T0-1/-4)	100%CO ₂	0.43	Right after unpacked
		80%Ar+20%CO ₂	0.53	Right after unpacked
		100%CO ₂	0.50	1 week later since unpacked
		80%Ar+20%CO ₂	0.58	1 week later since unpacked

Note: (1) Supplied from Kobe Steel.

In the girth welding of duplex stainless steel pipes by GTAW welding with a pure argon shielding gas, it must be noted that a compositionally matching filler rod may be insufficient in corrosion resistance. This can be attributed to the following facts. First, the nitrogen contained in the filler rod cannot fully be transferred into the weld metal in the pure argon

atmosphere, which results in a weld metal containing lower nitrogen than the formulated. Second, the root pass weld metal tends to be diluted markedly by the base metal, which in turn may cause an unstable austenite-ferrite microstructure. Finally, the root pass weld is prone to precipitate carbide, nitride, and sigma phase, thereby causing degradation of corrosion resistance. In order to prevent the degradation of corrosion resistance, one measure is to use an argon shielding gas containing a few percent (1-2%) of nitrogen. Another measure is to use a filler rod having a higher PRE value. **Table 5.4** shows the corrosion test results of duplex stainless steel weld joints made by using the welding procedure shown in **Table 5.6** with three different types of filler rods as shown in **Table 5.5**. As indicated in **Table 5.4**, the pitting corrosion was observed on the surface of the root pass weld with the filler rod (A) that matches the base metal in chemical composition. However, the filler rod (B) of higher-PRE duplex stainless steel and the filler rod (C) of super duplex stainless steel did not exhibit pitting corrosion on the surfaces of the root pass welds.

Table 5.4 — Pitting corrosion test results of duplex stainless steel welds (Testing method: ASTM G48)

Filler rod	25°C × 24hr			30°C × 24hr		
	Corrosion loss (g/m ² -hr)	Pitting corrosion	Location of pitting corrosion	Corrosion loss (g/m ² -hr)	Pitting corrosion	Location of pitting corrosion
(A)	2.19	Yes	Root pass bead	5.05	Yes	Root pass bead
(B)	0.06	No	—	1.47	Yes	Base metal HAZ
(C)	0.05	No	—	0.83	Yes	Base metal HAZ

Note: For the latest information of the pitting corrosion test method, refer to ASTM G48-11 (Standard Test Methods for Pitting and Crevice Corrosion Resistance of Stainless Steels and Related Alloys by Use of Ferric Chloride Solution)

Table 5.5 — Typical chemical composition of the filler rods and base metal for the corrosion test

Filler rod	Chemical composition of filler rod and base metal (%)									
	C	Si	Mn	P	S	Ni	Cr	Mo	N	PRE
(A)	0.015	0.44	1.83	0.023	0.003	9.71	22.21	2.78	0.19	34.4
(B) (TG-S329E)	0.013	0.72	0.49	0.020	0.001	7.13	24.82	3.16	0.15	37.6
(C)	0.017	0.37	0.45	0.015	0.001	9.46	24.80	3.89	0.27	42.0
Base metal (S31803) 20mm	0.016	0.56	1.55	0.020	0.001	6.09	22.21	2.92	0.15	34.2

Note: PRE = Cr + 3.3Mo + 16N.

Table 5.6 — Welding conditions for the duplex stainless steel weld joints for the corrosion test

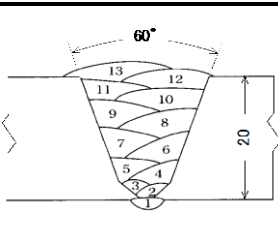
Groove preparation and pass sequence	Welding process	Pass No.	Filler rod and wire	Welding current (A)	Arc voltage (V)	Travel speed (cm/min)	Heat input (kJ/cm)	Shielding gas
	GMAW	1	(A), (B), (C)	110	12	2.0-2.2	36-39	100%Ar (15 l/min)
		2-3		160	13	6.0	16.5	
	FCAW	4-5	DW-329A (AWS E2209T)	180	28	34.0	8.9	80%Ar+20%CO ₂ (25 l/min)
		6-7		200	29	32.0	10.9	
		8-13		200	29	30.0	11.6	

Note: Welding position is flat and interpass temperature is 100-150°C.

Heat input is one of the essential factors that affect the corrosion resistance of duplex stainless steel welds. This is because the balance of ferrite and austenite of the microstructure can vary affected by heat input. **Photo 5.1** shows typical microstructures of the unaffected zone, heat-affected zone, fusion zone, and weld metal of a S31803 duplex stainless steel weld joint.

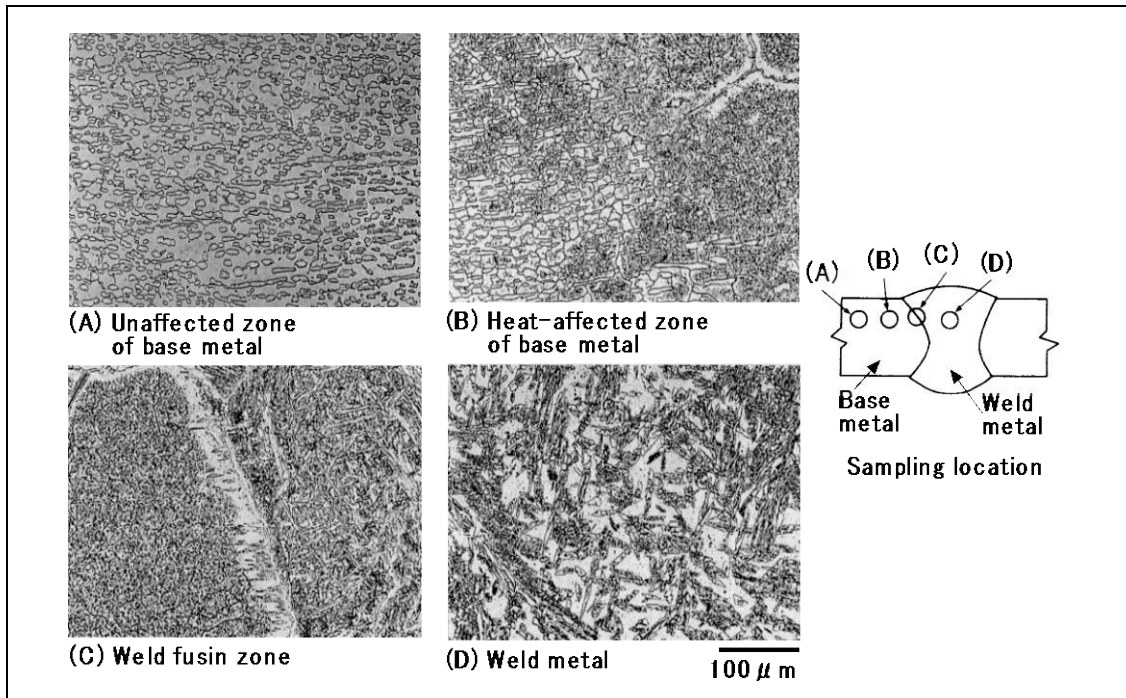

Photo 5.1 — The unaffected zone of a S31803 base metal (A) consists of distributed austenite and the ferrite matrix. The heat-affected zone of a S31803 base metal (B) may precipitate sigma phase, carbide, and nitride in the austenite-ferrite binary structure. The fusion zone of an S31803 base metal (C) precipitates a coarse ferrite zone in the vicinity of the fusion line. The weld metal (D) shows an as-cast austenite-ferrite binary structure quite different from that of the wrought base metal, which was deposited with an E2209T-type flux-cored wire.

The use of excessively low heat input — thus excessively high cooling speed — restricts, on cooling, the precipitation of austenite in the ferrite matrix in the vicinity of the fusion line that was heated over 1350°C by the heat of arc. Consequently, the carbon and nitrogen contained in the base metal are also restricted to dissolve in the austenite due to an excessively high cooling speed, and thus they precipitate to become nitride (CrN) and carbide ($M_{23}C_6$), which in turn cause the formation of chromium-depleted zones, thereby degrading the corrosion resistance of the weld. Therefore, in this sense, the heat input should be higher to decrease the cooling speed, thereby helping the austenite precipitate in the ferrite matrix. On the other hand, the heat-affected zone heated in the 700-900°C range is prone to precipitate sigma phases, carbides and nitrides when the cooling speed is low. These precipitation causes degradation in corrosion resistance and notch toughness. In this sense, the heat input should be low to increase the cooling speed of the heat-affected zone, in contrast to the case of the fusion zone mentioned above.

After all, these facts suggest that the heat input should not be excessively high or low to provide welds with sufficient corrosion resistance, as shown in **Fig.5.5**.

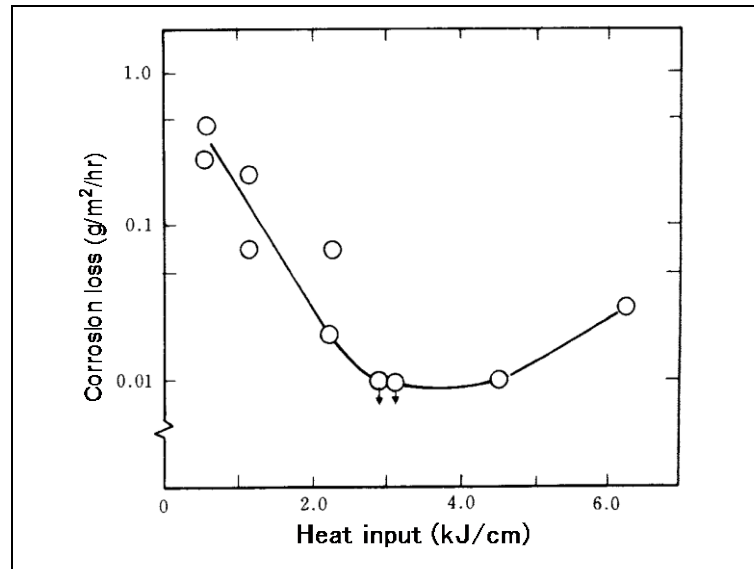

Fig. 5.5 — Effect of heat input on the pitting corrosion resistance of duplex stainless steel welds
 (Data source: Proc. Conf. “Corrosion 86,” NACE)

Duplex stainless steel weld metal exhibits, as shown in Photo 5.1, a relatively ununiform austenite-ferrite binary structure compared with the base metal. The ununiform microstructure exhibits inherently inferior corrosion resistance when compared with that of the base metal. In order to overcome this drawback, the weld metals are formulated by adding higher amounts of alloying elements. Namely, duplex stainless steel weld metals contain a higher percent of nickel as compared with the base metals in order to facilitate a balanced structure with 50% ferrite and 50% austenite in the as-welded condition. For estimation of the ferrite content of duplex stainless steel weld metals, a WRC-1992 diagram as shown in Fig. 2.5 (see Page 3-8) is applicable.

Table 5.7 shows the typical chemical and mechanical properties of deposited metals by SMAW, FCAW, and GTAW with the latest Kobe Steel’s brands suitable for duplex stainless steel of UNS S32205, S31803, etc.

Table 5.7 — Typical chemical and mechanical properties of filler metals for duplex stainless steel

Welding process	Brand (AWS class.) ⁽³⁾	Chemical composition of deposited metal or wire (%) ⁽¹⁾							
		C	Si	Mn	Ni	Cr	Mo	N	PRE ⁽²⁾
SMAW	NC-2209 (A5.4 E2209-16)	0.03	0.47	1.1	9.0	23.2	3.2	0.17	36.5
FCAW	DW-2209 (A5.22 E2209T1-1/-4)	0.03	0.5	0.7	9.4	23.0	3.3	0.14	36.1
GTAW	TG-S2209 (A5.9 ER2209)	0.01	0.38	1.49	8.6	23.0	3.3	0.15	36.3
Welding process	Brand (AWS class.)	Tensile properties			Impact properties				
		0.2% proof strength (MPa)	Tensile strength (MPa)	Elongation (%)	Charpy I.V. (J)				
					-40°C	-50°C			
SMAW	NC-2209 (A5.4 E2209-16)	667	845	30	—	72			
FCAW	DW-2209 (A5.22 E2209T1-1/-4)	630	815	28	60	—			
GTAW	TG-S2209 (A5.9 ER2209)	615	814	38	—	150			

Note: (1) For GTAW, chemical composition is for wire.

(2) PRE = Cr + 3.3Mo + 16N.

(3) AWS A5.4:2012, A5.9:2006, A5.22:2012

5.2 High-nitrogen stainless steel

5.2.1 Metallurgical properties

With high-nitrogen austenitic stainless steels produced by adding nitrogen, the plate thickness can be decreased in the designing of equipment due to the benefit of higher tensile strength. Nitrogen-added austenitic stainless steel is used for high-temperature applications as well as for ambient-temperature applications. Nowadays, such applications are expanding to cryogenic equipment. The JIS standard specifies SUS304N1, 304N2, 304LN, 316N, 316LN, and 317LN for this type of stainless steel. **Table 5.8** shows the specified chemical composition and mechanical properties of typical high-nitrogen stainless steels.

Table 5.8 — Chemical composition and mechanical properties of high-nitrogen stainless steels

Type of steel	C	Si	Mn	Ni	Cr	Mo	N	Nb	0.2% P.S. (N/mm ²)	T.S. (N/mm ²)	El (%)
304N2	0.08 max	1.00 max	2.50 max	7.50-10.50	18.00-20.00	—	0.15-0.30	0.15 max	345 min	690 min	35 min
304LN	0.030 max	1.00 max	2.00 max	8.50-11.50	17.00-19.00	—	0.12-0.22	—	245 min	550 min	40 min
316LN	0.030 max	1.00 max	2.00 max	10.50-14.50	16.50-18.50	2.00-3.00	0.12-0.22	—	245 min	550 min	40 min

Note: JIS G 4304-2012 (Hot Rolled Stainless Steel Plates, Sheets and Strips)

The addition of nitrogen in austenitic stainless steels can increase both tensile strength and 0.2% proof strength. The effect of nitrogen on the strength of austenitic stainless steels can be expected in a wide temperature range including cryogenic and elevated temperatures. In particular, the effect at cryogenic temperatures is significant as shown in **Fig. 5.6**. The addition of nitrogen can also increase creep rupture strength. **Fig. 5.7** shows the effect of nitrogen on the 1000-hour creep rupture strength of Type 316L steel. Remarkable effect is observed when nitrogen content is 0.12% or lower and temperature is lower than 650°C.

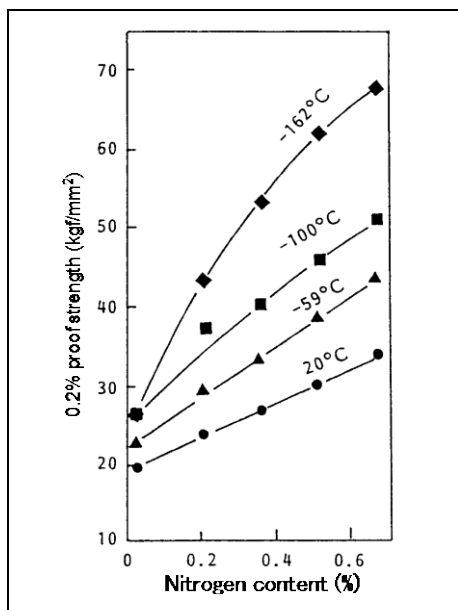

Fig. 5.6 — Effect of nitrogen on 0.2% proof strength of 18Cr-15Ni steel (1 kgf/mm² = 9.8 MPa)

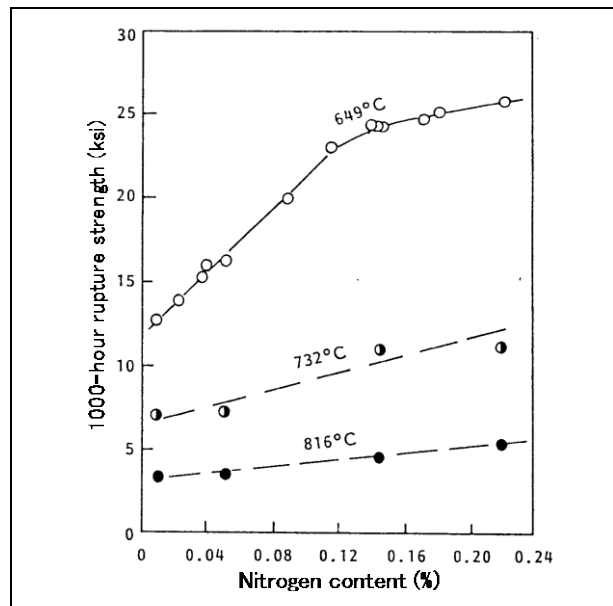

Fig. 5.7 — Effect of nitrogen on creep rupture strength of Type 316L steel (1 ksi = 6.9 MPa)

The pitting corrosion resistance can also be improved with addition of nitrogen. The use of 316LN- and 317LN-type steels for chemical tankers is increasing. Type 304N2 is used for architectural structures and machinery parts. These are attempts to reduce plate thickness or, contrary, increase the design strength of equipment by increasing the strength of the steel components, and improve corrosion resistance.

5.2.2 Weldability

The nitrogen contained in high-nitrogen austenitic stainless steels affects the weldability of the steel. **Fig. 5.8** shows the adverse effect of nitrogen on the occurrence of porosity in 308-type weld metals. The number of blowholes increases sharply when the nitrogen content exceeds 0.2%. Although the solubility of nitrogen in stainless steel weld metals can vary with the chemical composition, it is believed to be around 0.20%. The sharp increase in the number of blowholes as shown in Fig. 5.8 may have been caused by the amount of nitrogen exceeding the soluble range in the 308-type weld metal.

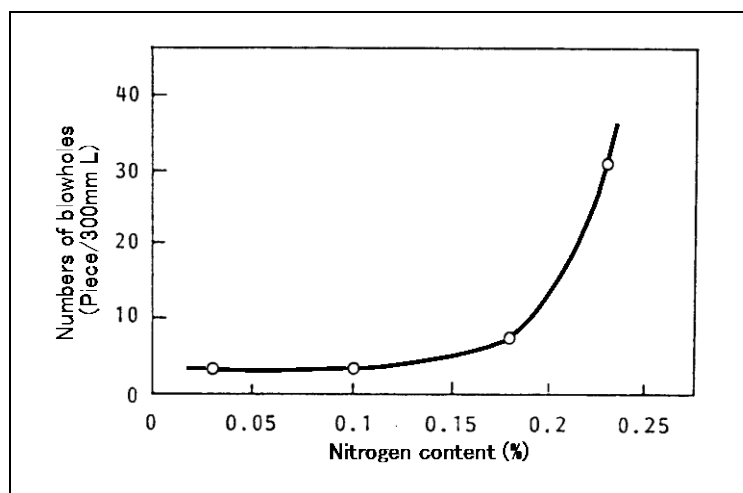

Fig. 5.8 — Effect of nitrogen content of 308-type weld metals on the occurrence of blowholes

The addition of nitrogen increases the strength and pitting corrosion resistance of the weld metals. **Fig. 5.9** shows the relationship between the nitrogen content and mechanical properties of 308-type weld metals. The tensile strength and 0.2% proof strength of the weld metal increase with an increase in the nitrogen content. **Fig. 5.10** shows the pitting corrosion loss of 308-type weld metals as a function of nitrogen content. Clearly, the resistance to pitting corrosion increases with an increase in the nitrogen content. For the latest information of the testing method, refer to JIS G 0578:2000 (Method of Ferric Chloride Tests for Stainless Steels).

Nitrogen is a strong austenite-forming element; therefore, the ferrite content of weld metals decreases as the nitrogen content increases. With extremely low ferrite or fully austenitic weld metals, the sensitivity to hot cracking of the weld metal increases. To prevent hot cracking, the welding consumables suitable for high-nitrogen stainless steels are formulated, with appropriate amounts of nickel and chromium, so that the weld metal will contain an appropriate amount of ferrite. **Table 5.9** shows the typical chemical composition and mechanical properties of deposited metals of flux-cored wires suitable for high-nitrogen austenitic stainless steels. DW-317L and DW-317LP contain no nitrogen but matches the base metal in terms of tensile strength and the corrosion resistance, compensated by molybdenum.

Fig. 5.9 — Effect of nitrogen content of 308-type weld metals on tensile strength and 0.2% proof strength (1 kgf/mm² = 9.8 MPa)

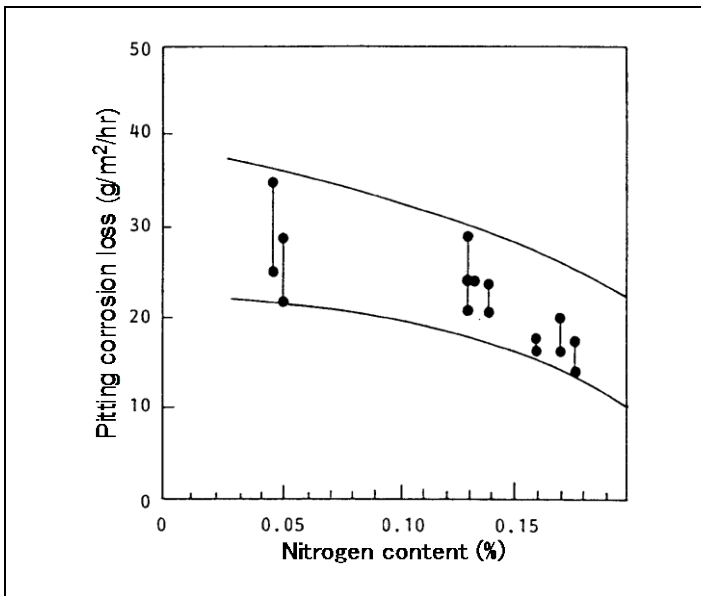
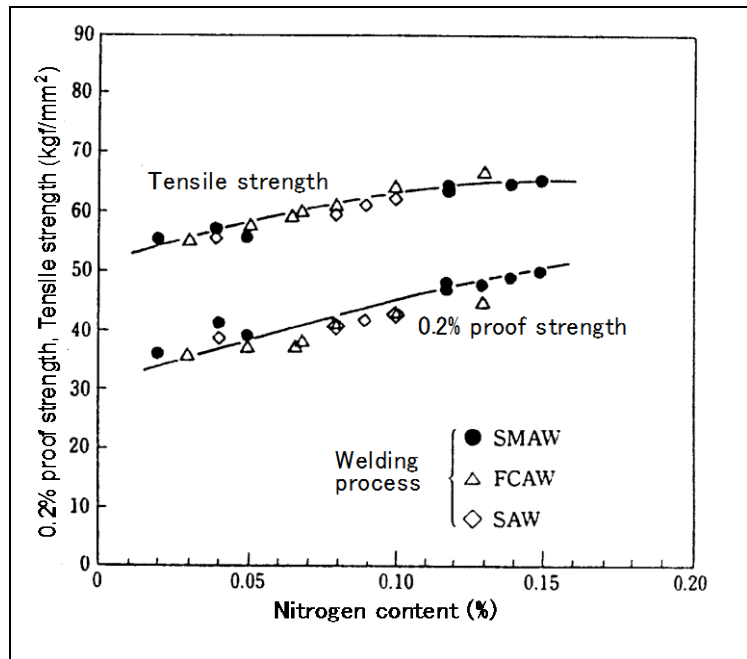

Fig. 5.10 — Effect of nitrogen content of 308-type weld metals on the corrosion loss in the pitting test per JIS G 0578 at 35°C

Table 5.9 — Typical chemical composition and mechanical properties of deposited metals of flux-cored wires suitable for N-bearing high-strength austenitic stainless steels

JIS Steel grade ⁽¹⁾	Suitable FCW ⁽²⁾	Filler metal class. ⁽³⁾	Chemical composition of deposited metal (%)							0.2% P.S. (MPa)	T.S. (MPa)
			C	Si	Mn	Ni	Cr	Mo	N		
304LN	DW-308LN	—	0.03	0.5	1.4	9.3	21.5	—	0.09	430	610
304N2	DW-308N2	JIS TS308N2-FBO	0.08	0.7	1.5	7.9	21.8	—	0.13	520	710
316LN	DW-317L	AWS E317LT0-1/4	0.03	0.4	1.0	12.8	18.9	3.1	—	380	590
	DW-317LP	AWS E317LT1-1/4	0.03	0.6	1.3	13.8	18.6	3.3	—	435	582

Note: (1) JIS G 4304:2012 (Hot Rolled Stainless Steel Plates, Sheets and Strips)

(2) Supplied from Kobe Steel.

(3) JIS Z 3323:2007 (Stainless Steel Flux Cored Wires and Rods for Arc Welding)

AWS A5.22: 2012 (Stainless Steel Flux Cored and Metal Cored Welding Electrodes and Rods)

5.3 High-purity ferritic stainless steel

5.3.1 Metallurgical properties

High-purity ferritic stainless steel is distinguished from the ordinary ferritic stainless steel by its low carbon, nitrogen and other impurities. Such advanced quality has been attained by the progress of steel-refining techniques such as vacuum melting or vacuum decarburization. This type of ferritic stainless steel has greater notch toughness compared with the ordinary ferritic stainless steel of Type 430. As shown in **Fig. 5.11**, the decreases in the carbon and nitrogen content can markedly improve notch toughness.

High-purity ferritic stainless steel features 16% or higher chromium content. Most of them also contain 1-2% molybdenum to improve corrosion resistance in chlorine-ion environments. Many types of high-purity ferritic stainless steels contain small amounts of niobium and titanium to stabilize residual carbon and nitrogen by forming carbonitrides, thereby preventing the formation of chromium carbides. **Table 5.10** shows the chemical composition and mechanical properties of typical high-purity ferritic stainless steel. High-purity ferritic stainless steel has superior resistance to the stress corrosion cracking in a chlorine-ion environment which is most corrosive to austenitic stainless steels.

Table 5.10 — Chemical composition and mechanical properties of typical high-purity ferritic stainless steel

Steel grade	Chemical composition (%)									0.2% P.S. (N/mm ²)	T.S. (N/mm ²)	EI (%)
	C	Si	Mn	P	S	Cr	Mo	N	Ti+Nb+Zr			
SUS444	0.025 max	1.00 max	1.00 max	0.040 max	0.030 max	17.00 -20.00	1.75 -2.50	0.025 max	8 x (C+N) -0.80	245 min	410 min	20 min

Note: JIS G 4304-2012 (Hot Rolled Stainless Steel Plates, Sheets and Strips)

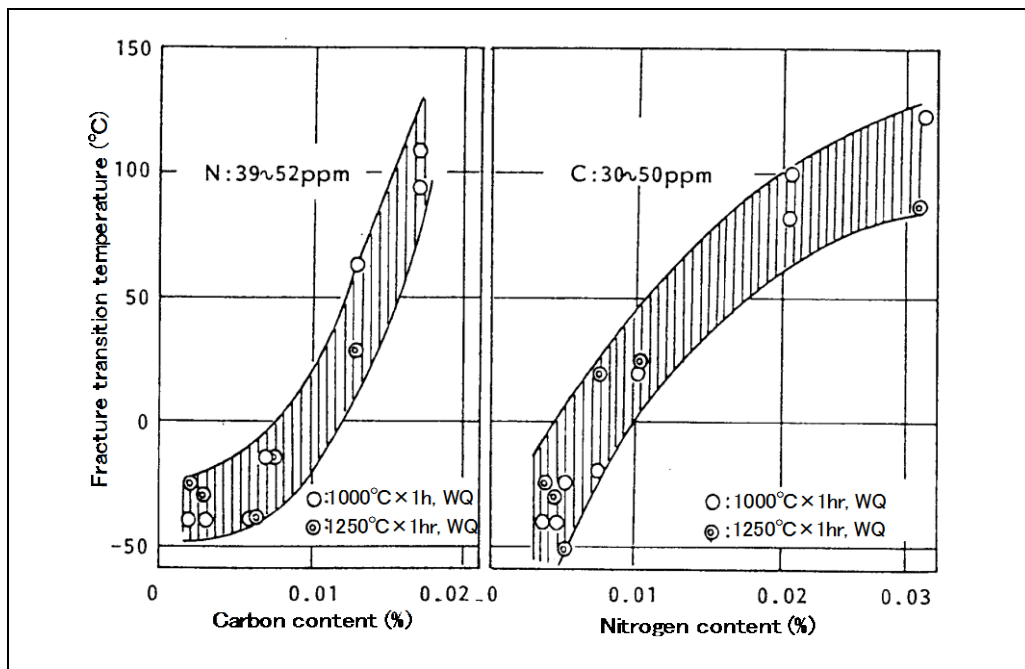

Fig. 5.11 — Effects of carbon and nitrogen contents of ferritic stainless steels on notch toughness

5.3.2 Weldability

For welding high-purity ferritic stainless steels, a compositionally matching filler metal should be of high purity with low amounts of carbon, nitrogen and oxygen. Therefore, suitable welding processes are TIG and MIG by which low-carbon low-oxygen weld metals can be obtained more easily. However, the weld metal matching to the base metal exhibits poor notch toughness due to the difficulty of reducing the carbon content below 0.010% and inherent coarse grains. Because of these reasons, a compositionally matching filler metal is not used in common. Instead, 316L- and 309LMo-type filler metals are commonly used for welding high-purity ferritic stainless steels.

The heat-affected zone of the base metal tends to exhibit markedly coarse grains. As shown in **Photo 5.2**, the microstructure of the heat-affected zone of a MIG-welded 444-type base metal (4-mm thick) exhibits significantly coarse grains in the vicinity of the fusion line. Therefore, it is necessary to keep the welding heat input as low as possible to prevent such coarse grains.

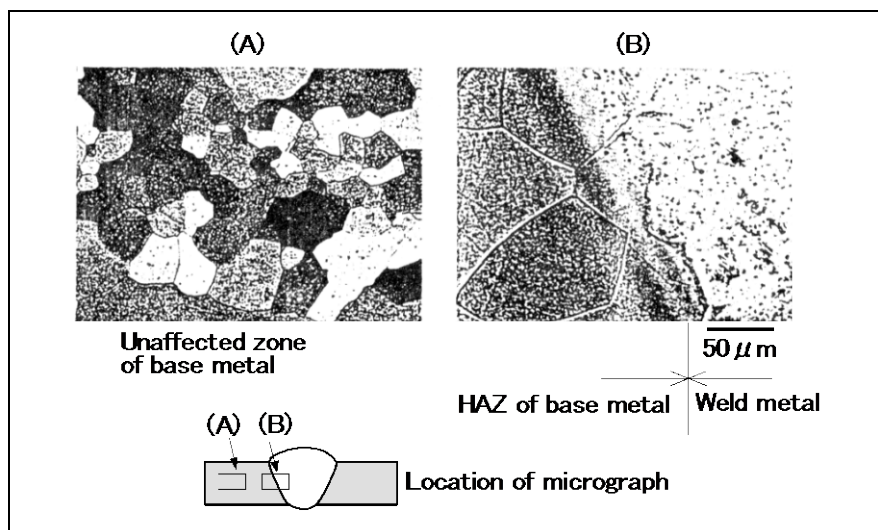

Photo 5.2 — Microstructures of SUS444 base metal and 316L-type MIG weld metal

5.4 Precipitation-hardening stainless steel

Precipitation-hardening stainless steel offers high strength, containing precipitates of copper, aluminum, molybdenum, titanium and niobium that increase strength while maintaining high corrosion resistance. Precipitation-hardening stainless steel has the following features.

- (1) Good workability in the solid solution condition facilitates easier forming.
- (2) High strength can be obtained by the precipitation hardening heat treatment (aging).
- (3) The corrosion resistance is comparable to the ordinary stainless steels.

Precipitation-hardening stainless steels are grouped into four types depending on the structure and behavior of the steel when it is cooled from the appropriate austenitizing temperature: martensitic, semi-austenitic, austenitic, and austenite-ferritic types.

Among the precipitation hardening stainless steels specified in the JIS standard, a martensitic grade of SUS630 is commonly used. **Table 5.11** shows the specified chemical composition of SUS630 grade steel.

When subjected to the precipitation hardening heat treatment (aging treatment) in the 370-600°C range after solution treatment, SUS630 grade steel increases hardness as shown in **Table 5.12**. The hardness of the steel is markedly affected by the aging temperature. This suggests that accurate control of the aging temperature is necessary to control the hardness.

SUS630 grade steel has comparatively good weldability, which can use shielded metal arc welding and TIG welding. However, the relatively high notch sensitivity of the steel requires sufficient care, in welding procedures, not to cause undercut and other welding defects. In the welding of SUS630 grade steel, the matching welding consumables are used. **Table 5.13** shows the typical chemical composition and mechanical properties of the matching weld metals after being solution heat treated and aged.

Table 5.11 — Specified chemical composition (%) of SUS630 hot rolled stainless steel (JIS G 4304-2012)

C	Si	Mn	P	S	Ni	Cr	Cu	Nb
0.07 max	1.00 max	1.00 max	0.040 max	0.030 max	3.00- 5.00	15.00- 17.50	3.00- 5.00	0.15- 0.45

Table 5.12 — Effect of the aging temperature on mechanical properties of SUS630 stainless steel

Heat treatment Mechanical properties	Solution treatment (1040°C)	Aging temperature after solution treatment (°C)				
		480	495	550	580	620
Tensile strength (MPa)	1100	1450	1380	1270	1210	1100
0.2% proof strength (MPa)	1000	1380	1340	1170	1140	1030
Elongation (%)	5.0	7.0	8.0	8.0	8.0	11.0
Hardness (HRC)	33	45	43	38	37	33

Table 5.13 — Typical chemical compositions and mechanical properties of SMAW and TIG deposited metals for SUS630 grade steel⁽¹⁾

Welding process	Filler metal (AWS class)	Chemical composition (%)									0.2% P.S. (MPa)	T.S. (MPa)	EI (%)
		C	Si	Mn	P	S	Ni	Cr	Cu	Nb			
SMAW	NC-630 (A5.4 E630)	0.04	0.49	0.45	0.009	0.003	4.85	16.34	3.64	0.21	930	990	20
TIG	TG-S630 (A5.9 ER630)	0.04	0.40	0.42	0.008	0.004	4.71	16.51	3.56	0.18	1030	1100	15

Note: (1) Solution and aging treatments: 1050°C × 30min (AC) followed by 470°C × 4hr (AC) for SMAW
1030°C × 1hr (AC) followed by 550 × 4hr (AC) for TIG

Arc Welding of Cast Iron

Contents

1. Types and features of cast iron	4-2
1.1 Gray cast iron	4-3
1.2 Ductile cast iron	4-4
1.3 White cast iron	4-5
1.4 Malleable cast iron	4-5
2. Weldability of cast iron in fusion welding	4-6
2.1 Common problems in weldability	4-6
2.2 Effects of graphite form on weldability	4-8
3. Welding processes	4-8
3.1 Shielded metal arc welding	4-8
3.2 Gas shielded metal arc welding	4-8
3.3 Gas tungsten arc welding	4-9
3.4 Submerged arc welding	4-9
4. Welding consumables	4-9
4.1 Types and classifications	4-9
4.2 Typical covered electrodes for SMAW	4-10
5. Welding procedures	4-12
5.1 Groove preparation	4-12
5.2 Preheat	4-12
5.3 Postweld heat treatment	4-15
5.4 Deposition methods	4-17
5.5 Peening	4-18
5.6 Studding and cramping	4-20
5.7 Patching	4-21

1. Types and features of cast iron

Irons that contain 2.0-6.67% carbon are called cast iron. However, the cast iron used for industrial general purposes contains 2.0-4.5% carbon, 1-3% silicon, and manganese. Alloy cast iron may also contain other elements deliberately added to provide desired properties such as strength, hardness, hardenability, or corrosion resistance for specific applications. Common alloying elements are chromium, copper, molybdenum, and nickel. All of these different types of cast iron can be subdivided as shown in **Figs. 1.1** and **1.2**, which give relevant British, American, and Japanese standards for reference but not for precise equivalence.

+

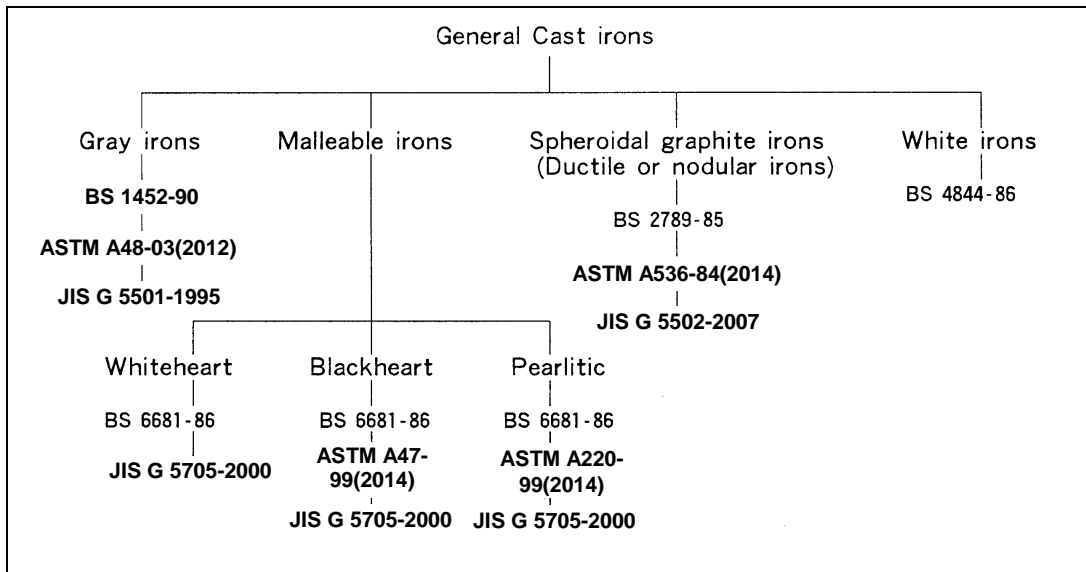

Fig. 1.1 — Classification of general cast iron (Source bef. update: Metal Construction)

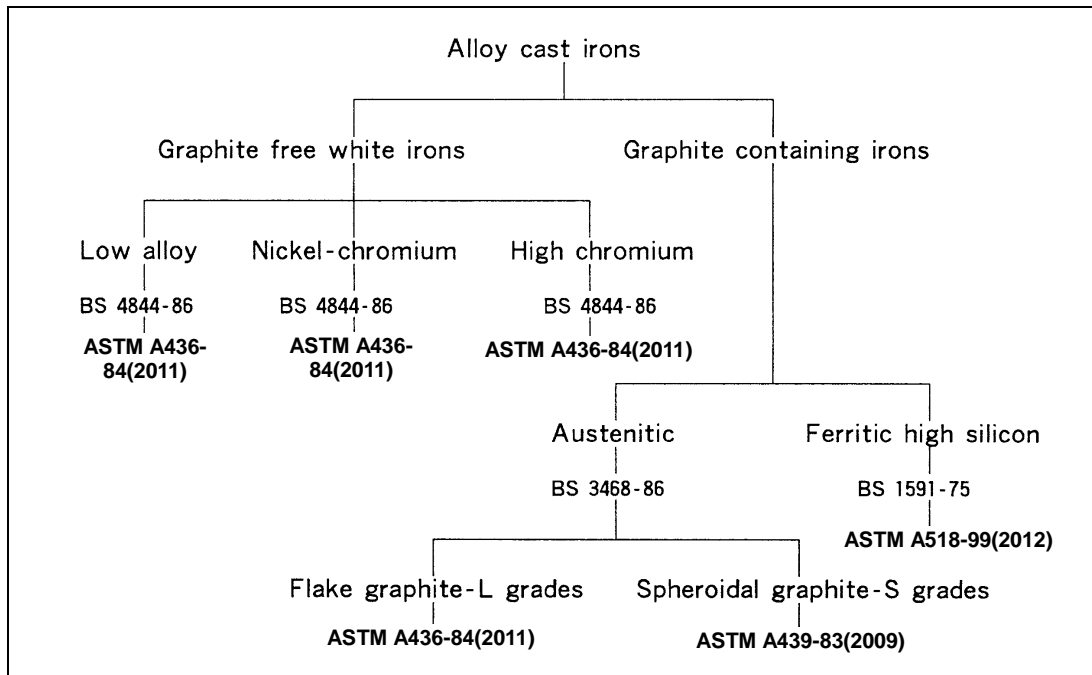

Fig. 1.2 — Classification of alloy cast Iron (Source bef. update: Metal Construction)

Cast iron has lower melting points (e.g. 1150°C to 1250°C for general cast iron) than that (approx. 1500°C) of steel, offers quite fluid characteristics in molten state, and undergoes moderate shrinkage during solidification and cooling. These physical features facilitate better castability in casting complex shape molds. Molded cast iron products, therefore, are used in various industrial fields. However, the notch toughness and ductility of cast iron are far lower than those of steel in general. These inferior properties limit the application. The mechanical properties of cast iron depend upon the type of microstructure as well as the form and distribution of the free graphite (uncombined carbon). The amount, size, and shape of the graphite particles affect the strength and ductility of cast iron. Hence, cast iron can be classified by the characteristics of the graphite as it appears in a polished section. There are four basic types of cast iron as shown in **Fig. 1.1**: gray iron, malleable iron, spheroidal graphite iron (also known as ductile or nodular iron), and white iron. The characteristics of these different types of cast iron are outlined in the following sections.

1.1 Gray cast iron

Gray cast iron contains uncombined carbon in the form of graphite flakes in the matrix which is commonly pearlite, ferrite or their mixture, as shown in **Photo 1.1**. Gray cast iron lacks ductility because of the flake form graphite. This type of cast iron is named from the gray appearance of its fractured surface.

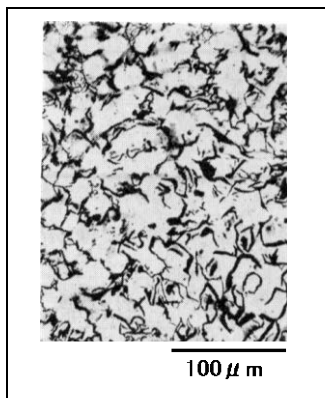

Photo 1.1 — Microstructure of gray cast iron
 • Etchant: Picric acid
 • Structure: Graphite flakes in the ferritic and pearlitic matrix

Table 1.1 shows the reference mechanical properties of gray cast iron products (FC200 and FC250), as per JIS G 5501:1995 (Gray Iron Castings), which are used for broad applications. Chemical requirements for gray cast iron may be agreed to between supplier and purchaser; however, gray cast iron generally contains 2.5-4.0% carbon, 1.4-2.5% silicon, 0.4-1.0% manganese, 0.05-1.0% phosphorus, and 0.06-0.15% sulfur. Typical applications are motor vehicle parts, pump housings, bedplates, and machine tools. Gray cast iron accounts for approximately 60% out of all the cast irons produced annually in Japan.

Table 1.1 — Reference mechanical properties of gray cast iron products (JIS G 5501:1995)

Grade	Thickness of castings (mm)	Tensile strength (N/mm ²)
FC200	10 ≤ T < 20	≥ 180
FC250	10 ≤ T < 20	≥ 225
FC300	10 ≤ T < 20	≥ 270
FC350	10 ≤ T < 20	≥ 310

1.2 Ductile cast iron

The mechanical properties of gray cast iron can be greatly improved by treating the molten iron that contains 3.2-4.5% carbon and 1.8-2.8% silicon with the magnesium or cerium addition before casting. This special technique can produce the exceptional cast iron with the graphite in spheroidal form instead of flakes, as shown in **Photo 1.2**. This type of cast iron is known as nodular cast iron, spheroidal graphite cast iron, or ductile cast iron. Ductile cast iron contains lower sulfur (e.g., 0.08% max) and phosphorus (e.g., 0.02% max) than gray cast iron in order to help the formation of spheroidal graphite.

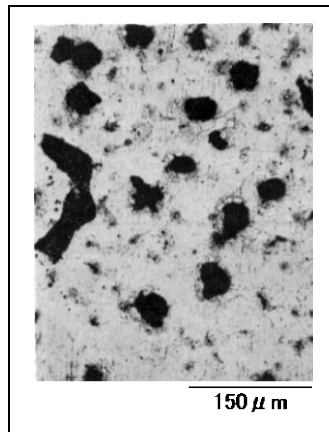

Photo 1.2 — Microstructure of ductile cast iron
 • Etchant: Picric acid
 • Structure: Spheroidal graphite in the ferritic and pearlitic matrix

The compact shape of graphite improves the mechanical properties of cast iron resulting in considerably high ductility and tensile strength as compared with gray cast iron. Ductile cast iron is much more resistant to mechanical wearing and has much less thermal expansion under cyclic heating. Therefore, it is used in crankshafts, engine liners, gears, mill rolls, ingot cases, and water and gas pipes. Ductile cast iron products (including pipes) account for approximately 30% out of all the cast irons produced annually in Japan. **Table 1.2** shows the specified mechanical properties of ductile cast iron products (FCD-400, FCD-500 and FCD-600), as per JIS G 5502:2007 (Spheroidal Graphite Iron Castings), which are commonly used in a wide range of applications. Chemical requirements for ductile cast iron shall be agreed to between supplier and purchaser as per the JIS standard. Traditionally the chemical composition may fall in the range: 2.5%C min, 2.7%Si max, 0.4%Mn max, 0.08%P max, 0.02%S max, and 0.09%Mg max.

Table 1.2 — Mechanical properties of ductile cast iron products (JIS G 5502:2007)

Grade	Thickness (mm)	Tensile strength (N/mm ²)	Elongation (%)
FCD 400-15A	30 < T ≤ 60	390 min	15 min
FCD 500-7A	30 < T ≤ 60	450 min	7 min
FCD 600-3A	30 < T ≤ 60	600 min	2 min

1.3 White cast iron

When cast iron contains smaller amounts of carbon (1.8-3.6%) and silicon (0.5-1.9%) than in the case of typical gray cast iron, the carbon cannot precipitate as graphite during solidification but remains in iron carbide (Fe_3C). Iron carbide, or cementite, is brittle but hard, and contributes to the higher compressive strength and wear resistance of the cast iron. This type of cast iron is called "white cast iron" since it has a white crystalline fracture appearance. Rolls and mill balls are typical applications for white cast iron.

1.4 Malleable cast iron

Malleable cast iron is produced from white cast iron by heat treatment, which is grouped into three types as shown in Fig. 1.1: blackheart malleable cast iron, whiteheart malleable cast iron, and pearlitic malleable cast iron. Typical applications are motor vehicle parts, pipe fittings, railroad vehicles, machine tools, and ship parts.

Blackheart malleable cast iron is produced from white cast iron by annealing at 900-950°C for the first stage, followed by the second stage annealing at the temperature around the A_1 transformation point. By this combined annealing process, the cementite contained in white cast iron can be decomposed to become graphite ($\text{Fe}_3\text{C} \rightarrow 3\text{Fe} + \text{C}$). The microstructure of blackheart malleable cast iron consists of a ferrite matrix and granular or aggregate graphite dispersed in the matrix as shown in **Photo 1.3**. The compact shape of graphite improves the ductility and strength of the iron casting. The fracture appears black in its internal areas.

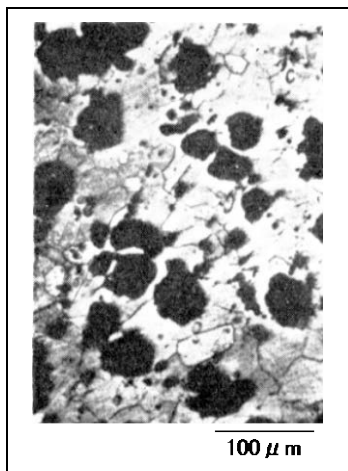

Photo 1.3 — Microstructure of blackheart malleable cast iron (Annealed at 920°C for 20 hours followed by 750°C x 30hr annealing)
• Etchant: Picric acid
• Structure: Graphite in black;
Ferrite in white

Whiteheart malleable cast irons are produced by annealing the white cast iron kept in contact with a decarburizing medium (ferric oxide) at 950-1000 °C for long hours to decarburize the cementite of the surface areas of the white cast iron. The decarburized surface areas consisting of ferrite feature improved ductility. Most of the cementite in the internal area is decomposed to become spheroidal graphite in the pearlitic matrix. The fracture appears white in the internal area. The application for whiteheart malleable cast iron is limited to thin products in order to use a uniform decarburized structure.

Pearlitic malleable cast irons are produced from white cast iron by annealing. The first-stage annealing thermal cycle is similar to that for the blackheart malleable cast iron; however, in the second-stage annealing, the cooling speed is increased to form a pearlitic structure by restricting the decomposition of cementite.

2. Weldability of cast iron in fusion welding

Arc welding is used particularly for repairing foundry defects contained in iron castings and machinery parts damaged or worn out by service. All types of cast iron except white cast iron are considered to be weldable but to a lesser degree than steel; however, the weldability varies depending on the type of cast iron. Some types of cast iron are readily weldable while the others require special welding procedures.

2.1 Common problems in weldability

All types of cast iron have common problems affecting their weldability; namely, (1) much carbon content, (2) lower ductility, (3) high content of phosphorus, sulfur and oxygen, (4) casting defects, and (5) impregnated oil. The following paragraphs discuss each of these problems.

(1) In a welding thermal cycle, as shown in **Fig. 2.1**, the cast iron base metal experiences different heat effects depending on the location in the entire heat-affected zone. That is, the area immediately adjacent to the weld metal is locally heated to an extremely high temperature and cooled rapidly; consequently, iron carbide tends to precipitate in the vicinity of the fusion line (referred to as the white-cast-iron zone). The remainder of the heat-affected zone is also heated and cooled rapidly, thereby forming high-carbon martensite (referred to as the martensite zone).

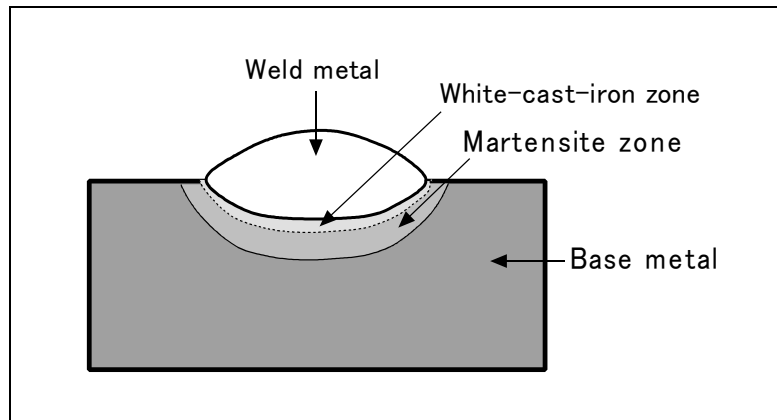

Fig. 2.1 — Microstructural representation of the heat-affected zone of a cast iron weldment cross-section

Both the white-cast-iron and martensite zones are characterized by the hard and brittle nature. In addition, the white-cast-iron zone is apt to contract much more than does the remainder of the base metal; this can be presumed with the reference data shown in **Fig 2.2**. Therefore, with the brittle structure and high contraction stresses, the heat-affected zone tends to generate cracks either spontaneously or under load during services. The degree of brittleness and propensity to cracking depend, to some extent, upon the type of cast iron and the welding procedure.

In addition, high carbon can be oxidized to become a CO gas, which tends to cause blowholes in the weld metal.

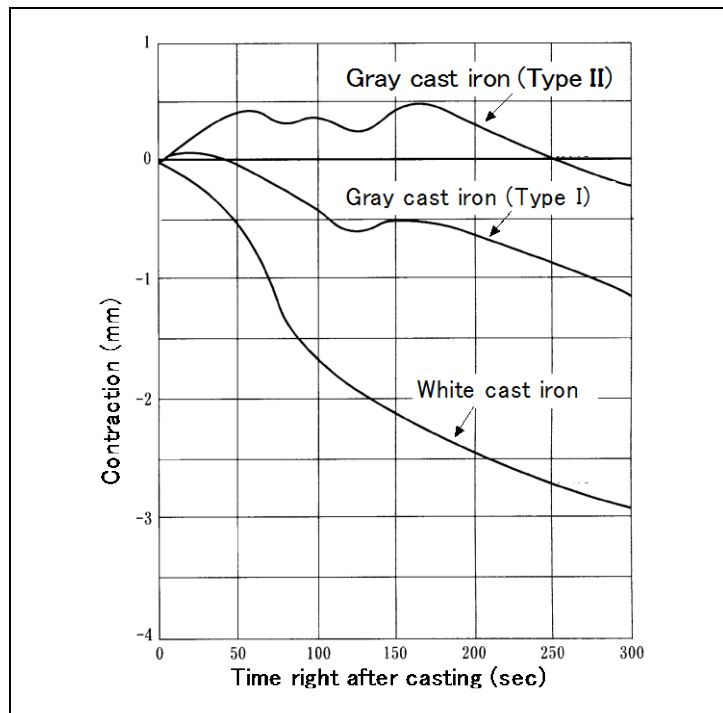

Fig. 2.2 — A comparison of thermal contraction on the cooling after casting between different types of cast iron

(2) Fusion welding involves localized heating and cooling and thus causes thermal stresses in the weld area being accompanied, as shown in **Fig. 2.3**, by expansion on heating, and by contraction on cooling. The base metal should be capable of local plastic deformation to accommodate the welding stresses, thereby preventing the occurrence of crack. Cast irons are generally liable to produce cracks because their low ductility may not be able to withstand the contraction stresses arisen by the cooling weld during fusion welding.

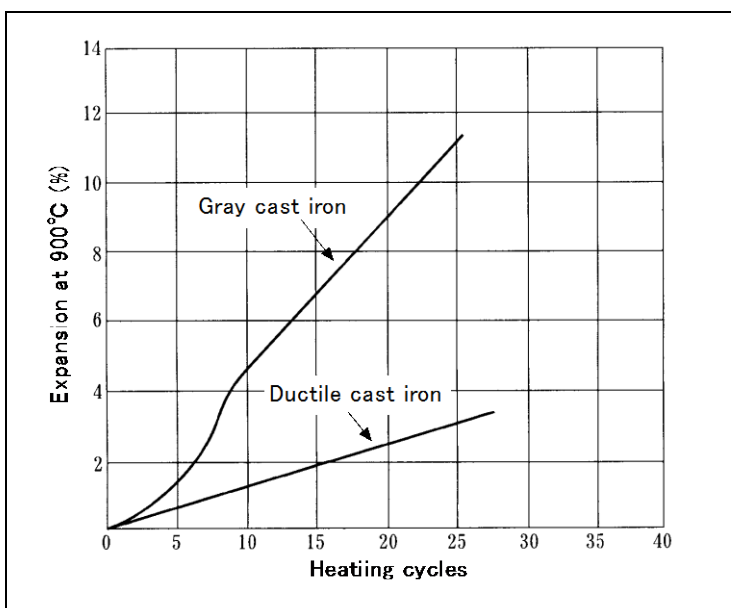

Fig. 2.3 — A comparison between different types of cast iron on the thermal expansion on heating as a function of the number of heating cycles

(3) High phosphorous content in cast iron tends to form hard metallic compounds with ferrous and carbon, which make the iron casting brittle. High oxygen and sulfur are apt to accelerate the precipitation of carbides, thereby causing a hard and brittle white-cast-iron microstructure. The phosphorous, sulfur and oxygen dissolved in weld metal can cause cracking of the weld metal.

(4) Cast iron often contains such casting defects as sand inclusions and shrinkage cavities, which prevent complete fusion or better wetting of molten weld metal onto the base metal.

(5) Cast iron parts after service are often contaminated with impregnated oil which causes welding defects such as blowholes and cracks.

2.2 Effects of graphite form on weldability

In order to minimize the formation of massive carbides and high-carbon martensite, the graphite should present in a spheroidal shape with a low surface-to-volume ratio. As the surface area of the graphite in contact with the austenitic matrix decreases, the amount of carbon in the microstructure can decrease at room temperature. Graphite flakes contained in gray cast iron display the greatest tendency to dissolve in austenite because of their relatively large surface area. Thus, gray cast iron is inherently brittle and often cannot withstand the contraction stresses arisen by fusion welding. Since graphite flakes cause lack of ductility, the cast iron that contains long graphite flakes is more brittle and less weldable than those with short flakes or spheroids. Ductile cast iron contains graphite in spheroidal form and thus features better ductility; therefore, this type of cast iron has superior weldability to any other types.

3. Welding processes

3.1 Shielded metal arc welding

Shielded metal arc welding (SMAW) accounts for over 80 percent of the welding performed on iron castings; over 50 percent of which is used to salvage new castings in the foundry; about 40 percent of which is for repair of parts that have been worn or failed in service or that require modification. The remaining 10 percent is used in fabrication of assemblies to join two or more cast iron parts or to join a cast iron part to another metal.

In the welding of iron castings, the weld metal must tolerate an increase of carbon content caused by the dilution with the base metal. This is why non-ferrous type, nickel alloy type and low-carbon steel type covered electrodes are used. In particular, AWS ENi-CI, ENiFe-CI, and ESt are typical grades being used extensively in the repair and reclamation of iron castings.

3.2 Gas shielded metal arc welding

Gas shielded metal arc welding (GSMW) is used in the repair, reclamation and fabrication of iron castings. The low heat input modes such as short-circuiting transfer and pulsed-current arcs can restricts the heat affects on the base metal, thereby minimizing the formation of brittle iron carbides in the heat-affected zone with marginally better crack resistance. In addition, minimized dilution of the weld metal by the base metal will reduce the tendency of weld cracking. The spray transfer mode is used only for the production of simple, low-stress welds in low-strength high-ductility grades of cast iron.

Solid wires and flux-cored wires are available. 98%Ar-2%O₂, 75%Ar-25%CO₂, or 100%CO₂ is

used for the shielding gas. AWS ERNi-CI and ERNiFeMn-CI are common grades of solid wires. Flux-cored wires for iron castings include nickel-iron type and nickel-iron-manganese type. ENiFeT3-CI is a flux-cored wire that uses no shielding gas, the typical application of which is overlaying crane hoist drums (gray cast iron), overlaying ingot molds (gray cast iron), and welding end caps of ductile cast iron to cylinders of low-carbon steel pipe.

3.3 Gas tungsten arc welding

Gas tungsten arc welding (GTAW) is suited for repairing gas cavities (porosity) formed during casting. Typical filler metals are of the ductile cast iron, nickel, nickel-iron, and nickel-iron-manganese types.

3.4 Submerged arc welding

The ERNiFeMn-CI solid wire or ENiFeT3-CI flux-cored wire with a suitable flux has enabled the submerged arc welding of ductile cast irons and other cast irons. However, the submerged arc welding of cast irons uses smaller-size wires, lower welding currents, and lower travel speeds than in the welding of steels. The rebuilding of cable drum rolls and other parts having cylindrical surfaces are typical applications of this welding process.

4. Welding consumables

4.1 Types and classifications

The proper type of welding consumable (filler metal) for welding iron castings depends on the welding process, type of cast iron, necessity of postweld machining, possibility of preheating and postweld heat treatment, requirements for the mechanical properties of welds, and the need of color-matching between base metal and weld metal. **Table 4.1** lists typical filler metals available for welding cast irons in relation to applicable welding processes, specifications, and classifications. **Table 4.2** shows the chemical requirements of the AWS standard for the covered electrodes used extensively in welding cast irons and the typical mechanical properties of the undiluted weld metals.

Table 4.1 — Typical SMAW and GMAW filler metals for welding cast irons ⁽¹⁾

Welding process	Form of filler metal	Type of Undiluted weld metal	AWS standard		JIS standard	
			Spec. ⁽²⁾	Classification	Spec. ⁽³⁾	Classification
SMAW	Covered electrode	95Ni alloy	A5.15	ENi-CI	Z3252	ECNi-CI
		53Ni-45Fe alloy	A5.15	ENiFe-CI	Z3252	ECNiFe-CI
		40Ni-44Fe-12Mn alloy	A5.15	ENiFeMn-CI	Z3252	ECNiFeMn-CI
		65Ni-30Cu-4Fe alloy	A5.15	ENiCu-B	Z3252	ECNiCu-B
		Low-carbon steel	A5.15	Est	Z3252	ECSt
		Cast iron	—	—	Z3252	ECFeC-3
GMAW	Solid wire	93Ni alloy	A5.15	ERNi-CI	Z3252	SCNi-CI
		40Ni-45Fe-12Mn alloy	A5.15	ERNiFeMn-CI	Z3252	SCNiFeMn-CI
	Flux-cored wire	52Ni-40Fe-4Mn alloy	A5.15	ENiFeT3-CI	Z3252	TCNiFeT3-CI
		55Ni-42Fe alloy	A5.15	ENiFe-CI	Z3252	TCNiFe-1

Note: (1) The AWS and JIS classes are not necessarily equivalent to each other in a precise sense.

(2) AWS A5.15:90(R2006) (Welding Electrodes and Rods for Cast Iron)

(3) JIS Z 3252:2012 (Covered Electrodes, Solid Wires, Rods and Flux Cored Wires for Cast Iron)

Table 4.2 — Chemical requirements for and typical mechanical properties of covered electrodes for cast irons

AWS Class.	Chemical requirements (%)									Typical mechanical properties ⁽¹⁾			
	C	Si	Mn	S	Fe	Ni	Cu	Al	Others	0.2% P.S. (MPa)	T.S. (MPa)	El. (%)	HB
ENi-CI	2.0 max	4.0 max	2.5 max	0.03 max	8.0 max	85 min	2.5 max	1.0 max	1.0 max	262-414	276-448	3-6	135-218
ENiFe-CI	2.0 max	4.0 max	2.5 max	0.03 max	Rem	45-60	2.5 max	1.0 max	1.0 max	296-434	400-579	6-18	165-218
Est	0.15 max	0.15 max	0.60 max	0.04 max	Rem	—	—	—	P:0.04 max	—	(490)	(33)	250-400

Note (1): The typical mechanical properties of the undiluted weld metals listed in AWS A5.15:90 (2007) appendix Table A1, except for those given in the parentheses which are from Kobe Steel's CI-A3.

4.2 Typical covered electrodes for SMAW

(1) Nickel type (ENi-CI, ENiFe-CI)

Nickel type electrodes can overcome the problem of carbon pick-up from the cast iron base metal because carbon can be dissociated in the form of fine, dispersed graphite in the weld metal, thereby providing readily machinable and ductile characteristics. In addition, nickel type weld metals suppress the carbon diffusion at the interface between the base metal and the weld metal, thereby decreasing the formation of the white-cast-iron microstructure in the heat-affected zone. **Fig. 4.1** depicts that an ENi-CI weld metal exhibits relatively low hardness in the heat-affected zone with marginally better crack resistance.

Nickel type electrodes are used for welding gray, malleable, and ductile cast irons. However, nickel type weld metals are susceptible to solidification cracking due to pick-up of sulfur and phosphorus from the base metal. Therefore, welding currents should be lower as far as sufficient fusion can be ensured. The machinability of the welds is very good but the color matching with the base metal is poor.

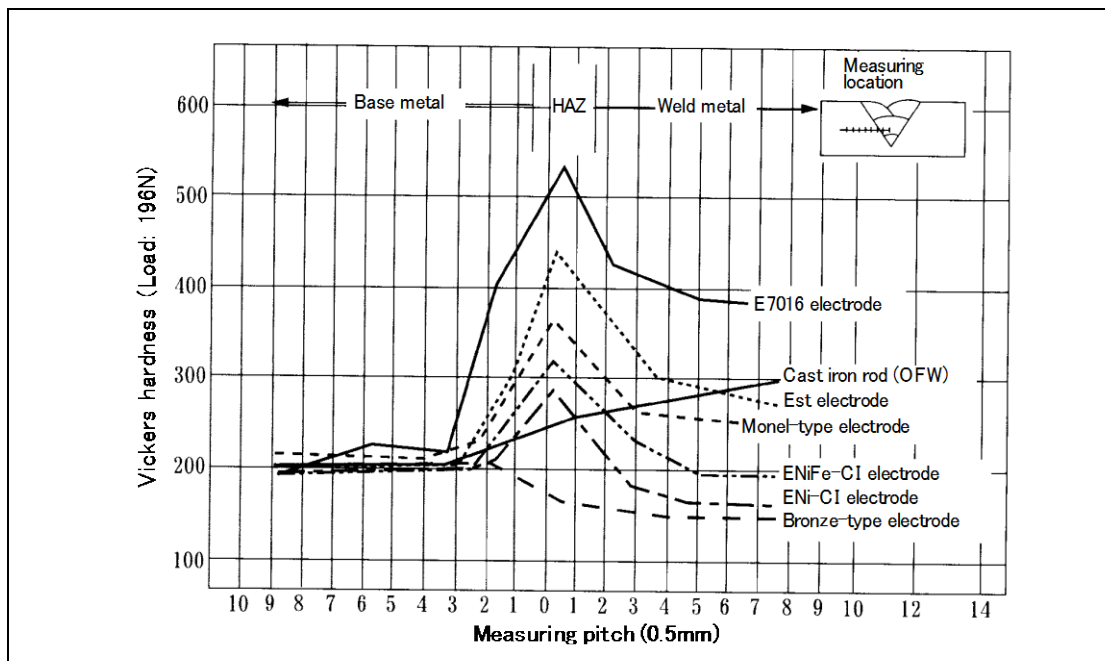

Fig. 4.1 — A comparison between various filler metals for cast irons on Vickers hardness in groove welds

(2) Nickel-iron type (ENiFe-CI, ECNiFe-CI)

Nickel-iron type electrodes are used for welding gray, malleable and ductile cast irons. These electrodes are more economical than the nickel type electrodes due to lower content of nickel, and the weld metal is less susceptible to the solidification cracking caused by phosphorus and sulfur. The weld metal has higher tensile strengths, hardness, and thus lower machinability as compared with nickel type electrodes. The color matching with the base metal is as poor as with nickel type weld metals. This type of weld metal offers lower thermal contraction, which is preferable for preventing the occurrence of crack.

The nominal nickel content of the undiluted weld metal of this type of electrode is 53% but that of the diluted weld metal can fall, depending on the penetration, in the range 35-45%, which offers relatively lower linear expansion coefficient as shown in **Fig. 4.2**. This is why the contraction stresses can be lower, which in turn offers better crack resistance.

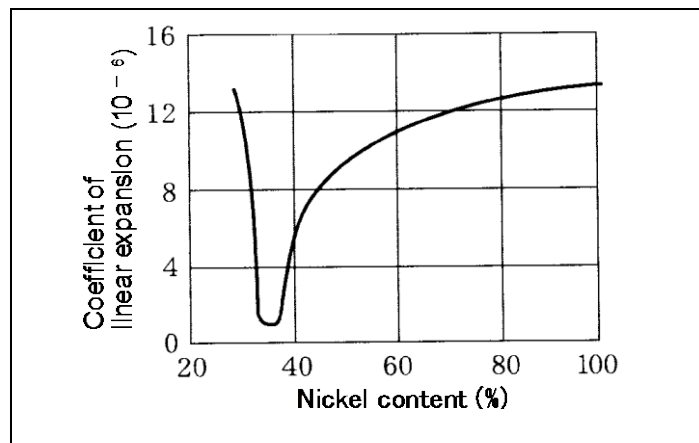

Fig. 4.2 — Coefficient of linear expansion of Fe-Ni alloys

(3) Low-carbon steel type (Est, ECSt)

This type of electrode offers better wettability with the base metal when compared to nickel-type and nickel-iron-type electrodes. The coating flux of the electrode contains a special agent that promotes carbon to become graphite, which provides the fusion zone with lower hardness than with ordinary mild steel covered electrodes as shown in Fig. 4.1. However, it is virtually impossible to prevent the formation of a hard zone or layer in the weld metal because of dilution from the base metal. The diffusion rate of carbon from the base metal to the weld metal is relatively high; consequently, the fusion zone tends to form the white-cast-iron microstructure. In addition, the shrinkage of steel is greater than that of cast iron, thereby developing higher stresses on cooling the weld. Because of these reasons, in order to prevent weld cracking, this type of electrode uses higher preheating temperatures than with the nickel-type and nickel-iron-type electrodes, and the application is limited to the repair of small pits and cracks where color matching is desirable and postweld machining is not of major concern.

The characteristics of this type of electrode vary markedly depending on the formulas designed by the manufacturers; therefore, the filler metal supplier or manufacturer should be consulted for product recommendation.

5. Welding procedures

As mentioned in Section 2, all cast irons have common problems of inferior weldability as compared with steels, though the extent of this problem depends upon the type of cast iron. Therefore, in actual welding, appropriate procedures should be taken in order to cope with these problems. The following are some important factors to get successful results in the repair welding of cast irons by shielded metal arc welding.

5.1 Groove preparation

In the repair welding of cast irons, foundry defects such as shrinkage cavities, sand inclusions, porosity and cracks should be removed by mechanical means, and the removed area should be prepared with a welding groove so as to ensure better fusion and easier welding operation. The mechanical means includes form cutters, pneumatic chisels, and grinders. For preparing the groove, arc air gouging which causes localized rapid heating and cooling should be avoided to prevent cracking. The groove should be prepared with a larger groove angle and a larger radius at the bottom of the groove than for steels to ensure complete fusion and easier welding operation. **Fig. 5.1** shows examples for welding grooves suitable for repairing iron castings.

In a case where impregnated oil is present in the groove, swab the groove surface with paraffin and heat it at approximately 400°C to burn off the oil adequately to ensure better fusion and prevent welding defects.

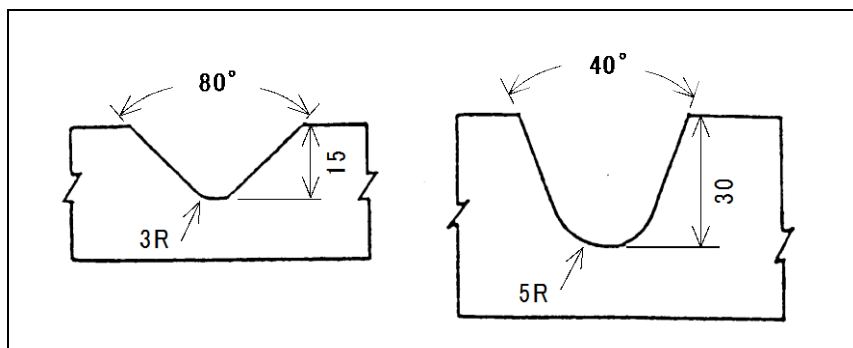

Fig. 5.1 — Examples of groove sizes for repairing iron castings

5.2 Preheat

As discussed in Section 2, the formation of a hard, brittle heat-affected zone may lead to cracking on cooling right after welding or in service. The hardness of the heat-affected zone can be decreased by preheating the base metal because preheating can reduce the cooling rate of the heat-affected zone. Slower cooling rates can suppress the formation of iron carbides and martensite structures in the heat-affected zone, which in turn reduce the propensity for weld cracking, by decreasing the hardness of the weld as shown in **Figs.5.2** and **5.3** and **Photo 5.1**.

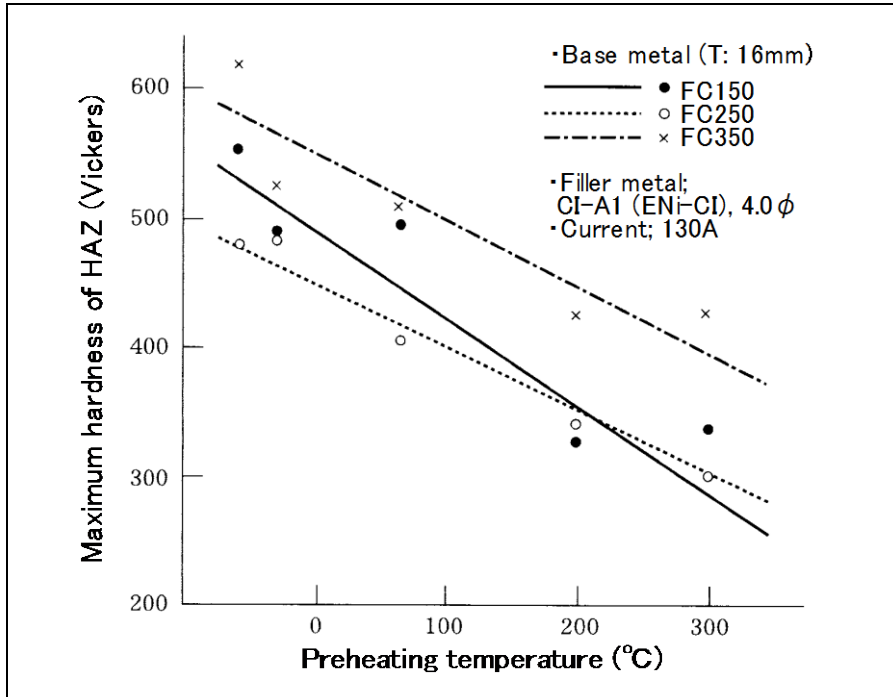

Fig. 5.2 — Effect of preheating temperature on the maximum hardness of the heat-affected zone of the weld with a gray cast iron base metal and nickel-type filler metal

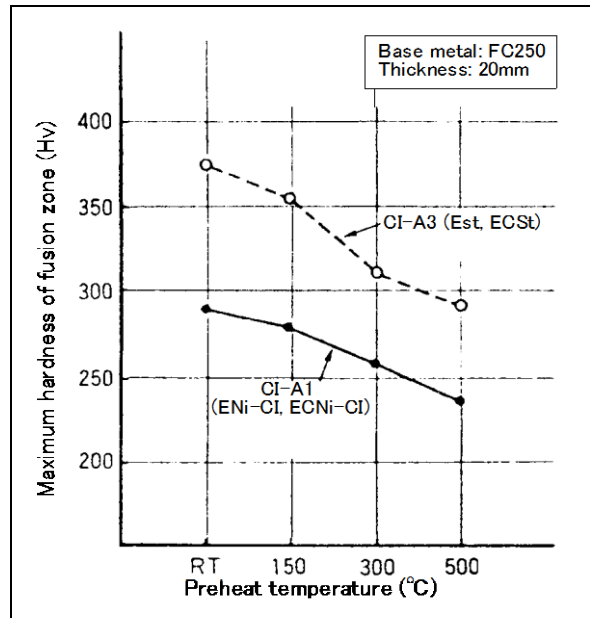

Fig. 5.3 — Effect of preheating temperature on the maximum hardness of the fusion zone of the cast iron weld in comparison between nickel-type and steel-type filler metals

It is apparent, in Fig. 5.3, that the maximum hardness of the fusion zone is lower with the nickel-type electrode than with the steel-type electrode. This is because the nickel-type weld metal suppresses carbon to diffuse from the base metal to the weld metal, thereby minimizing the propensity to form the white-cast-iron microstructure. As shown in Photo 5.1, in order to suppress the white-cast-iron microstructure in the fusion zone, the nickel-type electrode needs 150°C for preheat while the steel-type electrode needs 300°C.

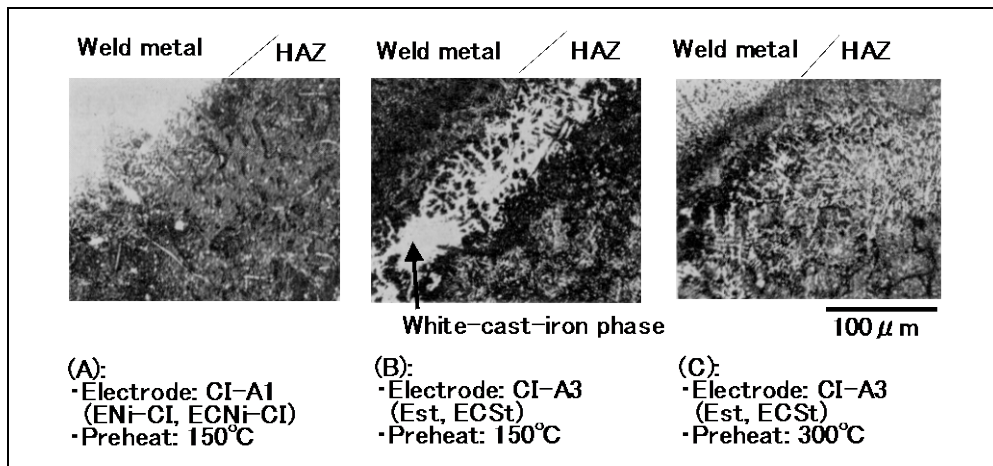

Photo 5.1 — Effect of preheat on the microstructure of the fusion zone of the welds with nickel-type and steel-type filler metals
 (Base metal: FC250, 20-mm thick; Etchant: Picric acid)

The proper preheating temperature for preventing weld cracking depends upon the type of cast iron, the mass of casting, and the type of filler metal. The proper preheat temperature ranges recommended by Kobe Steel, for welding gray cast irons and ductile cast irons, are given in **Table 5.1**. This recommendation is for the low-temperature-preheat SMAW procedure.

Table 5.1 — Recommended preheat temperatures for the low-temperature-preheat SMAW procedure

Type of filler metal		Preheat temperature (°C)
AWS	JIS	
ENi-CI	ECN-CI	100-300
ENiFe-CI	ECNiFe-CI	150-350
Est	ECSt	350-400 ⁽¹⁾

Note (1): For low-carbon type electrodes of CI-A3 from Kobe Steel

The low-temperature-preheat procedure (also known as “cold welding procedure”) is commonly used for repairing a large casting or a cast part installed in a machine where it is very hard or unpractical to heat the work in the high temperature range (500-600°C) which is suitable for the high-temperature preheat procedure (also known as “hot welding procedure”). In contrast, the hot welding procedure solidifies the molten weld metal under the stable condition being close to the equilibrium, using very-slow cooling rates from the molten state. This procedure prevents completely the formation of cementite, promoting the graphitization of carbon, with filler metals of cast iron or steel such as JIS ECFcC-3 and ECSt.

A crack caused by irregular expansion may occur during preheating of complex castings or when the preheating is confined to a small area in a large casting. Local preheating, therefore, should be gradual. Uniform preheating of either a large section in a casting or the entire casting is preferable.

The preheating temperature should be maintained until the welding is completed while controlling the interpass temperature. The interpass temperature should be controlled equal to the preheating temperature or higher, but not excessively high. Continuous welding can cause excessive heats in the weld. If the temperature of the weld increases over 600°C, the cast iron base metal can expand rapidly as shown in **Fig. 5.4**. This is because cementite in the cast iron rapidly deforms to become graphite ($\text{Fe}_3\text{C} \rightarrow \text{Fe} + \text{C}$), accompanying a rapid expansion. The rapid expansion may cause cracking; therefore, the interpass temperature should be controlled so as to ensure the preheating temperature and suppress the temperature of the weld below 600°C.

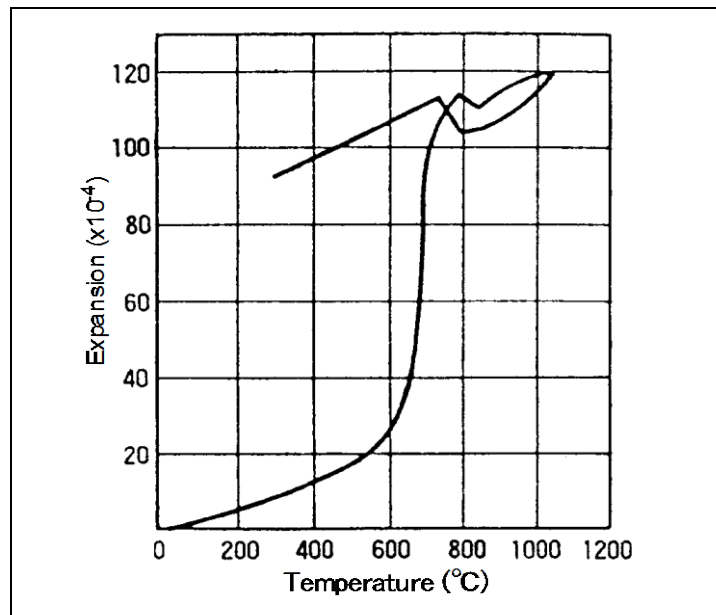

Fig. 5.4 — Expansion of cast iron (C: 3.49%, Si: 3.70%) caused by the dissociation of cementite as a function of temperature.

5.3 Postweld heat treatments (PWHT)

After welding, heat treatment of a cast iron weldment may be necessary for the following purposes:

- (1) Improve the ductility of the heat-affected zone (HAZ).
- (2) Improve the machinability of the weld metal and HAZ.
- (3) Decompose the cementite formed during welding.
- (4) Transform martensite to a less brittle microstructure (troostite).
- (5) Relieve residual stresses.

Fig. 5.5 shows the effect of PWHT temperature on the hardness of the heat-affected zone of the gray cast iron base metal welded with an ENi-CI electrode. As shown in the figure, with a higher PWHT temperature, the hardness of the heat-affected zone decreases. **Table 5.2** gives the PWHT recommendations for cast iron welds in accordance with WES 7104-2012 (Recommended Practice for Arc Welding of Cast Iron) issued by The Japan Welding Engineering Society.

Fig. 5.5 — Effect of postweld heat treatment temperature on hardness of the heat-affected zone of a gray cast iron welded with an ENi-CI electrode

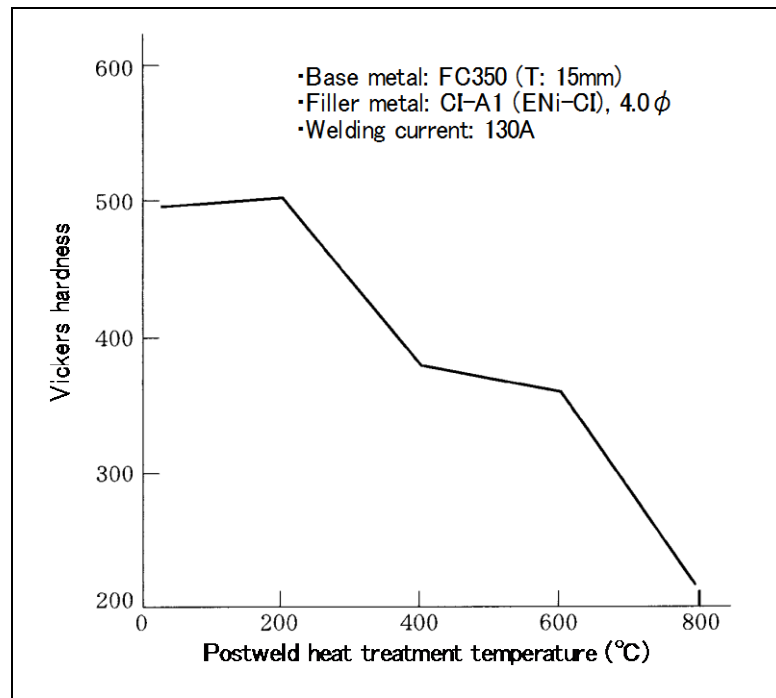

Table 5.2 — Recommendation for annealing of cast irons (WES 7104-2012)

Purpose of PWHT	Temperature and soaking time	Cooling rate
Stress relief annealing	550-600°C × 1.5hr/25mm of thickness	Furnace cooling at about 50°C/hr to 300°C followed by air cooling
Full annealing	800-900°C × 1hr/25mm of thickness	

Note: Stress relief annealing is mainly to relieve stresses while full annealing is mainly to graphitize carbon in welds as well as stress relief.

Normally, stress relief is performed by increasing the temperature of the entire casting, immediately after welding. However, practically, the finished weldment may be required to cool to the room temperature before PWHT. When heat treatment cannot be started right after welding, the casting should be cooled slowly from the welding temperature to the room temperature by covering it with insulating materials such as blanket, diatomite, ash, and hot sand. This slow cooling is to prevent thermal stresses, thereby preventing the occurrence of weld cracking.

5.4 Deposition methods

This section focuses on the cold welding procedure that is extensively used in the repair welding of iron castings, which is very different from the hot welding procedure. The following techniques should be used in order to minimize the dilution by the base metal, the heat-affected zone, and thermal stresses, thereby preventing weld cracking.

- (1) Use the short-bead deposition in which a weld bead length is 30-50mm.
- (2) Use lower welding currents with smaller-diameter electrodes.
- (3) Lay straight weld beads as possible; however, the weaving technique may be used, provided the weaving width is limited to approximately 1.5 times the diameter of the electrode used.
- (4) Use the buttering technique and multi-pass welding for a deep groove (refer to **Fig. 5.6**) in order to decrease the hardness of the heat-affected zone (refer to **Fig. 5.7**) and thus to prevent cracking. The buttering improves the heat-affected zone microstructure by the tempering effect provided by the heat of subsequent welding. For buttering the groove, smaller-diameter electrodes are preferable to minimize heat input into the base metal.

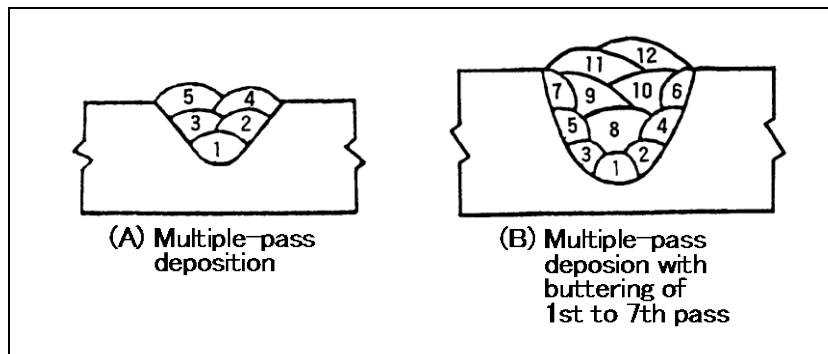
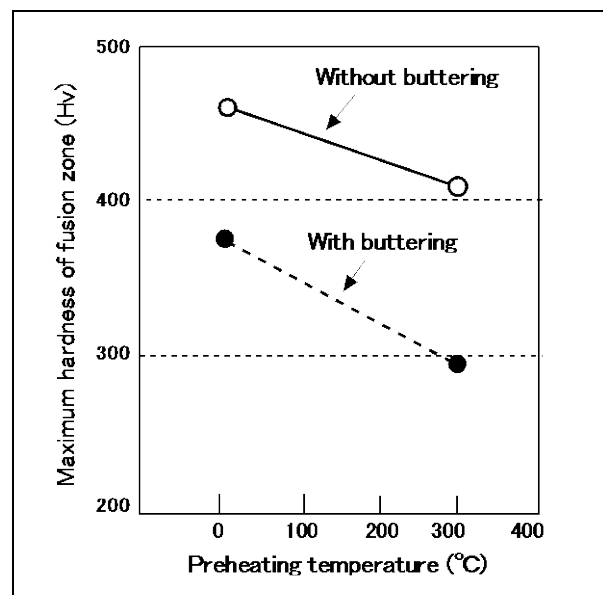

Fig. 5.6 — Multiple-pass deposition with or without buttering

Fig. 5.7 — Effect of the buttering technique on the maximum hardness of the fusion zone in multiple-pass welds of cast iron with a deep groove

- Base metal: Ductile cast iron, 40mmT
- Filler metal: CI-A2 (ENiFe-CI, ECNiFe-CI)



(5) The back-step sequence can reduce transverse and longitudinal weld shrinkage stresses by modifying the weld heat distribution as shown in **Fig. 5.8**. The back-step technique uses short weld beads made opposite to the direction of weld progression. All weld beads should overlap and should be deposited in the same direction. Like the back-step sequence, the stepping-stone and symmetrical sequences can also disperse the arc heats.

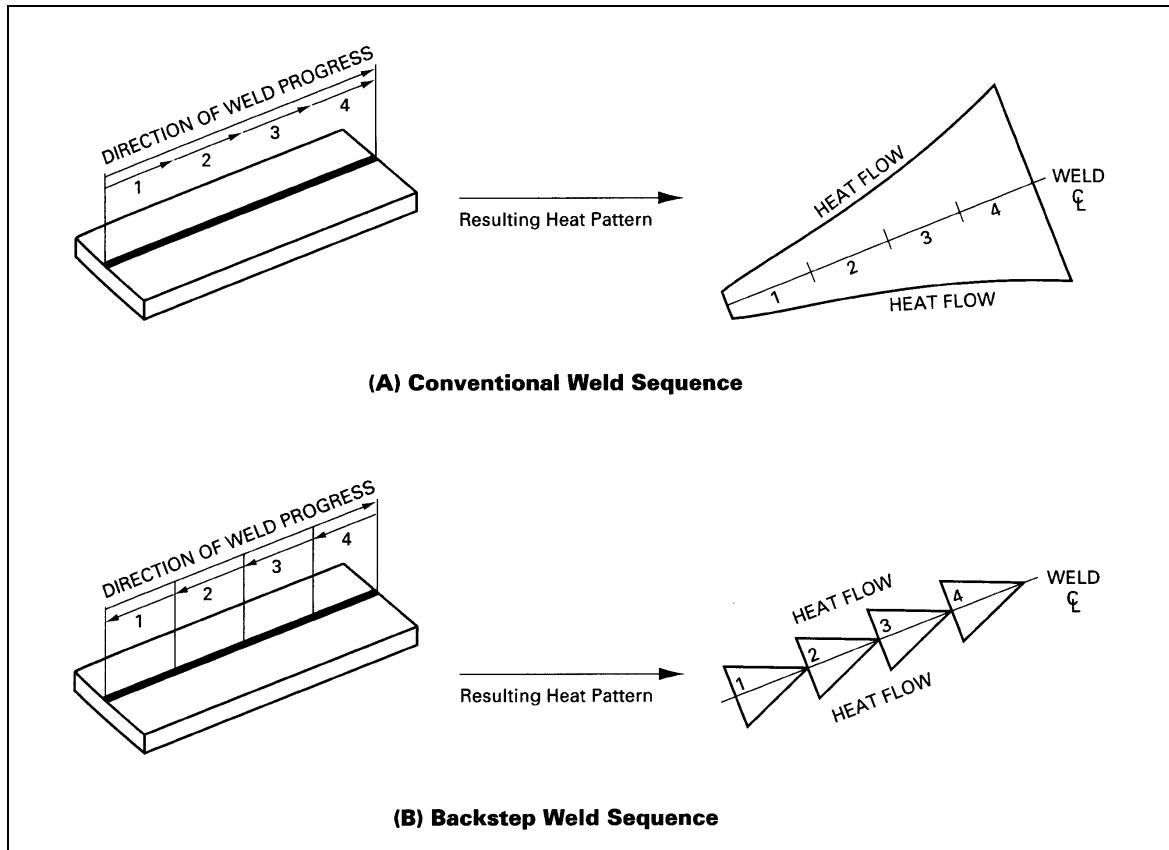

Fig. 5.8 — A comparison between conventional weld sequence and back-step weld sequence on the arc heat distribution (Source: AWS Welding Handbook)

5.5 Peening

Peening can be defined as the mechanical working of weld metals using impact blows. Peening is accomplished by repeated hammer blows onto the surface of the weld metal. The blows may be applied manually, as with a hammer, or with pneumatic tools. Peening tends to stretch the surface of the cold weld metal, thus reducing contraction stresses.

In welding iron castings, peen each short bead while it is still hot immediately after completion of each weld pass and removal of slag. Peening the weld bead helps to reduce residual stresses as shown in **Fig. 5.9** by applying plastic deformation, thereby decreasing the propensity for cracking. Peening should be done with repeated, moderate blows using a peening hammer with round-nose, or square-nose where the bead has a slippery surface. The force of peening should be sufficient to deform the weld metal to an extent that the weld ripples are completely removed but without rupturing the weld. **Fig. 5.10** gives examples of contour of the tips of peening hammers.

Fig. 5.9 — Effect of peening on stress relief of cast iron welds (WES 7104-2012)
 • Base metal: FC250, 30Tx150x200
 • Preheat: 100°C
 • Filler metal: ECNiFe-CI
 (1 kgf/mm² = 9.8 MPa)

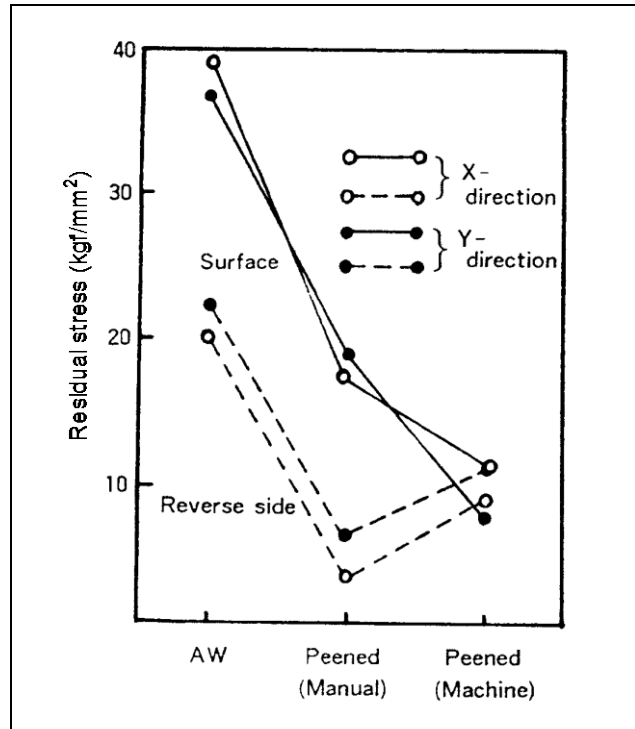

Contour of hammer tip	size (mm)
	5 φ × 10R
	7 φ × 10R
	10 φ × 7R
	4 × 8 × 7R
	6 × 14 × 7R
	8 × 16 × 7R

Fig. 5.10 — Examples of contour of the tip of a peening hammer (WES 7104-2012)

5.6 Studding and cramping

In the welding repair of iron castings, it is sometimes hard to burn off sufficiently the impregnated oil in the area to be welded. In some cases, the surfaces of iron castings are contaminated with severe oxides. Such a contaminated iron casting has poor weldability, and thus welding may result in cracking and disbonding. In this case, studding or cramping the weld is effective to reinforce the weldment.

5.6.1 Studding

As shown in Fig. 5.11, carbon steel studs are commonly studded by screws in the groove of an iron casting. Welding is started at each stud and is progressed to fill the surrounding areas. Finally, the studs are covered with deposited metal. The studs prevent the disbonding at the fusion zone and the cracking in the weld as well as strengthening the weld joint. Ingot case is a typical application for this technique.

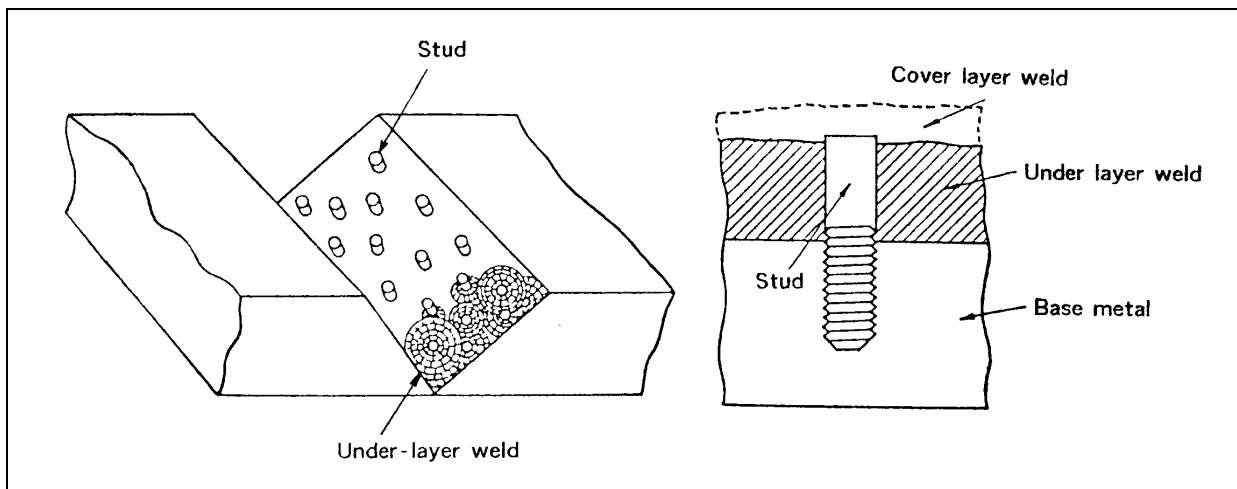

Fig. 5.11 — Welding repair with a large mass weld by studding
(Source: Welding Technology Series 12)

5.6.2 Clamping

In clamping, steel plates or steel bars are fixed to clamp a weld joint as shown in Fig. 5.12, by which the disbonding at the fusion zone and the cracking in the weld can be prevented, and the weld joint can be strengthened. This procedure is often applied to repair cracks occurred in a large scale casting,

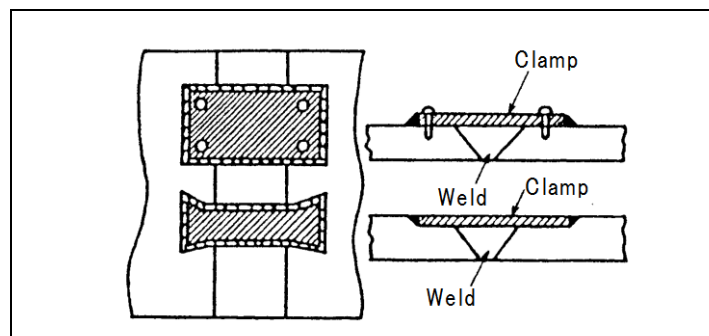

Fig. 5.12 — Welding repair by clamping (WES 7104-2012)

5.7 Patching

The patching technique is often used to repair a casting that contains multidirectional cracks or its wall is partly missed. In this method, the defective area is cut off, and a steel patch plate is welded in place as shown in **Fig. 5.13**. The welding repair of an engine cylinder block damaged by a broken connecting rod is an example of application for this technique.

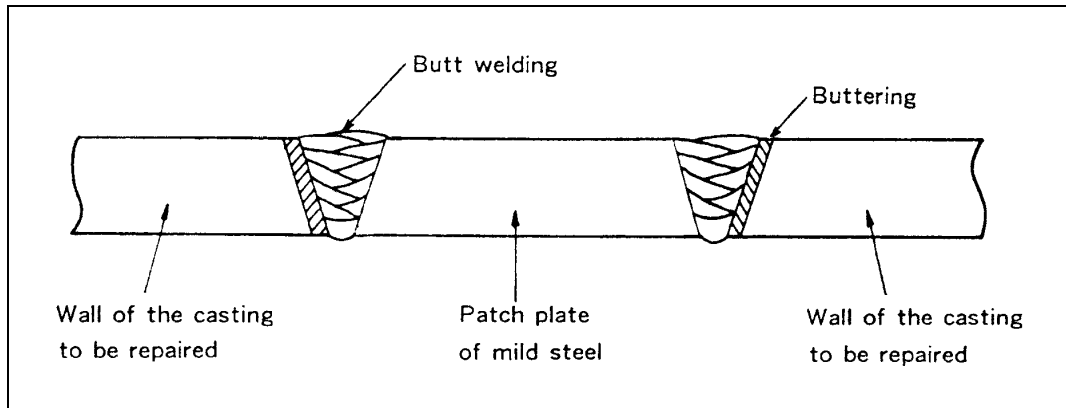

Fig. 5.13 — A sectional view of weldment repaired by patching

Arc Welding for Hardfacing

Contents

1. Preface 5-2
2. Types of wear 5-2
3. Weldability of base metals 5-5
4. Welding consumables for hardfacing 5-7
5. Characteristics of hardfacing filler metals 5-10
 - 5.1 Pearlitic type 5-10
 - 5.2 Martensitic type 5-11
 - 5.3 13%Cr stainless steel type 5-11
 - 5.4 High-Mn austenitic type 5-11
 - 5.5 High-Cr iron type 5-11
 - 5.6 Tungsten carbide type 5-12
 - 5.7 Co-Cr-W type 5-12
6. Wear resistance of hardfacing weld metals 5-12
 - 6.1 Resistance to scratching abrasion 5-13
 - 6.2 Resistance to abrasive-impact wear 5-14
 - 6.3 Wear resistance of ripper tips 5-15
7. Essential factors for hardfacing procedure 5-16
 - 7.1 Preheat and interpass temperature 5-16
 - 7.2 Dilution by base metal 5-18
 - 7.3 Quenching and tempering 5-18
 - 7.4 Work-hardenability 5-19
 - 7.5 Underlaying 5-20
 - 7.6 Pattered reinforcement 5-21
8. Highly efficient hardfacing processes 5-22

1. Preface

Hardfacing is the application of a hard, wear-resistant material to the surface of a workpiece by welding or spraying, or allied welding processes, to reduce wear or loss of material by wearing. This chapter deals with the hardfacing by arc welding only. Hardfacing is used either, in maintenance, to reclaim machinery parts by repairing the surfaces worn or lost in service, or, in production, to provide the surfaces of machinery parts of good weldability steel with hard, wear-resistant weld metals.

In order to accomplish successful hardfacing, the following factors should be thoroughly examined in advance.

- (1) What type of wear the hard-faced area will be subject to.
- (2) What type of weld metal will be more resistible to the predicted type of wear.
- (3) What welding process will be more suitable for better quality and welding efficiency.
- (4) What preventive measure should be taken to minimize cracking and distortion.

2. Types of wear

Wear can be defined as “the phenomenon in which the surface of a metal is detached by a mechanical action alone or being accompanied by a thermal or chemical attack (thermal stresses or oxidation).” The mechanical action can be generated by the relative motion between the surface of a metal and some contacting substances thereon. This phenomenon is so complicated that a sufficient theoretical explanation has not been available yet. Wear may be associated with many factors, and it is very difficult to clearly identify the actual cause, and to know which factor is most responsible. Even if the factors can be identified, it is difficult to quantify how much each factor influences the wear. However, it is instructive to know what types of wear can be involved in general applications, for better analysis of the wear involved in a specific case. **Table 2.1** shows a typical classification of the types of wear, by the nature of the contacting substances and the wear mechanism. **Figs 2 .1 to 2 .6** depict the principles of typical wears.

In services of a machine component, for instance, different types of wear may be involved at the same time; the wear analysis, therefore, is not easy in most cases. Suppose the wear between the track link and roller of an excavator in operation (**Photo 2.1**) for example. As the surfaces of the track-link and the roller contact each other during operation, adhesive wear can take place on each surface. However, they are not always contacting on the metal surfaces, because some soil may come in between. In this case, the surfaces are subjected to grinding wear by the soil with considerable stresses. As the track link and roller sustain repetitive impact stresses, depending on the operational condition, fatigue can take place on the interface. That is, adhesive wear, grinding wear and impact fatigue can take place on the interface between the track link and roller at the same time.

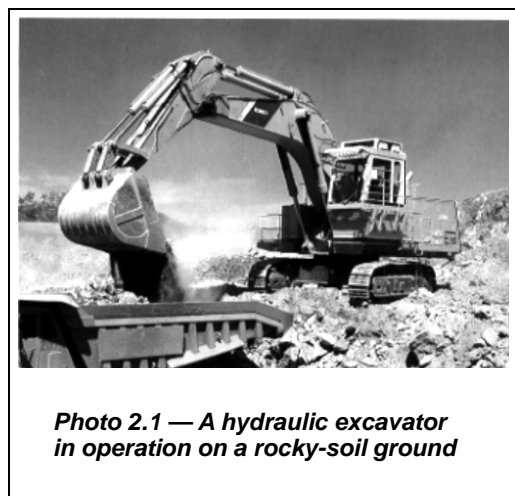

Therefore, when selecting a suitable welding procedure for hardfacing, experiences in actual services are very important as well as laboratory test results. This is to know the suitability of the welding procedure to an intended application, since it is difficult to know theoretically the suitability of a welding procedure for an application where different types of wear progress at the same time.

Table 2.1 — Classification of wearing modes

Classification by nature of contacting substance	Classification by applied stress	Typical machinery parts
① Wear by metal-to-metal contact	(a) Adhesive wear ⁽¹⁾ (Adhesion and shearing stresses)	Pistons and cylinders, Gears, Shafts and bearings, Cams, Sprockets
	(b) Rolling wear (Fatigue stresses)	Ball bearing's balls and shafts, Rails and wheels
	(c) Impact wear ⁽²⁾ (Impact fatigue stresses)	Forging hammer heads and anvils
	(d) Thermal impact wear (Thermal fatigue stresses)	Hot rolls, Continuous casting rolls
② Wear by sand, soil and stones	(a) Scratching abrasion ⁽³⁾ (Low shearing stresses)	Chutes, Plows, Conveyor screws, Wheel loader buckets
	(b) Grinding abrasion ⁽³⁾ (Middle shearing stresses)	Bulldozer blades, Bulldozer shoes, Dredger cutter knives, Earth moving machinery, Mill rolls
	(c) Gouging abrasion ⁽³⁾ (High shearing stresses including impact stresses)	Bulldozer ripper tips, Jaw crushers, Gyrotory crushers, Mill hammers
③ Wear by high-speed fluids	(a) Erosion ⁽⁴⁾ (Shearing stresses arisen by a collision of a fluid with sandy soil)	Dragger sand pump casings and impellers, Mud pumps, Pipelines, Agitators
	(b) Cavitation erosion ⁽⁴⁾ (Impact stresses caused by the explosion of bubbles generated in a fluid)	Hydraulic power turbines, Ship's propellers, Regulating valves, Pump impellers

Note:

(1) Adhesive wear

When microscopically uneven surfaces of metals are contacted by the applied force sufficient to make them come close to the interatomic distance, adhesion occurs between the faying surfaces of the metals. The adhered part of a lower strength metal is detached by the adhered part of a higher strength metal, causing flakes of metal as shown in **Fig. 2.1**.

(2) Impact wear

Repetitive striking actions of solid surfaces cause pitting damage. The pitting damage is the removal or displacement of material by fatigue loading, forming cavities in the surface as shown in **Fig. 2.2**.

(3) Abrasive wear

Abrasive wear is caused by granular solids scratching, indenting and colliding against the surface of a metal, thereby detaching the surface gradually in flakes. Abrasive wear can be classified into "abrasion" and "erosion." Abrasion can further be classified, according to the extent of stress applied on the surfaces, as scratching abrasion, grinding abrasion, and gouging abrasion as depicted in **Figs. 2.3, 2.4, and 2.5**.

(4) Erosion

Erosion is generally referred to as the mechanical wear of a metal caused by collision of a fluid as shown in **Fig. 2.6**. The fluid may or may not contain fine granular solids. The erosion caused by the impact stresses raised by explosion of bubbles in a fluid is referred, particularly, to as "cavitation erosion."

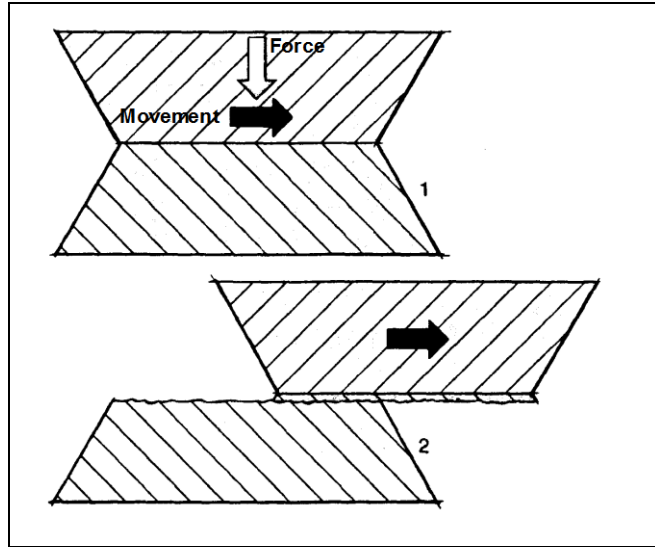

Fig. 2.1 — Adhesive wear: the adhesion occurred in the metal interface causes detachment of a lower-strength metal
(Fig source: *Welding Design & Fabrication*)

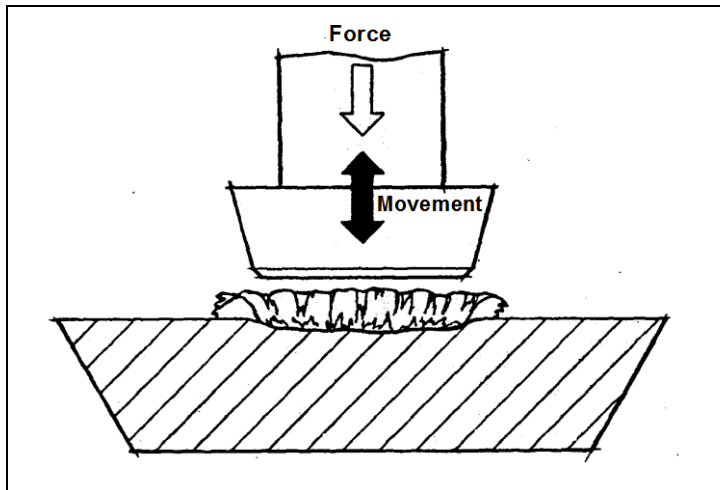

Fig. 2.2 — Impact wear: A repetitive striking action of metals causes removal of a lower-strength metal by fatigue
(Fig source: *Welding Design & Fabrication*)

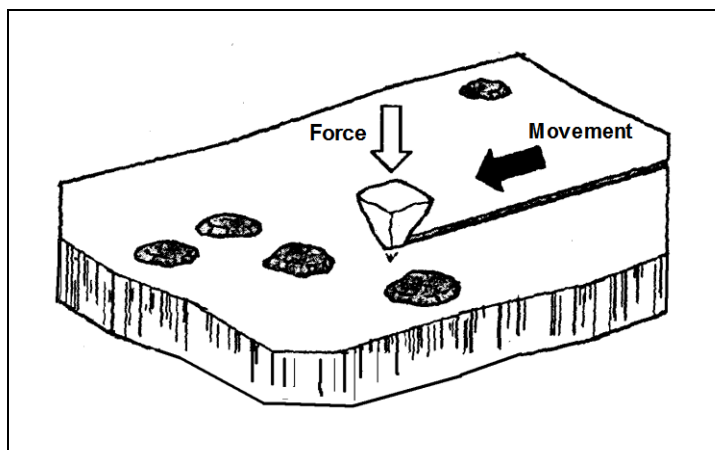

Fig. 2.3 — Scratching wear: A scratching action of granular solids against a metal surface under low or medium stresses causes gradual detachment of the metal in flakes
(Fig source: *Welding Design & Fabrication*)

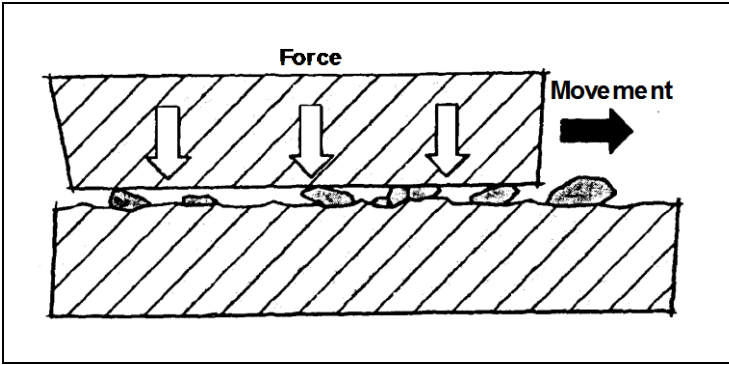

Fig. 2.4 — Grinding abrasion: A grinding action of granular solids indenting against a metal surface under medium or high stresses causes gradual removal of the metal. (Fig source: *Welding Design & Fabrication*)

Fig. 2.5 — Gouging abrasion: A collision of rocky solids against a metal surface under high stresses causes quicker, larger-mass removal of the metal by the shearing stresses. (Fig source: *Welding Design & Fabrication*)

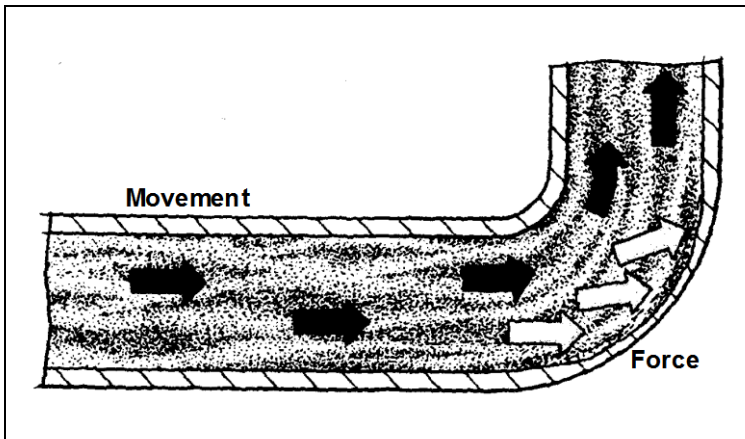
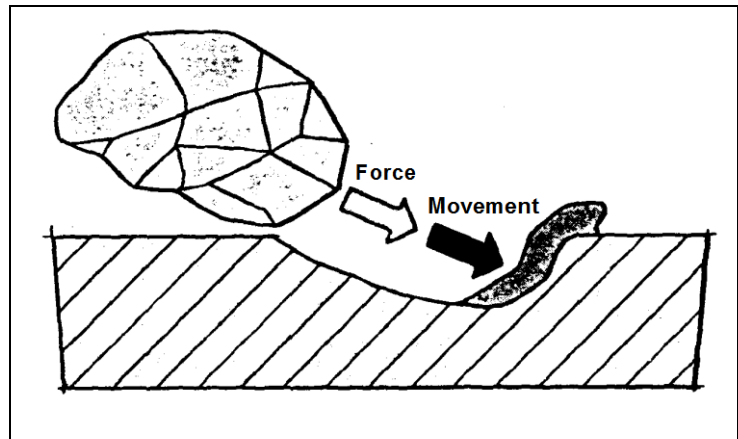

Fig. 2.6 — Erosion: A collision of a fluid can cause removal of metal. The kind of fluid can classify the erosion into sand erosion, cavitation erosion, erosion corrosion and rain erosion. (Fig source: *Welding Design & Fabrication*)

3. Weldability of base metals

The machinery parts designed for better wear-resistance without hardfacing necessarily use special steels such as medium-carbon steel, high-carbon steel, low-alloy steel and high-alloy steel as shown in **Table 3.1**, except where good-weldable low-carbon steel is used provided that hardfacing is applied on production. The special steels have, in general, poor weldability due to self-hardening in arc welding. The degree of hardenability can be estimated by the carbon equivalent. With a higher carbon equivalent, the hardness of the heat-affected zone of the base metal becomes higher, which in turn becomes more susceptible to cold cracking. In order to prevent cold cracking of a weld, preheating the base metal is quite an effective measure in addition to using low-diffusible-hydrogen welding consumables.

Table 3.2 shows a guide to proper preheat and interpass temperatures arranged as a function of the carbon equivalent of steels and the type of alloy. However, in welding high manganese steels and Cr-Ni stainless steels, preheat must not be applied and the interpass temperature should be kept lower in order to prevent high temperature embrittlement.

Table 3.1 — Examples of steel materials used for various machinery components

Machinery component	Typical material ⁽¹⁾	Corresponding JIS No. and grade		Nominal Ceq ⁽²⁾ (%)
Track rollers	Carbon steel (0.50C)	G 4051:09	S50C	0.64
Track link	Carbon steel (0.45C)	G 4051:09	S45C	0.59
	Low-alloyed steel (0.4C-1Cr)	G 4053:08	SCr440	0.75
	Low-alloyed steel (0.3C-1Cr-0.2Mo)	G 4053:08	SCM435	0.76
Dipper teeth	High-Mn steel casting (1C-13Mn)	G 5131:08	SCMnH2	NA
	Low-alloyed steel (0.4C-1Cr)	G 4053:08	SCr440	0.75
Dredger cutter knives	Carbon steel casting (0.4C)	G 5101:91	SC480	0.40
	Low alloy steel casting (0.3C-1.3Mn)	G 5111:91	SCMn2	0.54
	Carbon steel (0.45C)	G 4051:09	S45C	0.59
	Low-alloyed steel (0.5C-1.8Ni-0.8Cr-0.2Mo)	G 4053:08	SNCM447	0.94
Dredger pump casing	Carbon steel casting (0.3C)	G 5101:91	SC450	0.35
	Low alloy steel casting (0.2C-1Cr-0.2Mo)	G 5111:91	SCCrM1	0.64
Crusher jaw	High-Mn steel casting (1C-13Mn-2Cr)	G 5131:08	SCMnH11	NA
Gear	Carbon steel (0.40C)	G 4051:09	S40C	0.54
	Low-alloyed steel (0.3C-1.8Ni-0.8Cr-0.2Mo)	G 4053:08	SNCM431	0.78
	Low-alloyed steel (0.4C-1Cr-0.2Mo)	G 4053:08	SCM440	0.81
Forging punch	Carbon tool steel (1.0C)	G 4401:09	SK3	1.12
	Alloy tool steel (0.3C-5Cr-1Mo-0.4V)	G 4404:06	SKD6	NA
	High speed tool steel (0.8C-18W-5Co-4Cr-1V)	G 4403:06	SKH3	NA
Valve	Carbon steel casting (0.3C)	G 5101:91	SC450	0.35
	Low alloy steel casting (0.2C-1Cr-0.2Mo)	G 5111:91	SCCrM1	0.64
	Corrosion-resistant cast steel (19Cr-12Ni-2Mo)	G 5121:03	SCS14	NA

Note:

- (1) Descriptions of typical materials are as per the corresponding JIS grades, and the chemical compositions in the parentheses are for rough guidance to the JIS grades.
- (2) Ceq (%) = C + Mn/6 + Si/24 + Cr/5 + Mo/4 + Ni/15; NA: Non-applicable

Table 3.2 — A guide to proper preheat and interpass temperatures as a function of the carbon equivalent or the type of high alloy of base metals

Type of steel	Carbon equivalent ⁽¹⁾ (%)	Preheat and interpass temperature (°C)
Carbon steel Low alloy steel	0.3 max	100 max
	Over 0.3 to 0.4 max	100 min
	Over 0.4 to 0.5 max	150 min
	Over 0.5 to 0.6 max	200 min
	Over 0.6 to 0.7 max	250 min
	Over 0.7 to 0.8 max	300 min
	Over 0.8	350 min
High Cr steel	Non-applicable	400 min
13%Mn steel	Non-applicable	No preheat, Interpass: fast cooling
Cr-Ni stainless steel	Non-applicable	No preheat, Interpass: 150 max

Note: (1) Ceq (%) = C + Mn/6 + Si/24 + Cr/5 + Mo/4 + Ni/15

4. Welding consumables for hardfacing

Various types of hardfacing arc welding consumables are available. The JIS standard specifies Z 3251:2006 (Covered Electrodes for Hardfacing) for shielded metal arc welding and Z 3326:2007 (Arc Welding Flux Cored Wires for Hardfacing) for gas shielded metal arc welding. The AWS standard specifies A5.13:2010 (Surfacing Electrodes for Shielded Metal Arc Welding) for covered electrodes and A5.21:2011 (Bare Electrodes and Rods for Surfacing) for solid, metal-cored and flux-cored electrodes and rods. In addition, welding consumables of many brands with proprietary compositions and forms (including wires, strips and fluxes for submerged arc welding) are available from suppliers.

The alloying elements and hardness of covered electrodes specified by JIS Z 3251 are shown in **Tables 4.1** and **4.2**, respectively. Those of flux-cored wires specified by JIS Z 3326 are shown in **Tables 4.3** and **4.4**, respectively.

Table 4.1 — Classification of hardfacing covered electrodes by chemical composition (%) of deposited metals (Excerpted from JIS Z 3251:2006)

Classification	C	Si	Mn	Ni	Cr	Mo	W	Fe	Co	Others
DF2A	0.30	1.5	3.0	—	3.0	1.5	—	Bal.	—	1.0
DF2B	0.30-1.00	1.5	3.0	—	5.0	1.5	—	Bal.	—	1.0
DF3B	0.20-0.50	3.0	3.0	—	3.0-9.0	2.5	2.0	Bal.	—	1.0
DF3C	0.50-1.50	3.0	3.0	—	3.0-9.0	2.5	4.0	Bal.	—	2.5
DF4A	0.30	3.0	4.0	6.0	9.0-14.0	2.0	2.0	Bal.	—	2.5
DF4B	0.30-1.50	3.0	4.0	3.0	9.0-14.0	2.0	2.0	Bal.	—	2.5
DF5A	0.50-1.00	1.0	1.0	—	3.0-5.0	4.0-9.5	1.0-7.0	Bal.	—	4.0
DF5B	0.50-1.00	1.0	1.0	—	3.0-5.0	—	16.0-19.0	Bal.	4.0-11.0	4.0
DFMA	1.10	0.8	11.0-18.0	3.0	4.0	2.5	—	Bal.	—	1.0
DFMB	1.10	0.8	11.0-18.0	3.0-6.0	0.5	—	—	Bal.	—	1.0
DFME	1.10	0.8	12.0-18.0	6.0	14.0-18.0	4.0	—	Bal.	—	4.0
DFCrA	2.5-6.0	3.5	7.5	3.0	20.0-35.0	6.0	6.5	Bal.	5.0	9.0
DFWA	2.0-4.0	2.5	3.0	3.0	3.0	7.0	40.0-70.0	Bal.	3.0	2.0
DCCrA	0.70-1.40	2.0	2.0	3.0	25.0-32.0	1.0	3.0-6.0	5.0	Bal.	0.5
DCCrB	1.00-1.70	2.0	2.0	3.0	25.0-32.0	1.0	7.0-9.5	5.0	Bal.	0.5
DCCrC	1.75-3.00	2.0	2.0	3.0	25.0-33.0	1.0	11.0-14.0	5.0	Bal.	0.5
DCCrD	0.35	1.0	1.0	3.5	23.0-30.0	3.0-7.0	1.0	5.0	Bal.	0.5

Note: Single values are maximum. P and S are also specified to be 0.03% max., respectively, for all the classifications.

Table 4.2 — Hardness number for classifying the hardness of deposited metals (Excerpted from JIS Z 3251:2006)

Classified hardness No.	Vickers (H _V)	Rockwell		Brinell (H _B)
		B-scale (H _{RB})	C-scale (H _{RC})	
200	250 max	100 max	22 max	238 max
250	200-300	92-106	11-30	190-284
300	250-350	100-109	22-36	238-331
350	300-400	—	30-41	284-379
400	350-450	—	36-45	331-425
450	400-500	—	41-49	379-465
500	450-600	—	45-55	—
600	550-700	—	52-60	—
700	650 min	—	58 min	—

Table 4.3 — Classification of hardfacing flux-core wires by chemical composition (%) of deposited metals (Excerpted from JIS Z 3326:2007)

Classification	C	Si	Mn	Ni	Cr	Mo	V	W	Nb	Al	Fe	Other
YF2A-C YF2A-G	0.30	1.5	3.0	—	3.0	1.5	—	—	—	—	Bal.	1.0
YF3B-C YF3B-G	0.10- 1.50	3.0	3.0	—	3.0- 10.0	4.0	2.0	4.0	—	—	Bal.	2.0
YF4A-C YF4A-G	0.15	1.0	3.0	8.0	10.0- 14.0	2.0	—	—	—	—	Bal.	2.0
YF4B-C YF4B-G	0.15- 0.50	1.0	3.0	—	10.0- 14.0	2.0	—	—	—	—	Bal.	2.0
YFMA-C YFMA-G	1.10	0.8	11.0- 18.0	3.0	4.0	2.5	—	—	—	—	Bal.	1.0
YFME-C YFME-G	1.10	0.8	12.0- 18.0	6.0	14.0- 18.0	4.0	—	—	—	—	Bal.	4.0
YFCrA-C YFCrA-G	2.5- 6.0	3.5	3.0	—	20.0- 35.0	6.0	—	6.5	7.0	—	Bal.	5.0
YF2A-S	0.40	1.5	3.0	—	3.0	1.5	—	—	—	3.0	Bal.	1.0
YF3B-S	0.10- 1.50	3.0	3.0	—	3.0- 10.0	4.0	—	4.0	—	3.0	Bal.	2.0
YFCrA-S	2.5- 6.0	3.5	3.0	—	20.0- 35.0	6.0	—	6.5	7.0	—	Bal.	5.0

Note: Single values are maximum. P and S are also specified to be 0.03% max., respectively, for all the classifications.

Table 4.4 — Hardness number for classifying the hardness of deposited metals (Excerpted from JIS Z 3326:2007)

Classified hardness No.	Vickers hardness (H _V)
200	250 max
250	200-300
300	250-350
350	300-400
400	350-450
450	400-500
500	450-600
600	550-700
700	650-800
800	750 min

For the practicalities in usage, the grouping of the welding consumables by the microstructure of weld metal and characteristic alloying elements is more common and useful to select an appropriate welding consumable, than by the standardized classifications, as shown in **Table 4.5**. The typical microstructures of these deposited metals are shown in **Photo 4.1**.

Table 4.5 — Hardfacing welding consumables classified by the type of deposited metal

Type of deposited metal		Vickers hardness range	Kobe Steel's trade designations for SMAW	JIS Z 3251:2006 classification ⁽¹⁾	Kobe Steel's trade designations for FCAW	JIS Z 3326:2007 classification ⁽²⁾
Pearlitic type		200-400	HF-240	DF2A-250-R	DW-H250	YF2A-C-250
			HF-260	DF2A-300-B	—	—
			HF-330	DF2A-350-R	DW-H350	YF2A-C-350
			HF-350	DF2A-400-B	—	—
Martensitic type		350-800	HF-450	DF2A-450-B	DW-H450	YF3B-C-450
			HF-500	DF2B-500-B	—	—
			HF-600	DF2B-600-B	DW-H600	YF3B-C-600
			HF-650	DF3C-600-B	—	—
			HF-700	DF3C-600-B	DW-H700	YF3B-C-600
			HF-800K	DF3C-700-B	—	—
			—	—	DW-H800	YF3B-C-800
13%Cr stainless steel type		350-500	HF-13	DF4A-450-B	—	—
			CR-132	—	DW-H132	YF4A-C-350
			CR-134	—	DW-H134	YF4A-C-350
			CR-136	—	—	—
Semi-austenitic type		500-700	HF-12	DF3C-500-B	—	—
High-Mn austenitic type	13%Mn	150-500	HF-11	DFMA-250-B	DW-H11	YFMA-C-250
	16%Mn-16%Cr	200-400	HF-16	DFME-300-B	DW-H16	YFME-C-300
High-Cr iron type		600-800	HF-30	DFCrA-700-B	DW-H30	YFCrA-C-700
			—	—	DW-H30MV	YFCrA-C-800
Tungsten carbide type		800-1200	HF-950	—	—	—
			HF-1000	—	—	—
Co-Cr-W alloy type		400-600	—	DCoCrA	—	—
			—	DCoCrB	—	—
			—	DCoCrC	—	—

Note:

(1) Classification system: e.g., DF2A-250-R

- D: designates a covered electrode.
- F2A: designate characteristic chemical elements.
- 250: indicates the hardness classification as per Table 4.2.
- R: designates the type of coating flux (R: high titania, B: lime basic, BR: lime titania, S: special)

(2) Classification system: e.g., YF2A-C-250

- Y: designates a welding wire.
- F: designates a flux-cored wire.
- 2A: designate chemical composition
- C: designates the shielding gas composition (C: CO₂ or Ar+CO₂, G: non-specified, S: self-shielded).
- 250: indicates the hardness classification as per Table 4.4.

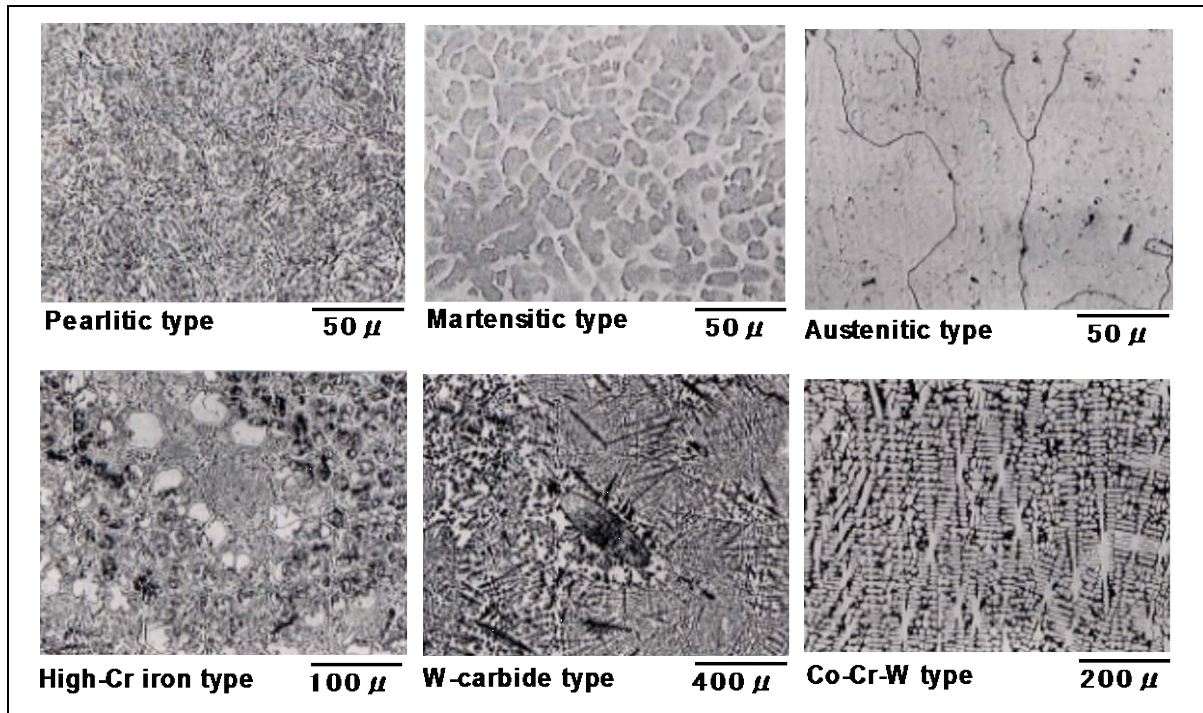

Photo 4.1 — Typical microstructures of specific hardfacing deposited metals
(The microstructure of hardfacing alloys consists, depending on the chemical composition, of hard-phase precipitates such as Fe, Cr, Mo, W and V carbides and Fe-borides in the softer iron or cobalt-base alloy matrix.)

5. Characteristics of hardfacing filler metals

As introduced in the previous section, the types of hardfacing filler metals vary in a wide range as follows: relatively low-hardness pearlitic type up to very hard tungsten carbide type and high chromium iron type, including non-ferrous cobalt-base alloys. These filler metals feature very different characteristics. Therefore, in order to select an appropriate hardfacing filler metal for a certain application, it is indispensable to know the characteristics of these varieties of filler metals sufficiently.

5.1 Pearlitic type

This type of filler metal deposits a pearlitic microstructure metal by cooling the weld in still air after welding. The pearlitic deposited metal features comparatively low hardness. This is why it is not resistible against scratching abrasion in comparison with other types of hardfacing filler metals. Rather, it is suitable for underlaying before hardfacing harder filler metals, and is used for hardfacing the work that has to be machined after welding.

This type of deposited metal features quench hardenability; therefore, it can be hardened by induction hardening and flame hardening to improve the wear resistance of the weld. Typical applications include shafts, gears, and wheels.

5.2 Martensitic type

This type of filler metal contains sufficient amounts of carbon and alloying elements so that the deposited metal transforms to martensitic microstructure in the as-welded condition in still air after welding. The martensitic deposited metal offers excellent resistance to wear due to its very high hardness. On the other hand, it is not resistible to impact wear because of its lower ductility.

The martensitic type family includes boron-martensitic type that exhibits higher hardness due to the boron content, and γ -rich martensitic (semi-austenitic) type that features excellent ductility due to the content of residual austenite.

Typical applications include idlers, rollers and truck links for bulldozers, bucket edges, tamping dies, mixer blades, cutter knives, and casings.

5.3 13%Cr stainless steel type

This type of filler metal provides a martensitic deposited metal, which exhibits excellent metal-to-metal wear resistance at high temperatures. Its variation includes 13%Cr-2%Ni, 13%Cr-4%Ni, and 13%Cr-6%Ni formulas, which offer excellent heat-crack resistance with better corrosion resistance. Typical applications include valve sheets, agitator propellers, turbine blades and casings, and rollers for steel mills.

5.4 High-Mn austenitic type

This type of filler metal features an austenitic microstructure deposited metal at room temperature. Its variation includes 0.8%C-13%Mn and 0.7%C-16%Mn-16%Cr formulas. The 0.8%C-13%Mn type offers high ductility and high work-hardenability. This is why it exhibits excellent resistance against impact-wear and gouging wear, but poor resistance to grinding abrasion. The 0.7%C-16%Mn-16%Cr type maintains high hardness at elevated temperatures over 700°C, which can resist high-temperature wear and impact-wear.

Typical applications for 0.8%C-13%Mn type include crusher hammers and jaws. The 0.7%C-16%Mn-16%Cr type filler metals are used for hot shears and saws, rolling mill guides, and hot forging dies.

5.5 High-Cr iron type

This type of filler metal features the main composition of 2.5-6%C and 20-35%Cr in its deposited metal. This deposited metal exhibits the microstructure consisting of a large amount of Cr-carbides precipitated in a cast iron matrix. The hardness of the deposited metal is around Hv 700; however, its wear resistance is superior to that of conventional Hv 700-class martensitic deposited metals because of very hard Cr-carbides (Hv: 1700-2000) dispersed in hexagonal or acicular shape as in Photo 4.1, in the matrix. On the other hand, the resistance to impact wear is low. Typical applications include crusher rotor and sand pump casing.

5.6 Tungsten carbide type

The deposited metal of this type of filler metal features the microstructure consisting of very hard, tungsten carbides (Hv: 1900-2500) that precipitate or intervene in the matrix; therefore, its microscopic hardness exhibits varied measurements. This type of deposited metal exhibits very good resistance against heavy abrasive wear, but poor impact resistance. Typical applications include shovel teeth, cutter knives, concrete cutters, and earth drills.

5.7 Co-Cr-W type

This type of filler metal is commonly known as Stellite, the main alloying element of which is Co, containing additionally C, Cr, and W. Its deposited metal features stable microstructure even at high temperatures, maintaining its high hardness. It also offers excellent resistance against oxidation and corrosion. Typical applications include valve seats and discs.

6. Wear resistance of hardfacing weld metals

Hardfacing applications range from severe abrasive wear services, such as rock crushing and pulverizing, to minute wear services that require minimization of metal-to-metal wear, such as control valves. Therefore, in comparison of hardfacing weld metals on wear resistance, the final judge should be done with practical data obtained in the field services under specific conditions. However, laboratory tests are also useful to select or develop better filler metals by comparing the wear resistance of various weld metals in the testing conditions with the field parameters applied. The following sections discuss results of two laboratory tests and one field-service test for comparing the various types of filler metals shown in **Table 6.1**.

Table 6.1 — Typical characteristics of specimens for testing wear resistance

Type of deposited metal	Welding process	Kobe Steel's trade designation	Typical chemical composition (%)									Hardness, Hv
			C	Si	Mn	Cr	Mo	Ni	W	V	B	
Pearlitic type	SMAW	HF-260	0.16	0.7	1.8	—	—	—	—	—	—	237
		HF-350	0.22	0.5	1.2	1.2	—	—	—	—	—	327
Martensitic type	SMAW	HF-450	0.20	1.2	0.4	2.5	0.5	—	—	0.3	—	449
		HF-500	0.33	1.4	1.2	—	0.8	—	—	0.3	—	482
		HF-600	0.44	0.9	2.3	2.5	—	—	—	—	—	564
		HF-650	0.62	0.9	0.9	5.1	1.2	—	1.2	0.6	—	634
		HF-700	0.53	0.8	0.8	5.1	2.2	—	—	—	—	668
		HF-800K	0.89	1.6	1.2	3.8	—	—	2.4	—	0.3	753
	FCAW	DW-H800	1.10	0.8	2.0	3.9	—	—	1.9	—	0.5	817
	SAW	US-H450N	0.17	0.7	2.2	2.8	0.7	—	—	0.4	—	462
		US-H600N	0.38	0.6	1.9	7.0	4.4	—	—	—	—	586
13%Cr stainless steel type	SMAW	HF-13	0.13	0.4	0.7	13.0	1.0	1.0	—	—	—	406
Semi-austenitic type	SMAW	HF-12	0.59	0.4	1.3	7.1	1.1	—	—	—	—	572
High-Mn austenitic type	SMAW	HF-11	0.76	0.4	13.2	—	—	—	—	—	—	222
		HF-16	0.76	0.6	15.3	15.4	1.5	1.5	—	0.4	—	319
High-Cr iron type	SMAW	HF-30	5.00	0.4	1.2	32.7	2.2	—	—	—	—	760
	FCAW	DW-H30	2.92	0.8	0.2	24.1	—	—	—	—	0.4	755
		DW-H30MV	5.09	2.11	0.1	22.5	0.9	—	—	2.6	0.2	824
W-carbide type	SMAW	HF-950	3.5	0.3	1.8	—	—	—	44	—	—	915
		HF-1000	2.8	0.5	1.7	—	—	—	56	—	—	1038

6.1 Resistance to scratching abrasion

Fig. 6.1 shows the principles of the testing method and parameters specified by ASTM G65 for testing the wear resistance against scratching without impact stress. In this testing procedure, a certain amount of silica sand is fed in between the testing specimen and the rubber-lining wheel. The silica sand stuck on the surface of the rubber wheel scratches the specimen being pressed by the weight towards the rubber wheel. For the latest information of the testing method, refer to ASTM G65:04(2010) (Standard Test Method for Measuring Abrasion Using the Dry Sand/Rubber Wheel Apparatus)

Fig. 6.2 shows wear losses as a function of hardness. Lower wear loss can be referred to as better wear resistance. The overall data exhibit a certain tendency, in which the wear loss decreases as the hardness of the weld metals increases. However, around 700-800 of Vickers hardness, the wear loss markedly varies among filler metals with different alloy formulas.

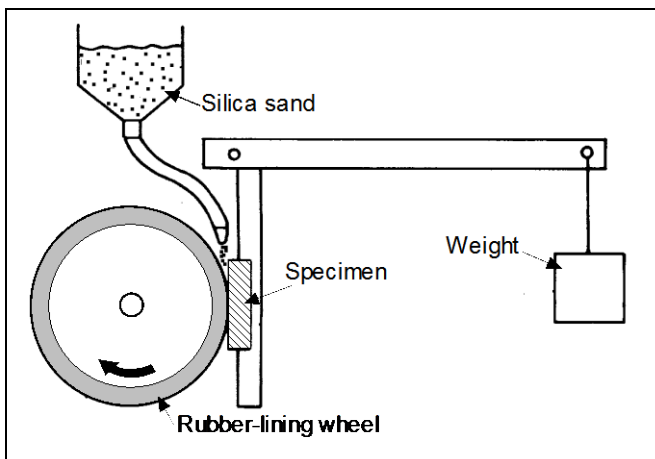

Fig. 6.1 — A schematic arrangement of ASTM G65 abrasion test method

Testing parameters:

- Abrasive: silica sand
- Grain size of abrasive: 48 x 65 mesh
- Feeding rate of abrasive: 250-350 g/min
- Load for pressing the specimen: 130 N
- Rotation speed of wheel: 200 rpm
- Equivalent length of abrasion: 4000 m
- Size of specimen: 12T x 25W x 75L mm

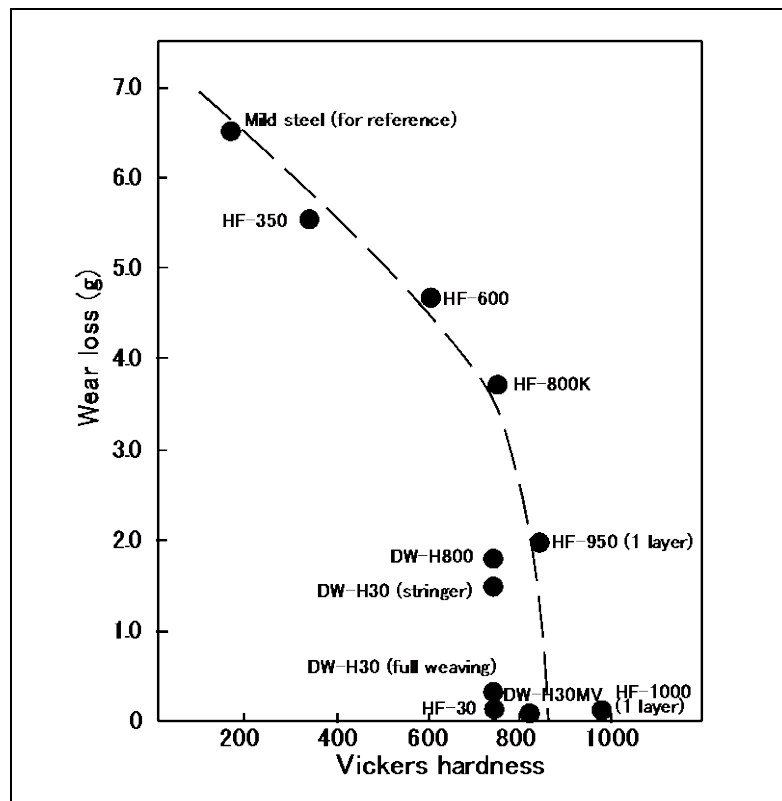

Fig. 6.2 — A comparison between various hardfacing filler metals on the scratching abrasion resistance of weld metals tested in accordance with ASTM G65

6.2 Resistance to abrasive-impact wear

Fig. 6.3 shows an arrangement of the abrasive-impact wear tester, test specimen profiles and testing conditions, which simulates a kind of pulverizer. In this test procedure, the test specimen is fixed on the axle, which rotates in the rough quartz grains put in the drum. For the first cycle test, 400g of quartz grains are put in the drum and the test specimen is rotated in the quartz for 15 minutes. For the second cycle test, the quartz grains are renewed and the test is continued for the same specimen. This testing cycle is repeated four times, and the total wear loss of the specimen is measured.

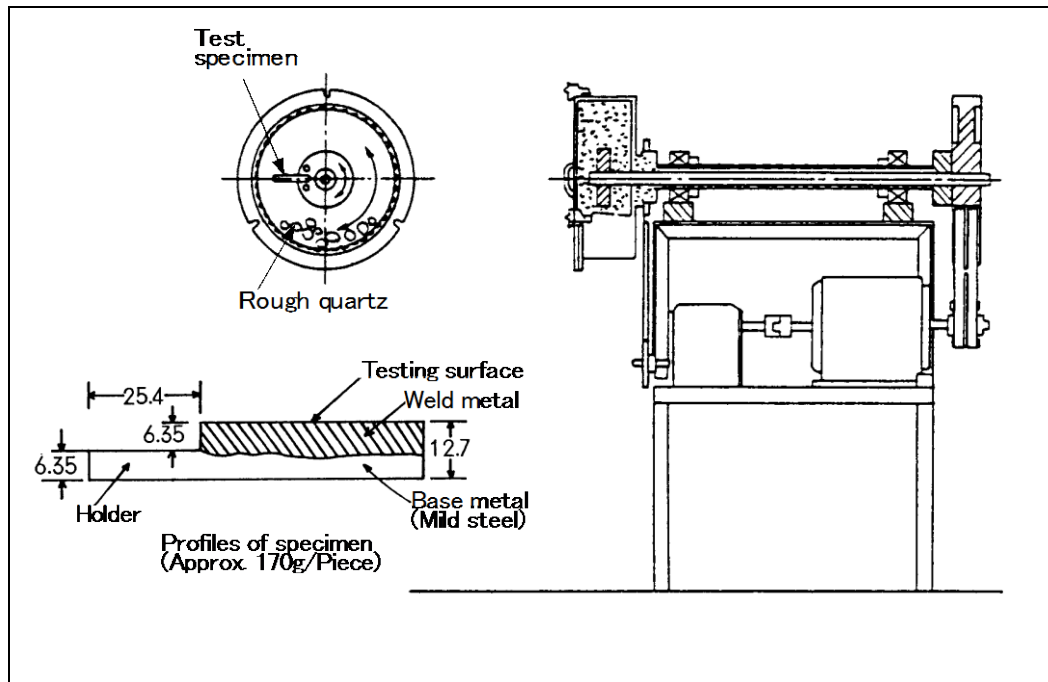

Fig. 6.3 — An abrasive-impact wear tester and testing specimen profiles

Testing conditions:

- Abrasive: rough quartz; • Rotation speed of drum: 70 rpm
- Grain size of abrasive: 13.5-19 mm; • Rotation speed of specimen: 632 rpm
- Amount of quartz: 400g/one time, • Test cycle: 15 minutes x 4 times

Fig. 6.4 shows the wear losses of various types of filler metals as a function of Vickers hardness. Lower wear loss can be referred to as better wear resistance. The overall data exhibit a certain tendency, in which the wear loss decreases as the hardness of the weld metals increases. However, among the weld metals having almost the same hardness, there are some variations in wear loss, which may have been affected by individual characteristic microstructure. In the case of HF-950 weld metal, although it features the highest hardness due to precipitates of tungsten carbides in the matrix, the specimen developed chips due to the low ductility during the test, thereby causing the worst result.

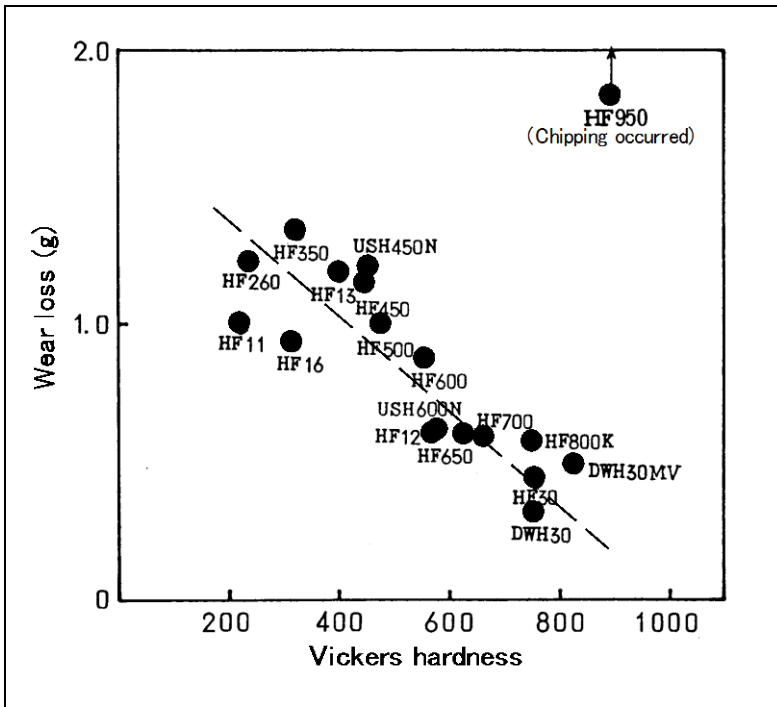

Fig. 6.4 — A comparison between various hardfacing filler metals on abrasive-impact wear resistance of weld metals as a function of Vickers hardness

6.3 Wear resistance of ripper tips

The ripper tips of bulldozers are subject to very severe abrasion with rocky hard soil in service. Fig. 6.5 shows wear resistance of several types of filler metals used for hardfacing ripper tips and tested during operation in the field. In this case, the main type of abrasion was the grinding abrasion under medium stresses, accompanied by low-stress scratching abrasion, high-stress gouging abrasion and abrasive impact. In this field-service test, a martensitic type weld metal containing residual austenite and carbides (HF-650) was proved to be best. These results are consistent, in tendency, with the laboratory-test data shown in Fig. 6.4.

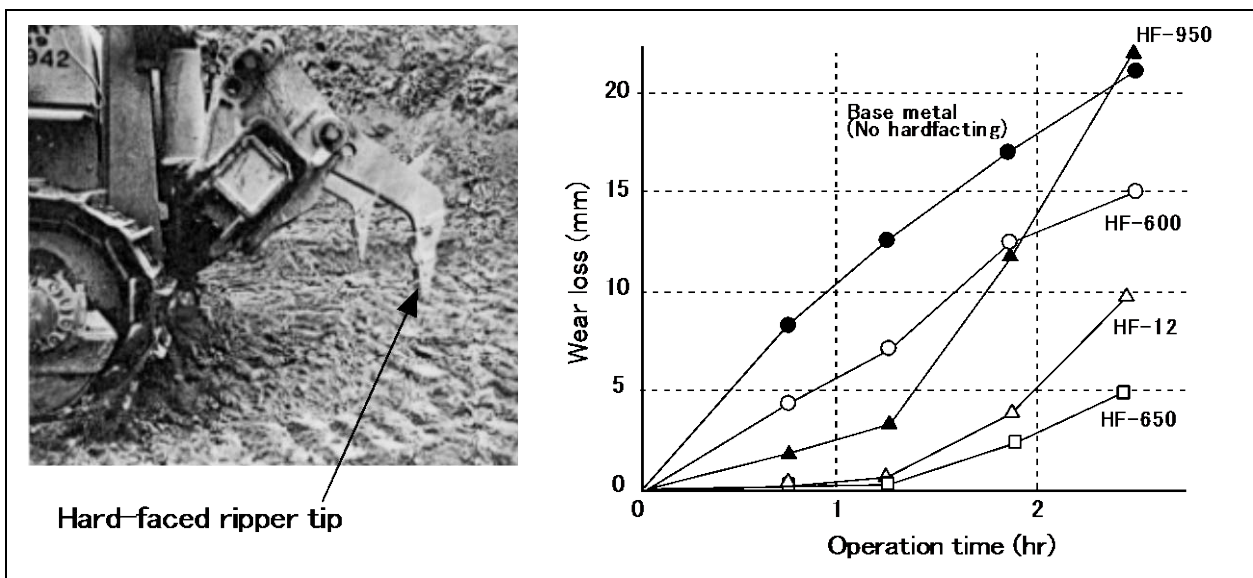

Fig. 6.5 — Results of field-service wear resistance test of ripper tips hard-faced with various types of filler metals

As discussed above, a higher-hardness filler metal is more resistant against scratching abrasion. In particular, precipitates of carbides in the matrix improve the wear resistance against scratching abrasion. However, in cases where abrasion is accompanied by impact stresses, the ductility of the weld metal becomes an important factor. Unlike the case of scratching abrasion, large-size precipitates of carbides can adversely affect the wear resistance because of lower ductility, which may cause chipping of the weld metal. In the case of erosion where fine particle abrasives are accompanied, the hardness of the matrix is more influential factor rather than the carbides.

In addition to the general guidance mentioned above, other environmental factors such as service temperature and corrosives may have to be taken into consideration in selection of the suitable filler metal for a specific application. **Table 6.2** is a general guide for the selection of the proper type of filler metal or deposited metal suitable for a specific application, as a function of the type of wear and other service factors.

Table 6.2 — A quick guide for selection of suitable filler metal or deposited metal for specific application

Type of filler metal or deposited metal		Type of wear and environmental factors ⁽¹⁾						
		MTM	ABR	HTW	CAV	COR	HTR	IMP
Pearlitic type		○	△	×	—	—	×	○
Martensitic type		○	○	△	—	×	△	△
13%Cr stainless steel type		○	△	○	○	○	○	△
Semi-austenitic type		○	○	△	△	△	△	△
High-Mn austenitic type	13%Mn	×	○	×	△	×	×	◎
	16%Mn-16%Cr	○	△	○	○	○	○	○
High-Cr iron type		△	◎	◎	×	○	○	×
Tungsten carbide type		×	◎	×	×	×	×	×
Co-Cr-W alloy type		○	○	◎	◎	◎	◎	△

Note: (1) MTM: metal-to-metal wear, ABR: abrasion, HTW: high-temp wear, CAV: cavitation, COR: corrosion, HTR: heat resistance, IMP: impact wear
 ◎: Excellent, ○: Good, △: Inferior, ×: Poor, —: Non-applicable

7. Essential factors for hardfacing procedure

The following sections discuss preheat and interpass temperatures, dilution by base metal, quenching and tempering temperatures, work-hardenability, underlaying, and patterned reinforcement in relation to the characteristics of hard-faced welds.

7.1 Preheat and interpass temperature

Preheating and interpass temperatures affect the hardness of hard-faced welds; **Fig. 7.1** shows how the effect of such temperatures varies depending on the type of filler metal. A pearlitic weld metal (HF-350) decreases its hardness as preheat and interpass temperatures increase. This is because an increase in the temperature causes a decrease in the cooling rate of the weld, which in turn affects the microstructure of the weld metal; that is, slow cooling causes precipitation of ferrite.

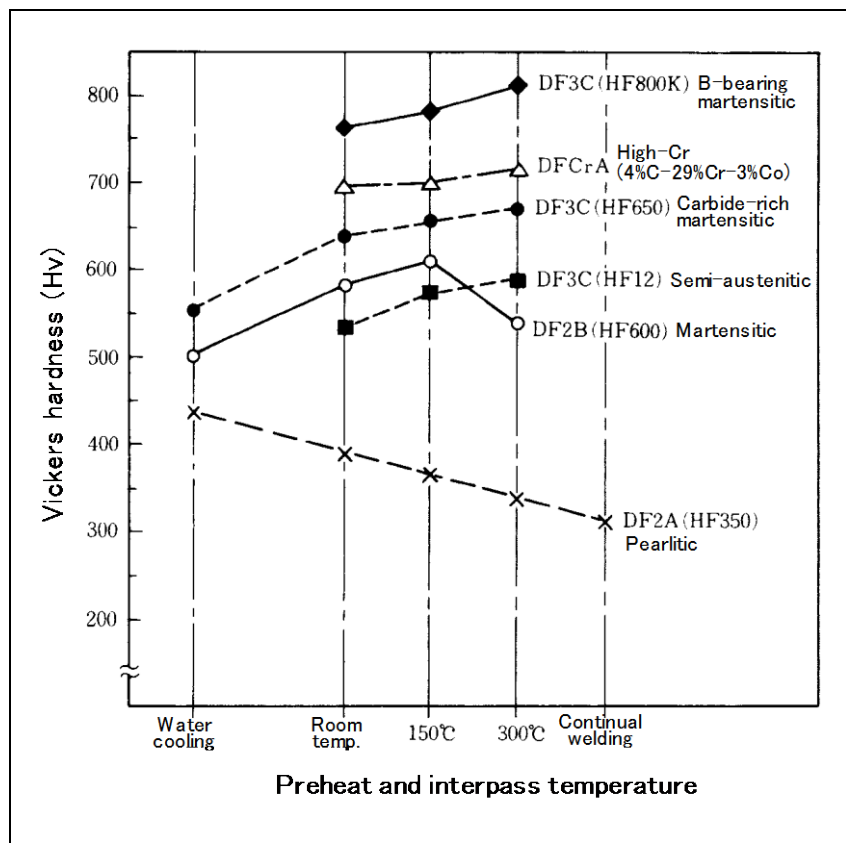

Fig. 7.1 — Effects of preheat and interpass temperatures on Vickers hardness of various types of weld metals

At very fast cooling rates as in water cooling, a martensitic weld metal (HF-600) contains residual austenite that decreases the hardness of the weld metal. In contrast, at slow cooling rates as with 300°C preheat and interpass temperature, the martensitic weld metal decreases its hardness due to precipitation of pearlite. Unlike HF-600, other martensitic filler metals of HF-650 and HF-800K contain much more alloying elements such as C, Cr, Mo, W, V, and B. Therefore, slow cooling (with high preheat and interpass temperatures) promotes the precipitation of carbide and boride in the weld metal matrix, thereby increasing the hardness of the weld metals. A γ -rich martensitic (semi-austenitic) filler metal, HF-12, exhibits lower hardness as compared with HF-600 when preheat and interpass temperatures are lower (room temperature and 150°C); however, HF-12 exhibits higher hardness than that of HF-600 when the temperatures increase to 300°C. This is because the amount of γ -phase (austenite) decreases and higher alloying elements such as C, Cr and Mo precipitate carbides, thereby increasing the hardness of the weld metal.

A high-Cr weld metal is not affected by preheat and interpass temperatures, maintaining almost the same hardness. Tungsten carbide type and Co-Cr-W type weld metals, though no data are included in Fig. 7.1, generally exhibit the same behavior as in the case of the high-Cr type.

High-Mn austenitic weld metals exhibit a very different behavior compared with other types of weld metals discussed above. That is, the slow cooling with high preheating and interpass temperatures may cause the carbide precipitation embrittlement of the weld metal and the heat-affected zone of the base metal, thereby causing the occurrence of cracking. Therefore, preheat must not be applied and interpass temperature must be controlled lower by employing a water-cooling or air-cooling procedure for each weld pass.

7.2 Dilution by base metal

In hardfacing, the chemical composition of the weld metal varies according to the ratio of dilution by the base metal; consequently, the microstructure of the weld metal varies, thereby affecting the hardness of the weld metal. **Fig. 7.2** shows the hardness distributions of each layer of hard-faced weld metals laid on carbon steel base metals.

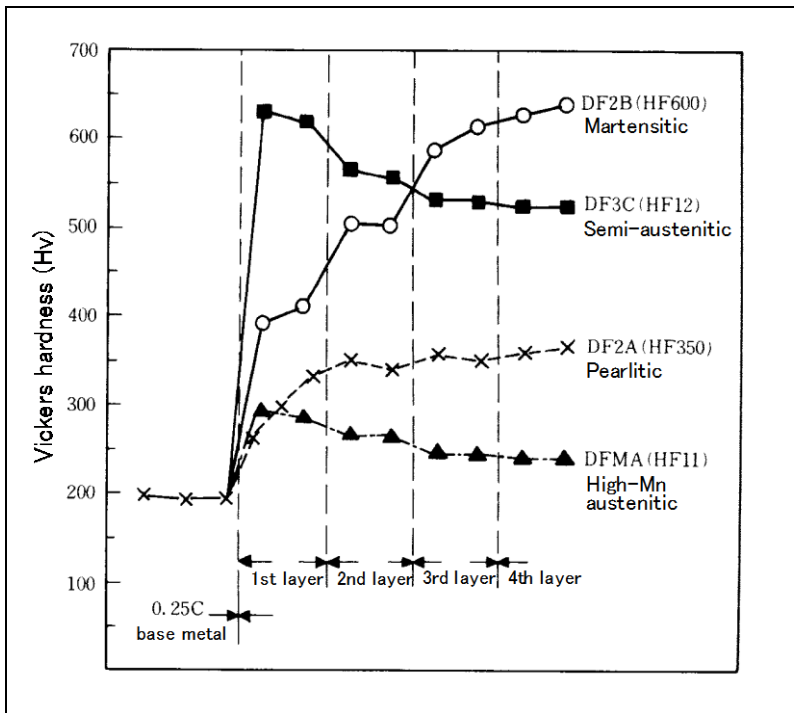

Fig. 7.2 — Hardness distributions in hard-faced weld metals of various types

In the case of martensitic and pearlitic weld metals, the effect of base metal dilution is significant; consequently, the first and second layers exhibit lower hardness than subsequent layers. Therefore, three or more layers are needed to obtain the designed hardness of individual type of filler metal.

In contrast, a semi-austenitic weld metal (HF-12) exhibits higher hardness in the first layer than subsequent layers; this is because the first layer weld metal consists mostly of martensite due to base metal dilution, thereby increasing the hardness. Similar to this, a high-Mn austenitic weld metal (HF-11) exhibits higher hardness in the first layer than subsequent layers; this is because the first layer weld metal precipitates martensite in the austenitic matrix, thereby increasing the hardness.

7.3 Quenching and tempering

Pearlitic weld metals are often quenched to improve the hardness. The weld metal after quenching is tempered generally in order to relieve the residual stresses raised by the quenching, thereby improving wear resistance, although the tempering decreases the hardness of the weld metal. **Fig. 7.3** shows the effects of quenching and of the tempering temperatures on the hardness of pearlitic weld metals.

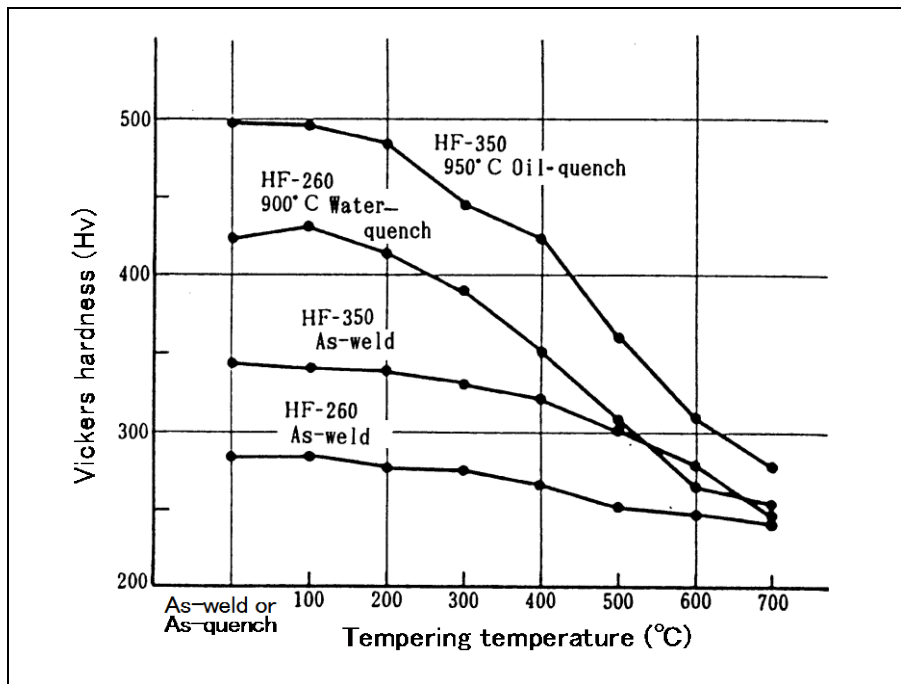

Fig. 7.3 — Effects of quenching and of the tempering temperatures on the hardness of pearlitic weld metals

7.4 Work-hardenability

In general, metals can be hardened by cold working. 13%Mn steel, in particular, has significant work-hardenability. Fig. 7.4 shows the hardness distribution of a 13%Mn weld metal cold-worked by hammering with a pneumatic hammer. It is obvious that 13%Mn weld metal rapidly increases its hardness as the hammering time increases up to approximately 10 minutes, and the longer-time hammering causes a gradual increase of hardness.

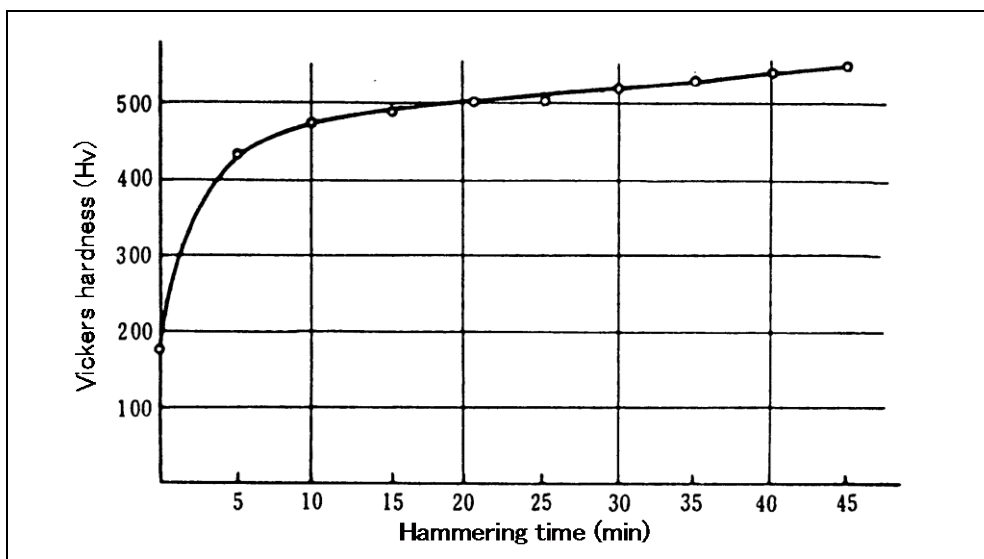

Fig. 7.4 — Effect of the hammering time on hardenability of 13%Mn weld metal

13%Mn steel shows almost the same behavior as the above-mentioned weld metal. **Fig. 7.5** shows the hardness distribution in the 13%Mn steel mantle of a gyratory crusher after a crushing operation. A marked increase in hardness can be observed at a depth of approximately 1.5mm or less from the surface of the mantle. The work-hardened layer should be removed before welding for repair or rebuilding in order to prevent cracking of the weld.

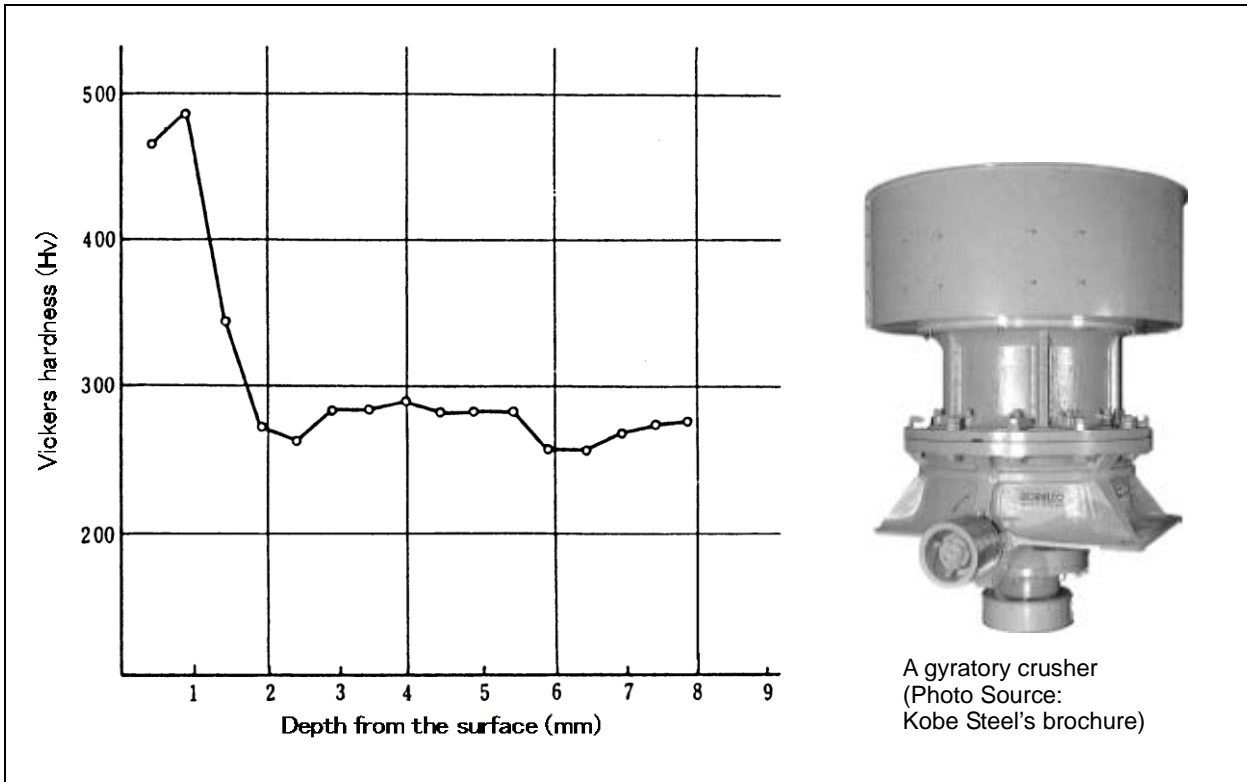

Fig. 7.5 — Hardness distribution in the 13%Mn steel mantle of a gyratory crusher after operation (The photo is just for reference, no relation to the hardness data)

7.5 Underlaying

Underlaying is often used before hardfacing in cases where the combination of a base metal and a hardfacing filler metal is prone to cause cracking or disbonding at the interface between the deposited metal and the base metal. The rebuilding or reclamation of a worn surface that is to be hard-faced subsequently is also referred to as underlaying. **Table 7.1** shows typical combinations of base metal, underlaying filler metal and hardfacing filler metal. **Figs. 7.6** and **7.7** show examples of underlaying and hardfacing procedures.

Table 7.1 — Typical combinations of base metal, underlaying filler metal, and hardfacing filler metal

Type of base metal	Type of underlaying filler metal	Type of hardfacing filler metal
<ul style="list-style-type: none"> • Carbon steel • Low-alloy steel 	<ul style="list-style-type: none"> • Low-hydrogen mild-steel type • Lower-hardness pearlitic type • Cr-Ni stainless steel type • Low-C, 16Mn-16Cr type 	<ul style="list-style-type: none"> • Higher-hardness pearlitic type • Martensitic type • High-Mn austenitic type • High-Cr iron type
<ul style="list-style-type: none"> • High-Mn steel 	<ul style="list-style-type: none"> • Cr-Ni stainless steel type • Low-C, 16Mn-16Cr type 	<ul style="list-style-type: none"> • 13%Mn type • Martensitic type

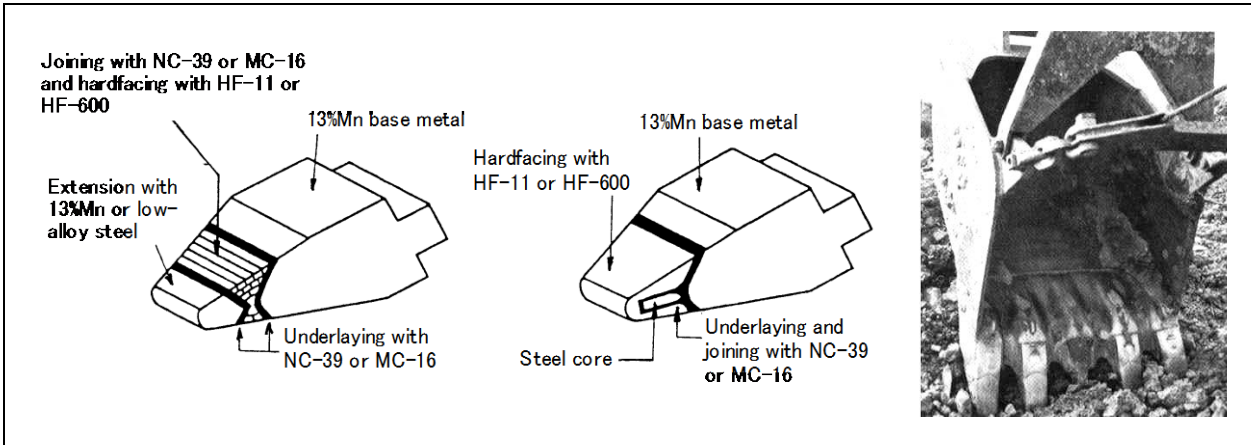

Fig. 7.6 — Underlaying and hardfacing procedures for rebuilding of dipper teeth (NC-39 is an E309 type austenitic stainless steel covered electrode)

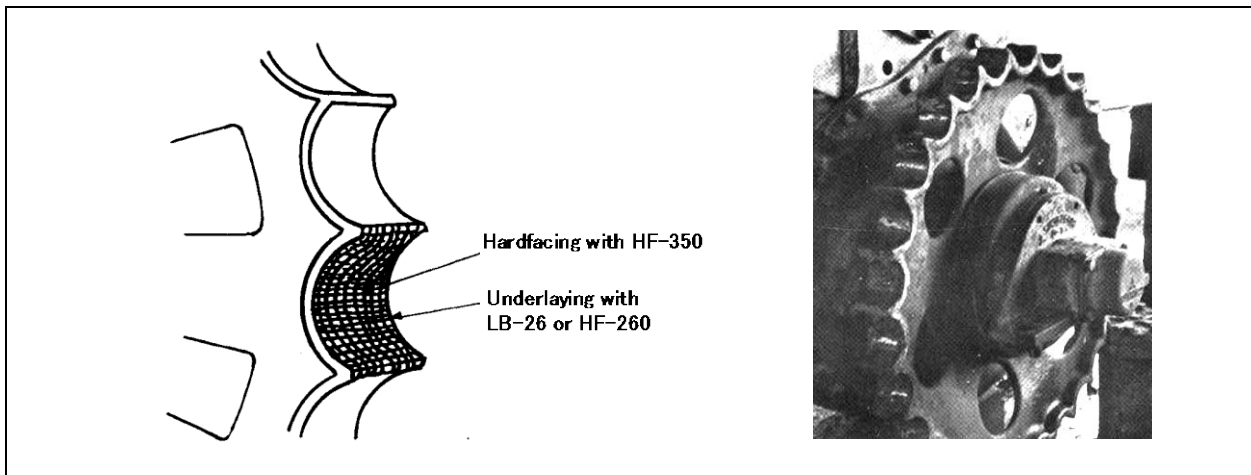

Fig. 7.7 — Underlaying and hardfacing procedures for rebuilding of a drive sprocket (LB-26 is an E7016 type covered electrode)

7.6 Pattered reinforcement

The amount of hardfacing can be minimized by using pattered reinforcement such as chequered, stringer, edging patterns, thereby decreasing welding distortion and furnishing very hard reinforcement on the ductile underlayers for better wear resistance. Fig. 7.8 shows examples of the patterned reinforcement used for hardfacing of dipper teeth. Photo 7.1 shows sugar mill hammer heads hard-faced with stringer reinforcement.

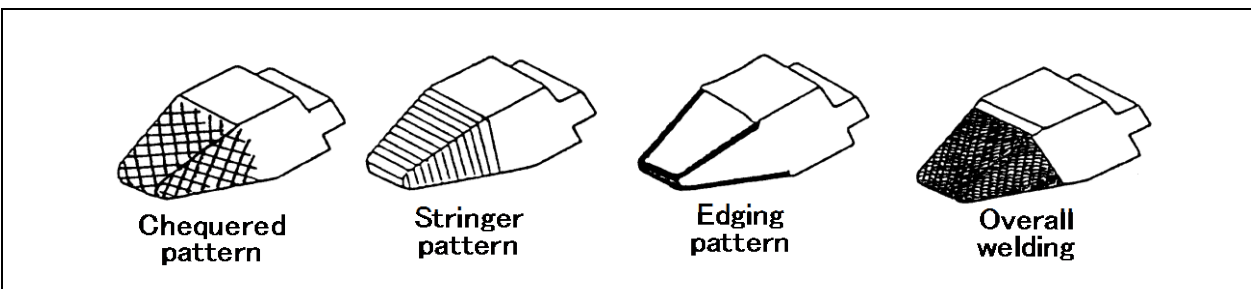

Fig. 7.8 — Variations of pattered reinforcement used for hardfacing of dipper teeth



Photo 7.1 — Sugar mill hammerheads hard-faced with a stringer pattern providing harder weld reinforcement on ductile underlayers for better wear resistance

8. Highly efficient hardfacing processes

The welding processes used in general hardfacing applications include

- Shielded metal arc welding (SMAW) with covered electrodes
- Gas shielded metal arc welding (GSMAW) with solid wires and flux-cored wires
- Submerged arc welding (SAW) with flux/flux-cored wire or strip electrode combinations
- Gas tungsten arc welding (GTAW) with filler rods
- Plasma transfer arc welding (PTAW) with metal powders

SMAW with covered electrodes is most widely used due to low equipment cost, high versatility in all positions and confined spaces, and many varieties of filler metals available. On the other hand, the manual nature of the process prevents improvement in the welding productivity; therefore, this process has gradually been superseded by semi-automatic GSMAW, automatic GSMAW and PTAW, SAW, and robotic GSMAW. **Fig. 8.1** shows a comparison between welding processes on deposition rate.

Of these welding processes, the use of GSMAW with flux-cored wires (**Photos 8.1, 8.2, and 8.3**) is increasing due to high deposition rates, good performance in robotic welding and many varieties of filler metals. The SAW processes with flux-cored wires (**Photos 8.4 and 8.5**) and strip electrodes (**Photo 8.6**) are used in such specific applications as crane wheels, tractor idlers, gyratory crusher cones, steel mill rollers and blast furnace bells due to high efficiency and better performance for large, hardfacing surfaces.

The PTAW process with metal powders (**Photo 8.7**) is used in such specific applications as engine valves, water valves, cutter knives, and rollers. With the PTAW process,

- Deposition rates can be 2-5 times as much as those with GTAW.
- Continuous feeding of metal powders facilitates automatic welding.
- Varieties of metal powders facilitate high-performance hard-faced weld metal.
- Shallow penetration can minimize the base metal dilution at 5-15%.
- The thickness of each layer can be accurately controlled in the range up to 5mm.

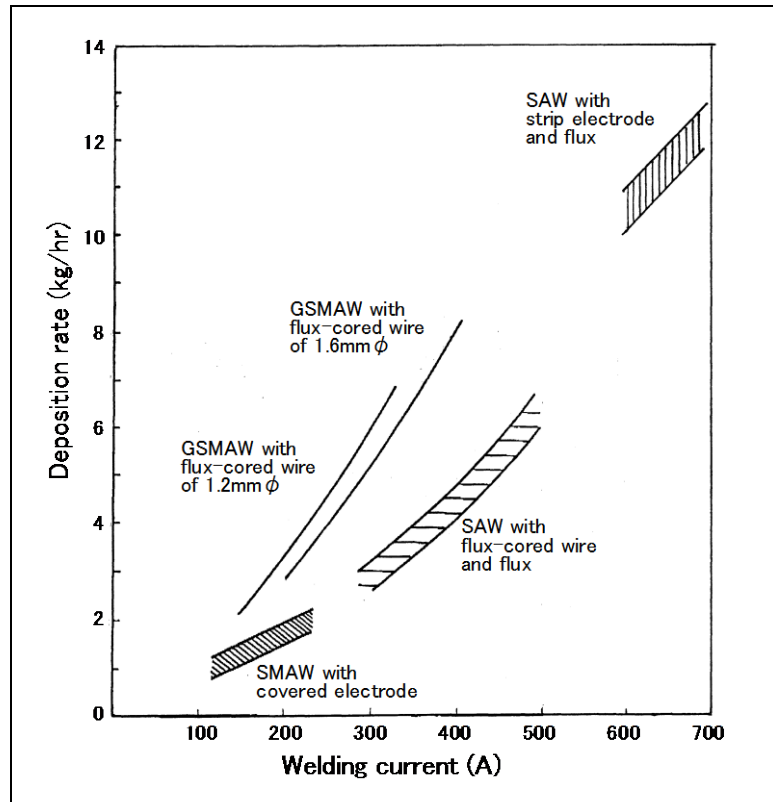

Fig. 8.1 — A comparison between hardfacing welding processes on deposition rate as a function of welding current

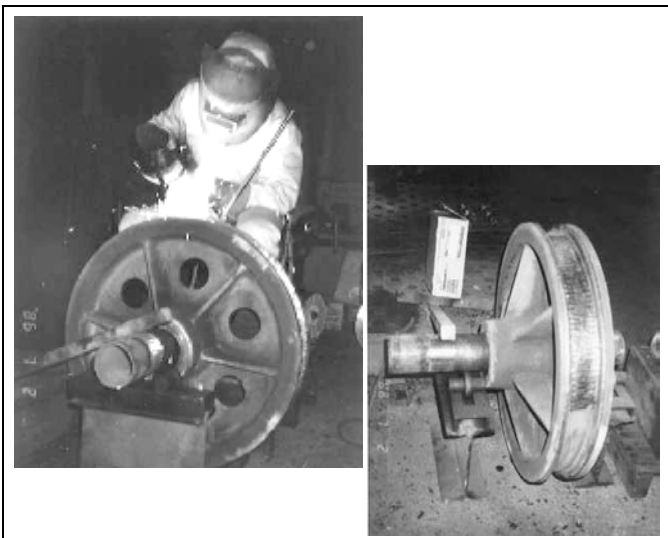

Photo 8.1 — GSMAW with a pearlitic type flux-cored wire (DW-H250), hardfacing a crane wheel of low-alloy steel

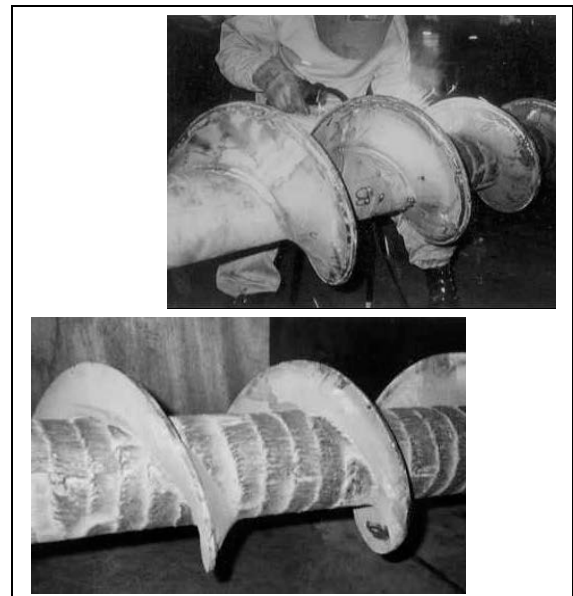

Photo 8.2 — GSMAW with a high-Cr iron type flux-cored wire (DW-H30MV), hardfacing a screw conveyor

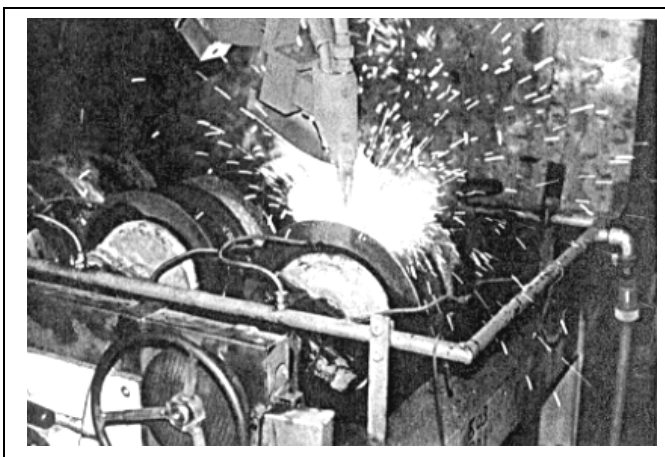

Photo 8.3 — Robotic GMAW with a pearlitic type flux-cored wire (DW-H350), hardfacing bulldozer track rollers of medium-C, 1%Mn steel

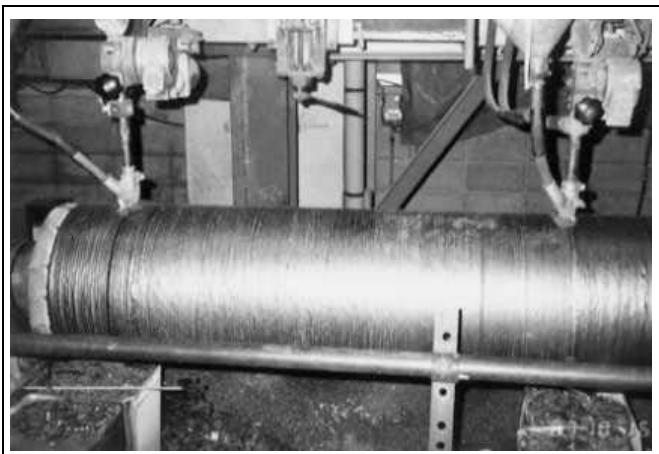

Photo 8.4 — SAW with a martensitic type flux-cored wire (US-H600N) and a fused flux (MF-30), hardfacing a steel mill roller

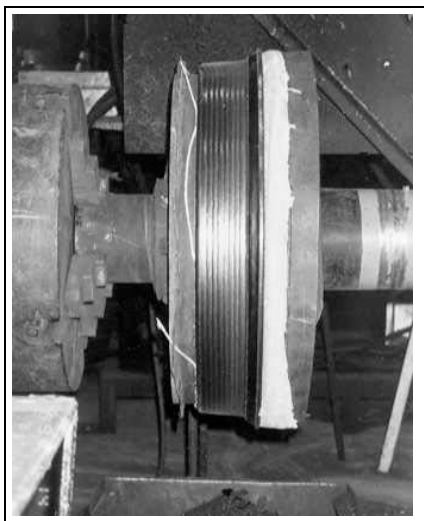

Photo 8.5 — SAW with a martensitic type flux-cored wire (US-H400N), hardfacing a railroad vehicle wheel of low-alloy steel

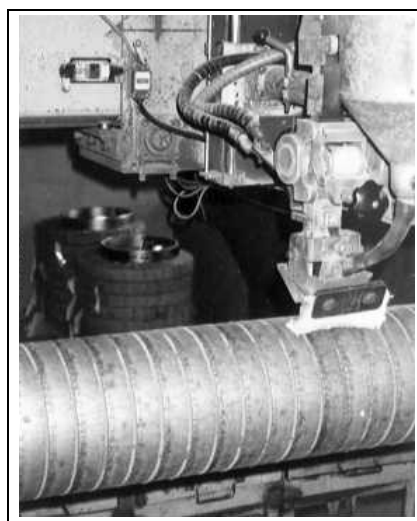

Photo 8.6 — SAW with a 13%Cr-2%Ni type strip (US-B410) and a bonded flux (PF-B131S), hardfacing a continuous casting roller

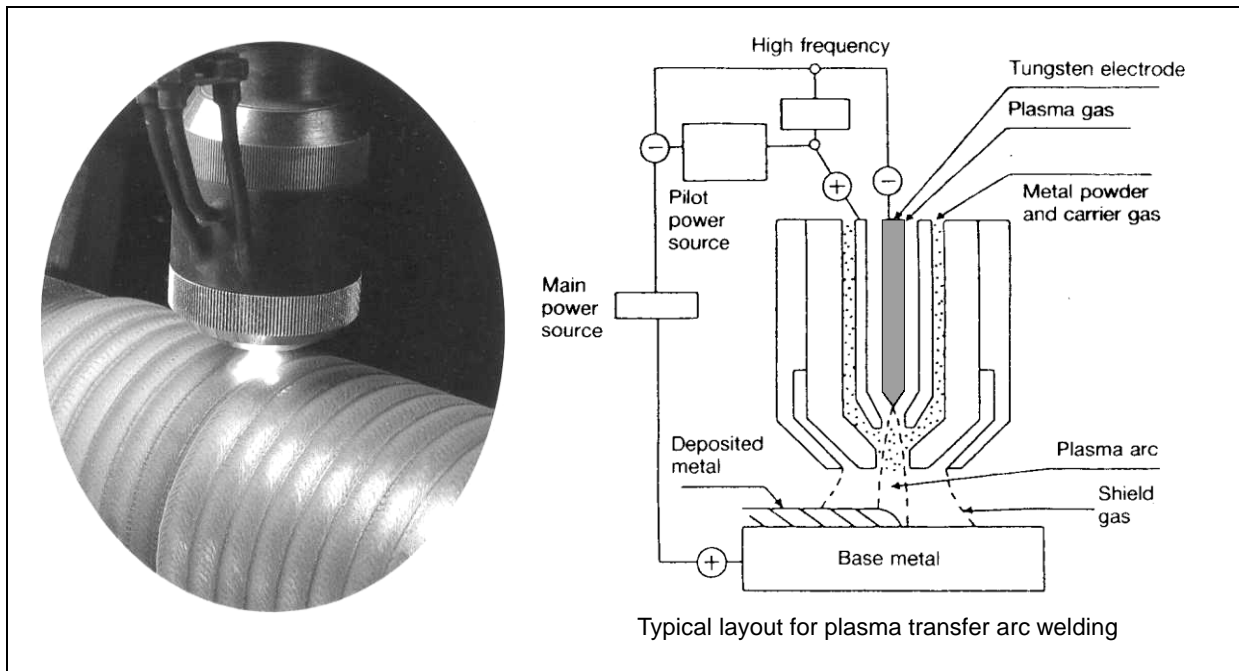

Photo 8.7 — PTAW with a Co-Cr-W alloy powder, hardfacing a mill roller of medium-C steel

